

3 Riverwood Grove

Created on
2018-02-26

Floors
1

▼ Ground Floor

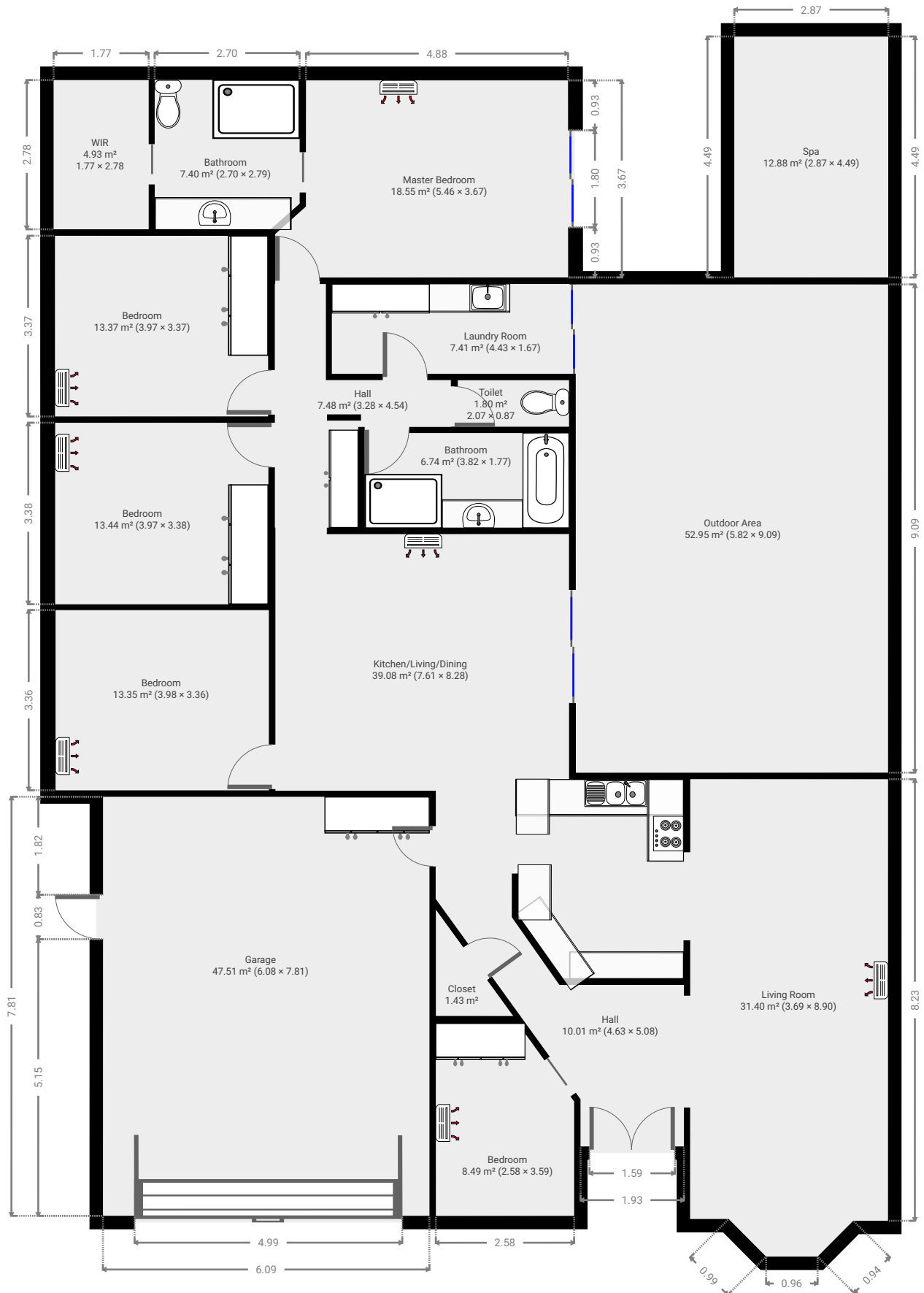

▼ Toilet Ground Floor

WIDTH: 2.07 m • LENGTH: 0.87 m
AREA: 1.80 m² • PERIMETER: 5.88 m

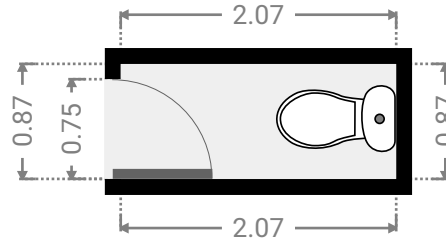
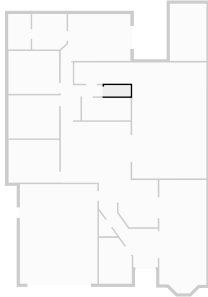

▼ Spa Ground Floor

WIDTH: 2.87 m • LENGTH: 4.49 m
AREA: 12.88 m² • PERIMETER: 14.72 m

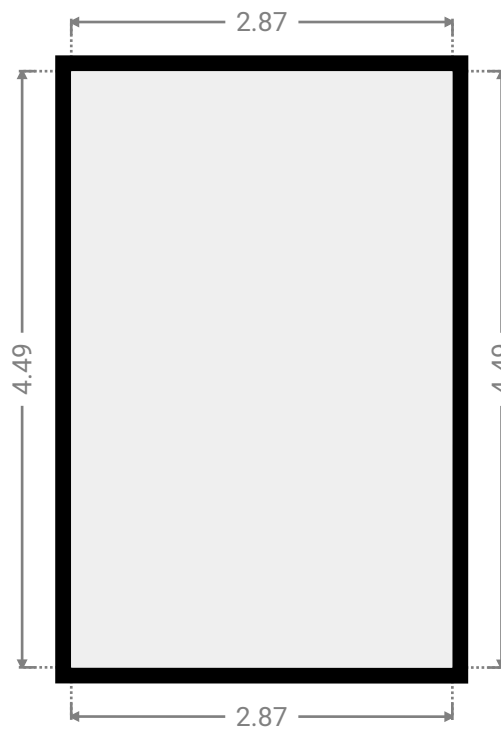
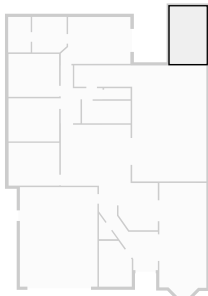

▼ Outdoor Area Ground Floor

WIDTH: 5.82 m • LENGTH: 9.09 m
AREA: 52.95 m² • PERIMETER: 29.84 m

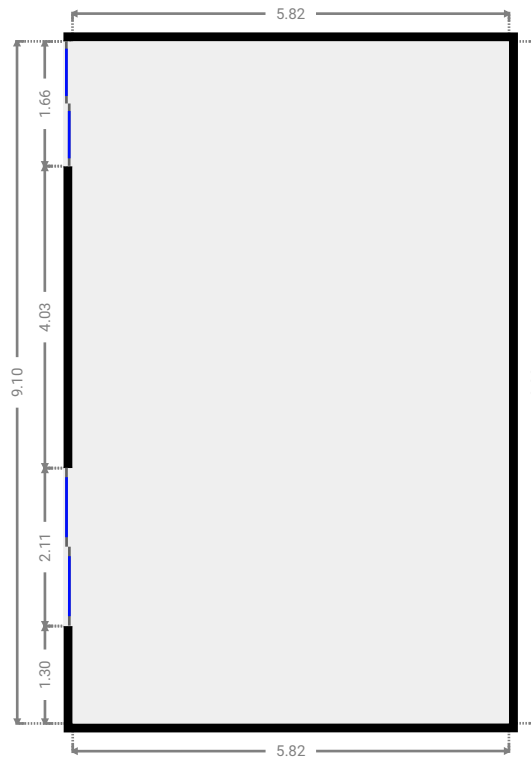
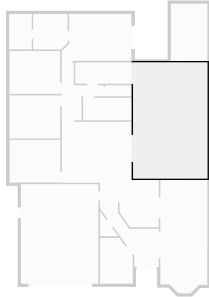

▼ WIR Ground Floor

WIDTH: 1.77 m • LENGTH: 2.78 m
AREA: 4.93 m² • PERIMETER: 9.10 m

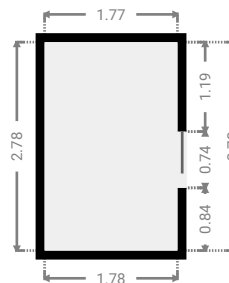
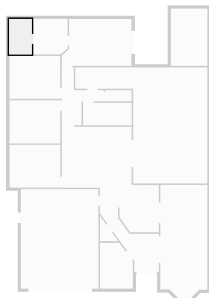

▼ Bathroom Ground Floor

WIDTH: 2.70 m • LENGTH: 2.79 m
AREA: 7.40 m² • PERIMETER: 10.68 m

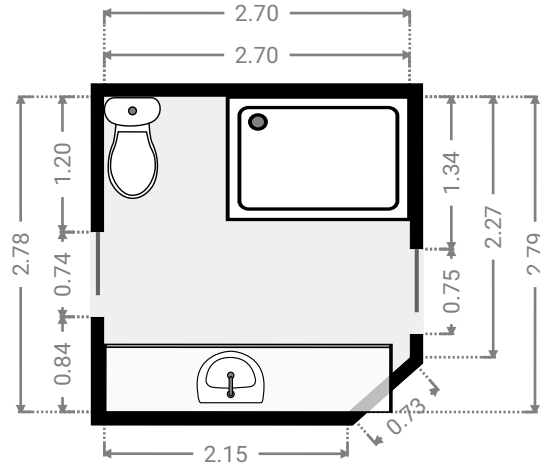
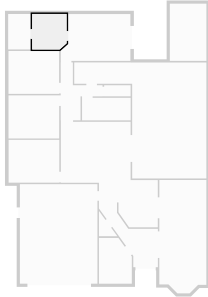

▼ Master Bedroom Ground Floor

WIDTH: 5.46 m • LENGTH: 3.67 m
AREA: 18.55 m² • PERIMETER: 17.95 m

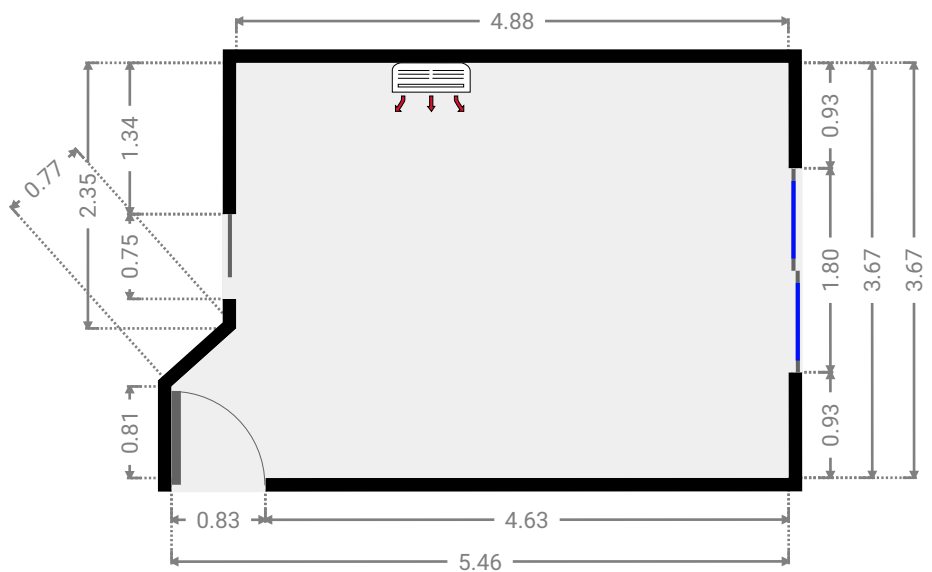
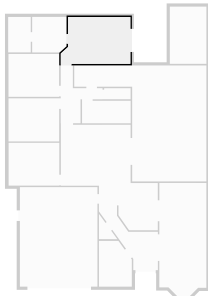

▼ Bedroom Ground Floor

WIDTH: 3.97 m • LENGTH: 3.37 m
AREA: 13.37 m² • PERIMETER: 14.68 m

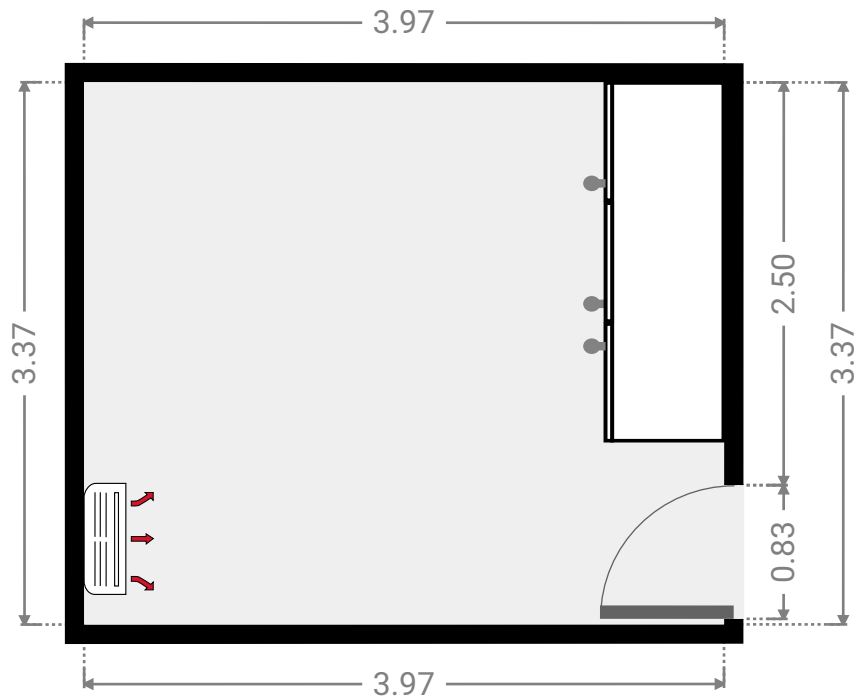
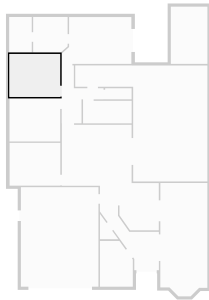

▼ Bedroom Ground Floor

WIDTH: 3.97 m • LENGTH: 3.38 m
AREA: 13.44 m² • PERIMETER: 14.71 m

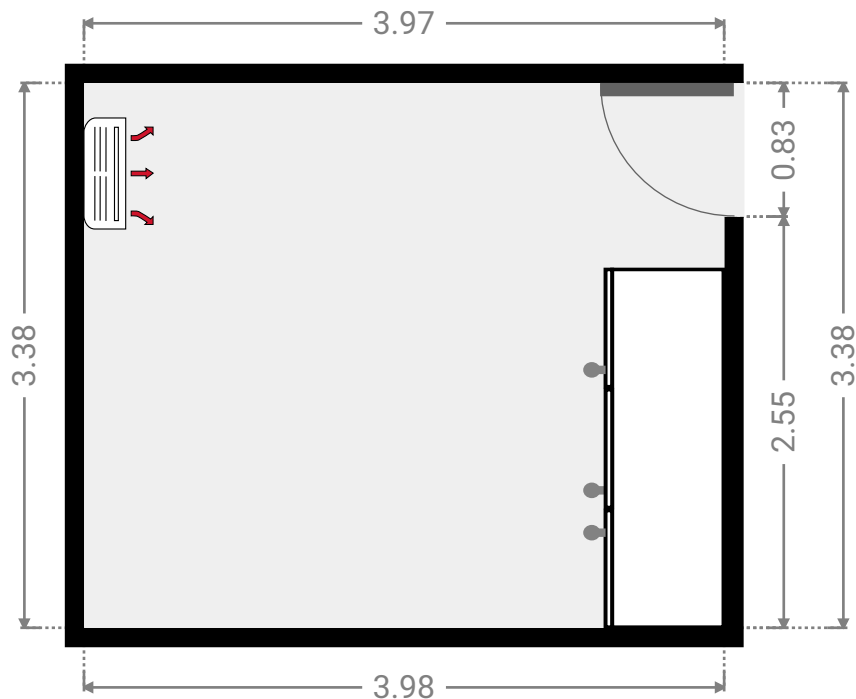
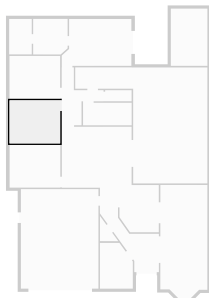

▼ Laundry Room Ground Floor

WIDTH: 4.43 m • LENGTH: 1.67 m
AREA: 7.41 m² • PERIMETER: 12.21 m

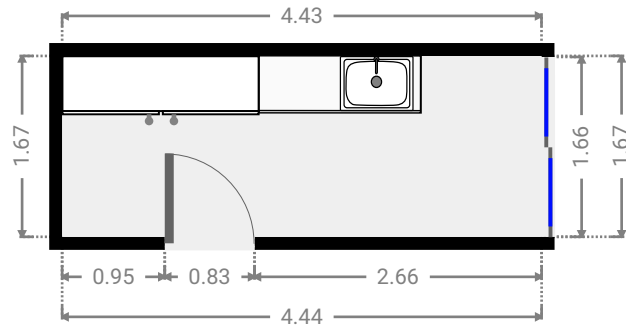
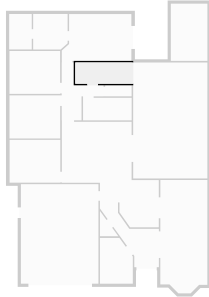

▼ Hall Ground Floor

WIDTH: 4.63 m • LENGTH: 5.08 m
AREA: 10.01 m² • PERIMETER: 16.99 m

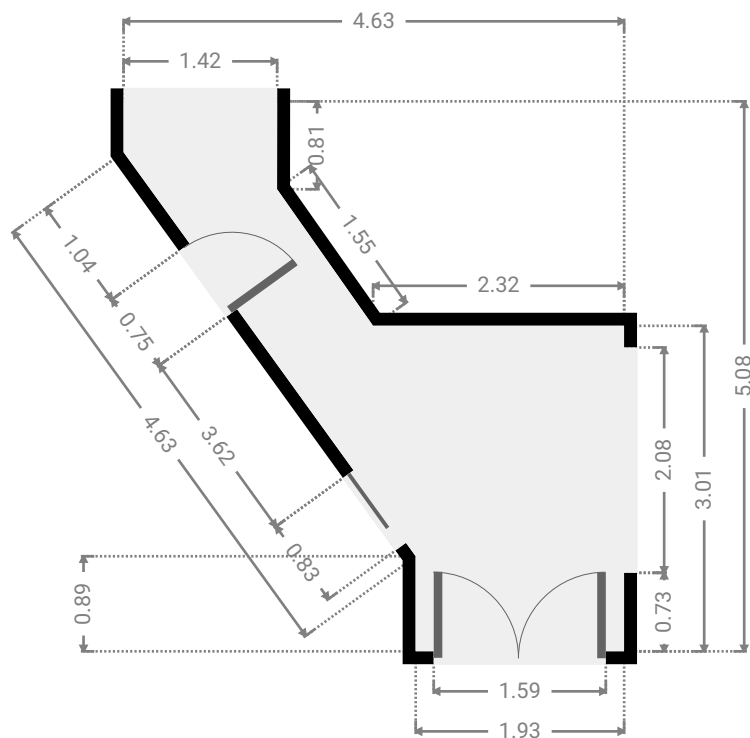
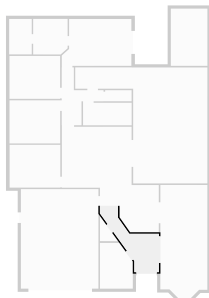

▼ Bathroom Ground Floor

WIDTH: 3.82 m • LENGTH: 1.77 m
AREA: 6.74 m² • PERIMETER: 11.17 m

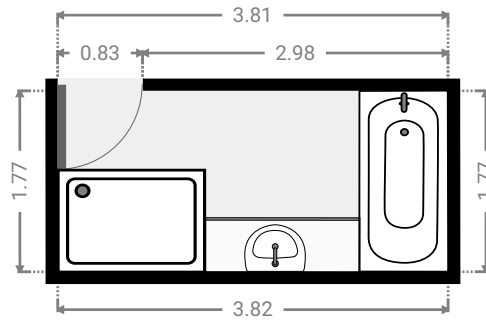
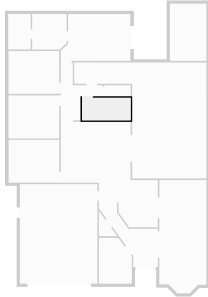

▼ Hall Ground Floor

WIDTH: 3.28 m • LENGTH: 4.54 m
AREA: 7.48 m² • PERIMETER: 15.64 m

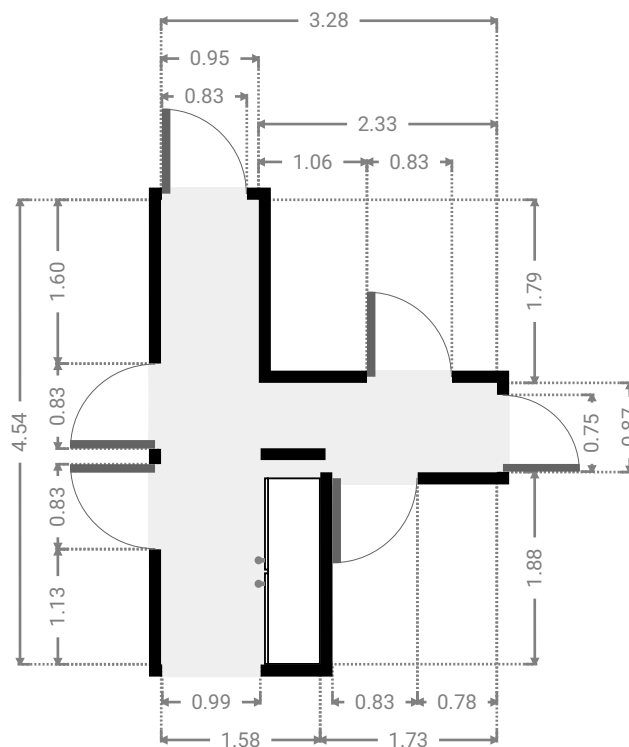
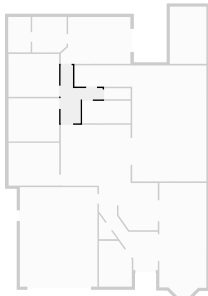

▼ Bedroom Ground Floor

WIDTH: 3.98 m • LENGTH: 3.36 m
AREA: 13.35 m² • PERIMETER: 14.67 m

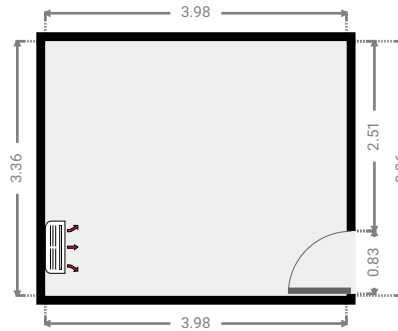
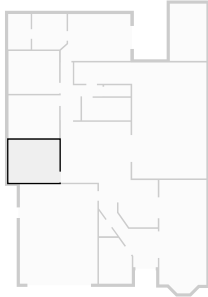

▼ Kitchen/Living/Dining Ground Floor

WIDTH: 7.61 m • LENGTH: 8.28 m
AREA: 39.08 m² • PERIMETER: 31.20 m

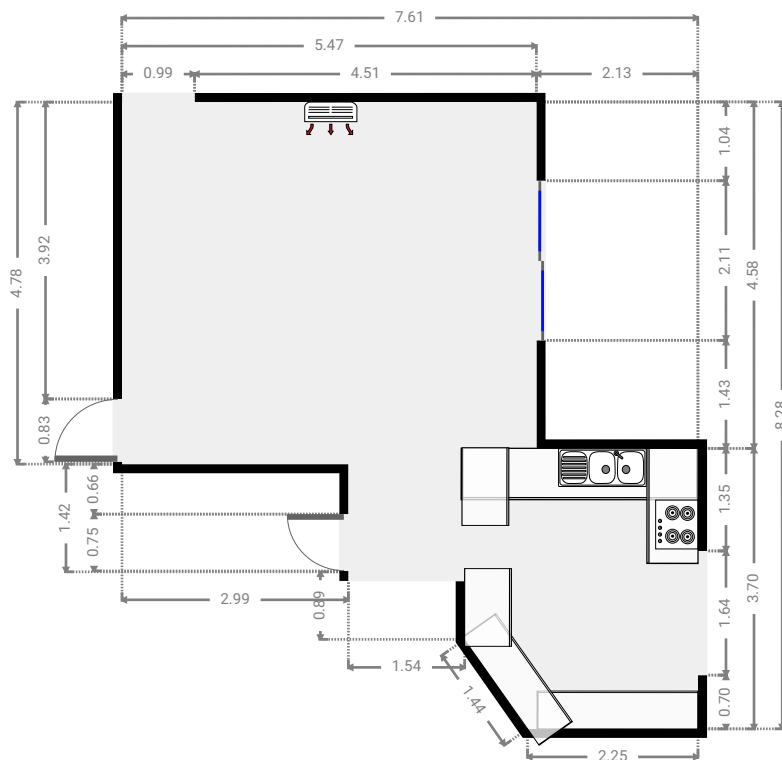
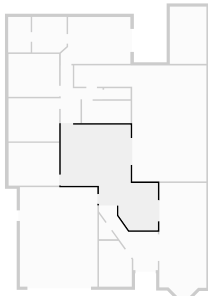

▼ **Closet**
Ground Floor

WIDTH: 1.44 m • LENGTH: 1.98 m
AREA: 1.43 m² • PERIMETER: 5.87 m

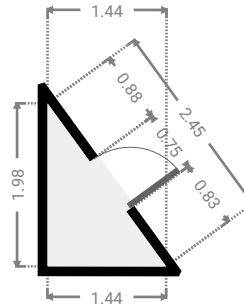
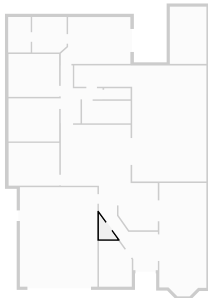

▼ **Garage**
Ground Floor

WIDTH: 6.08 m • LENGTH: 7.81 m
AREA: 47.51 m² • PERIMETER: 27.79 m

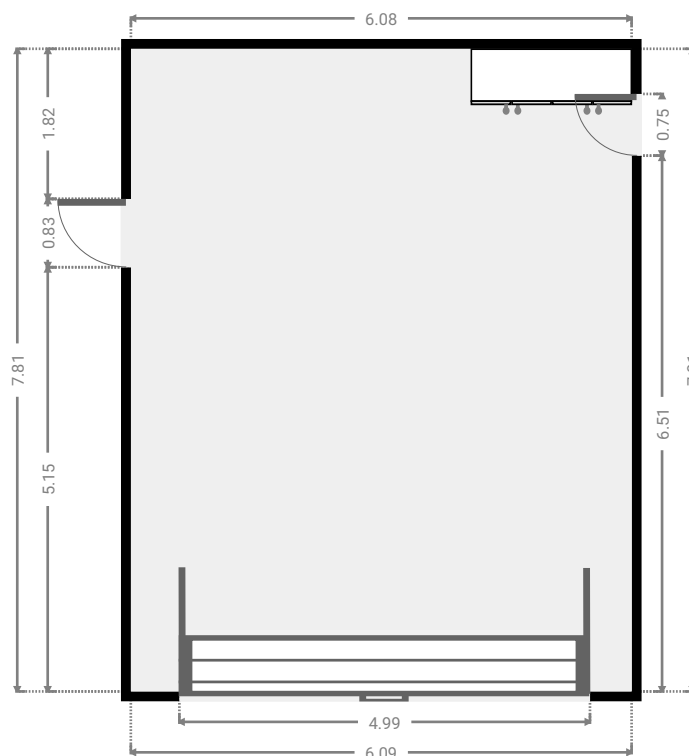
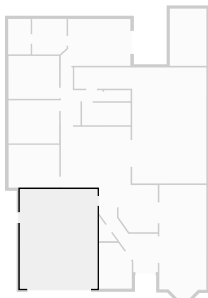

▼ **Bedroom**
Ground Floor

WIDTH: 2.58 m • LENGTH: 3.59 m
AREA: 8.49 m² • PERIMETER: 11.63 m

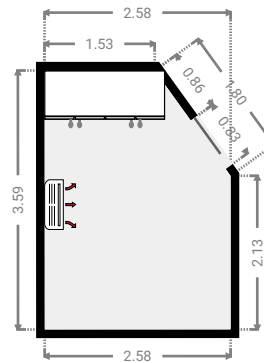
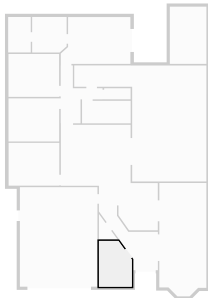

▼ **Living Room**
Ground Floor

WIDTH: 3.69 m • LENGTH: 8.90 m
AREA: 31.40 m² • PERIMETER: 24.37 m

