

# 3 Red Penda

Created on  
2021-07-22

Floors  
1



## ▼ Ground Floor

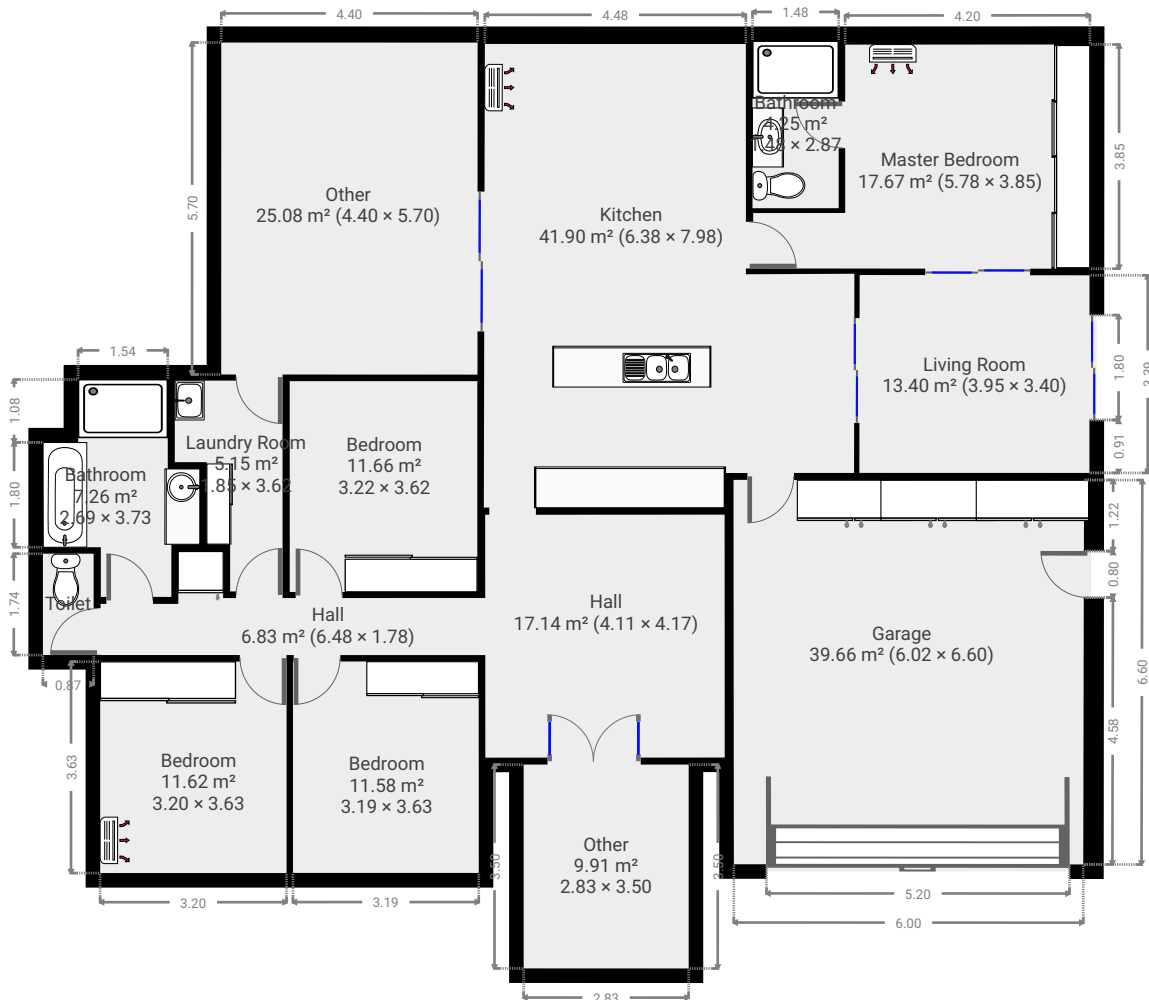
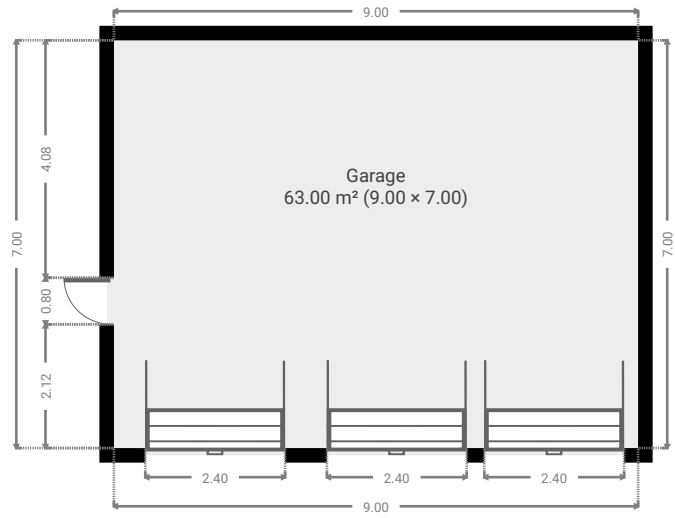

## ▼ Kitchen Ground Floor

WIDTH: 6.38 m • LENGTH: 7.98 m  
AREA: 41.90 m<sup>2</sup> • PERIMETER: 28.64 m

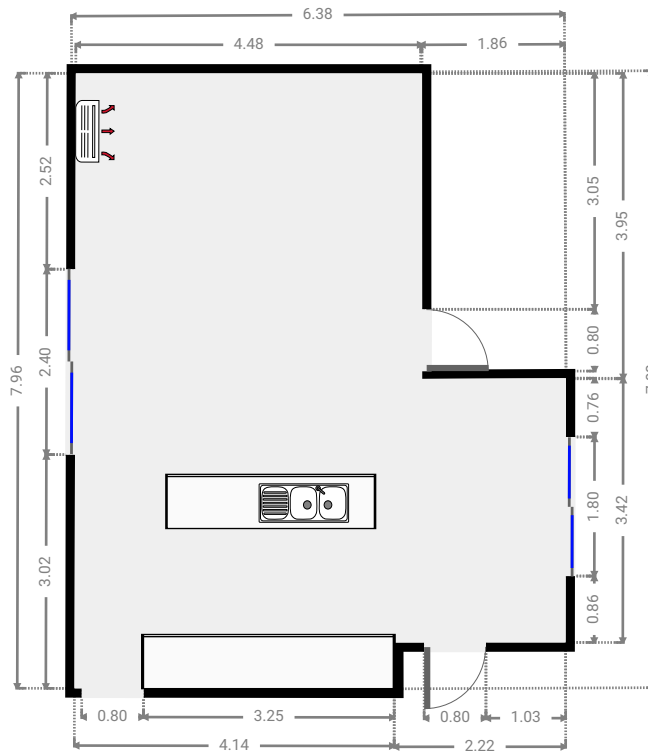
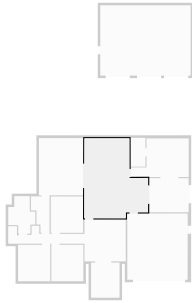

## ▼ Hall Ground Floor

WIDTH: 4.11 m • LENGTH: 4.17 m  
AREA: 17.14 m<sup>2</sup> • PERIMETER: 16.56 m

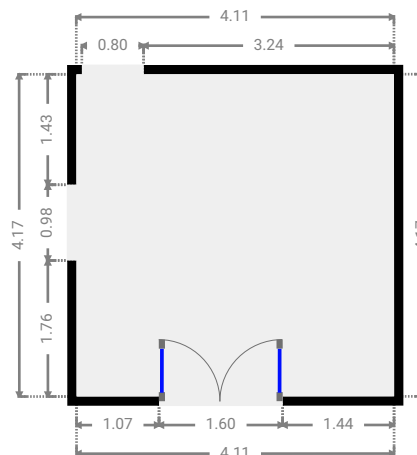
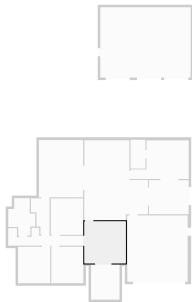

▼ **Hall**  
Ground Floor

WIDTH: 6.48 m • LENGTH: 1.78 m  
AREA: 6.83 m<sup>2</sup> • PERIMETER: 16.53 m

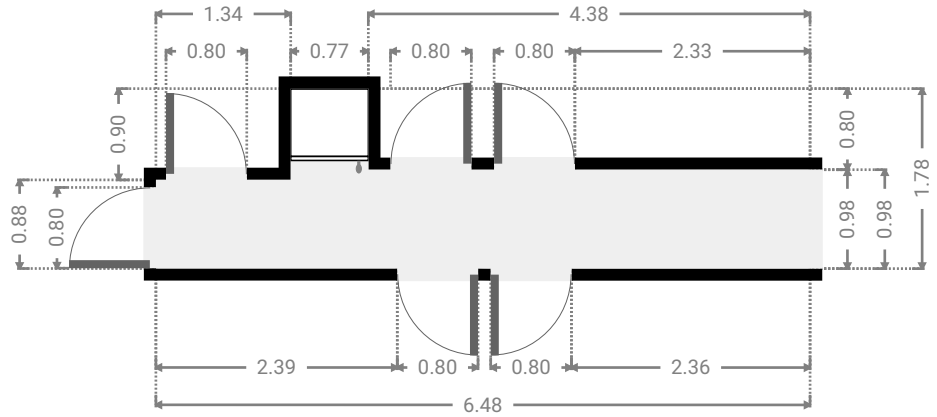

▼ **Bedroom**  
Ground Floor

WIDTH: 3.19 m • LENGTH: 3.63 m  
AREA: 11.58 m<sup>2</sup> • PERIMETER: 13.64 m

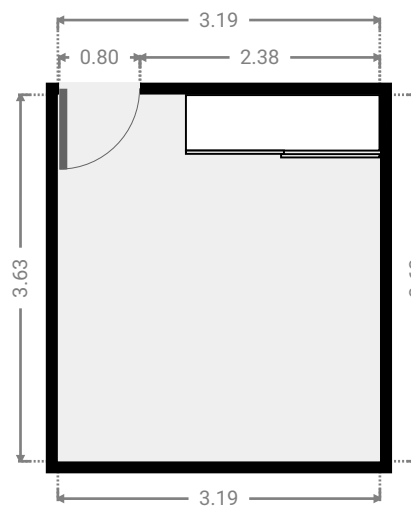

## ▼ Bedroom Ground Floor

WIDTH: 3.22 m • LENGTH: 3.62 m  
AREA: 11.66 m<sup>2</sup> • PERIMETER: 13.68 m

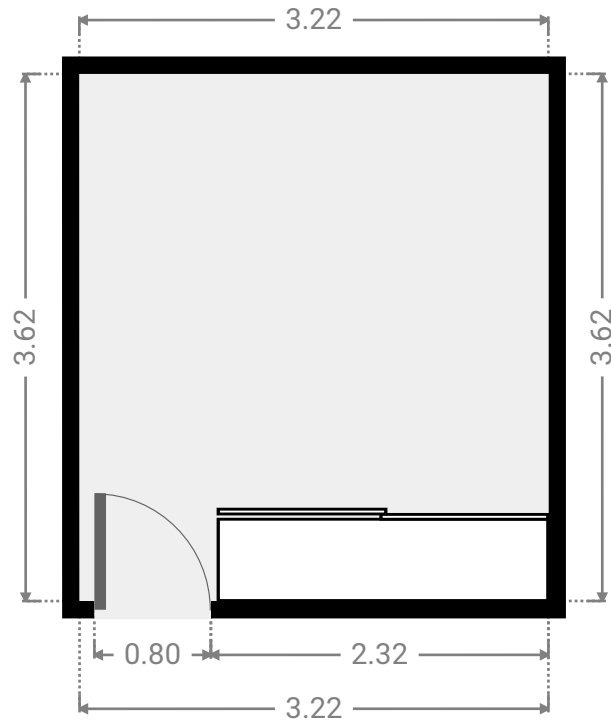
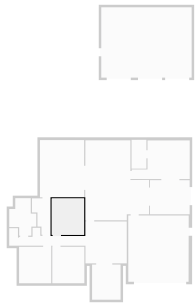

## ▼ Bedroom Ground Floor

WIDTH: 3.20 m • LENGTH: 3.63 m  
AREA: 11.62 m<sup>2</sup> • PERIMETER: 13.66 m

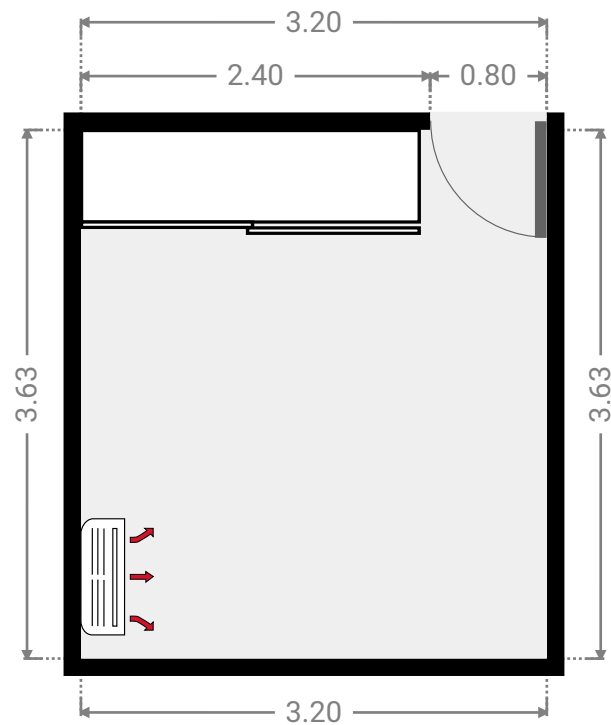

## ▼ Laundry Room Ground Floor

WIDTH: 1.85 m • LENGTH: 3.62 m  
AREA: 5.15 m<sup>2</sup> • PERIMETER: 10.94 m

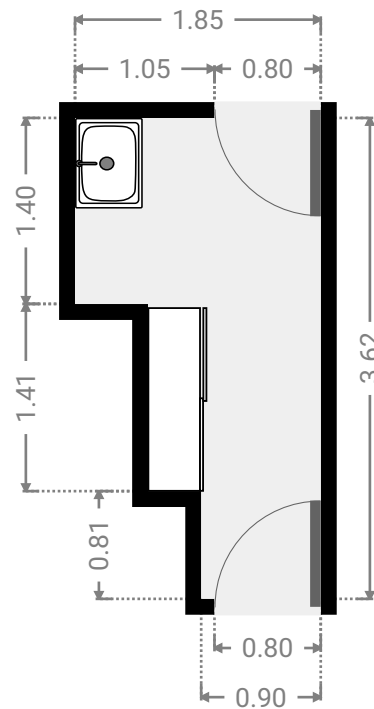
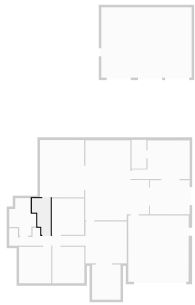

## ▼ Bathroom Ground Floor

WIDTH: 2.69 m • LENGTH: 3.73 m  
AREA: 7.26 m<sup>2</sup> • PERIMETER: 12.84 m

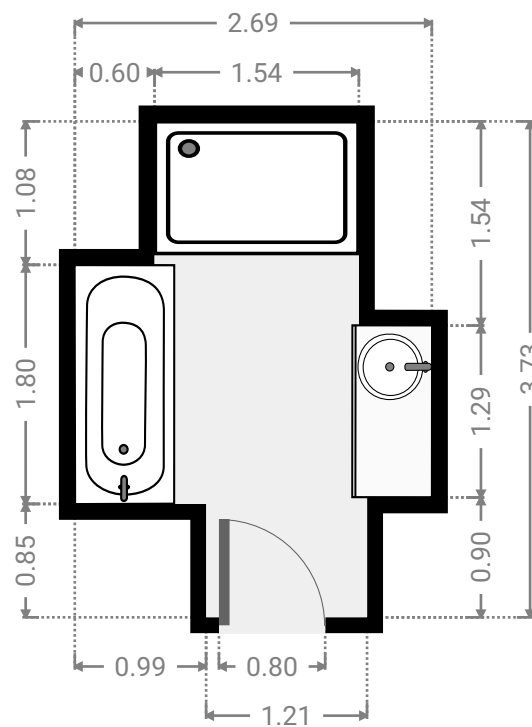
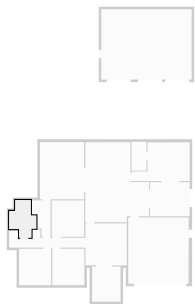

## ▼ Toilet Ground Floor

WIDTH: 0.87 m • LENGTH: 1.74 m  
AREA: 1.51 m<sup>2</sup> • PERIMETER: 5.22 m

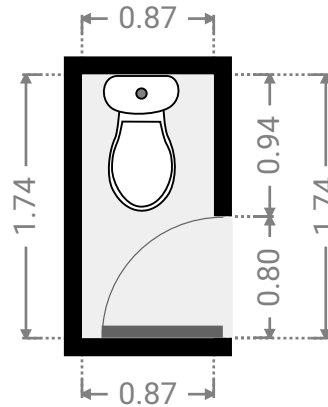
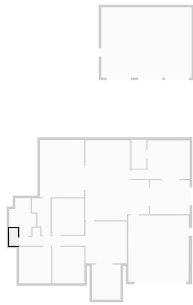

## ▼ Living Room Ground Floor

WIDTH: 3.95 m • LENGTH: 3.40 m  
AREA: 13.40 m<sup>2</sup> • PERIMETER: 14.68 m

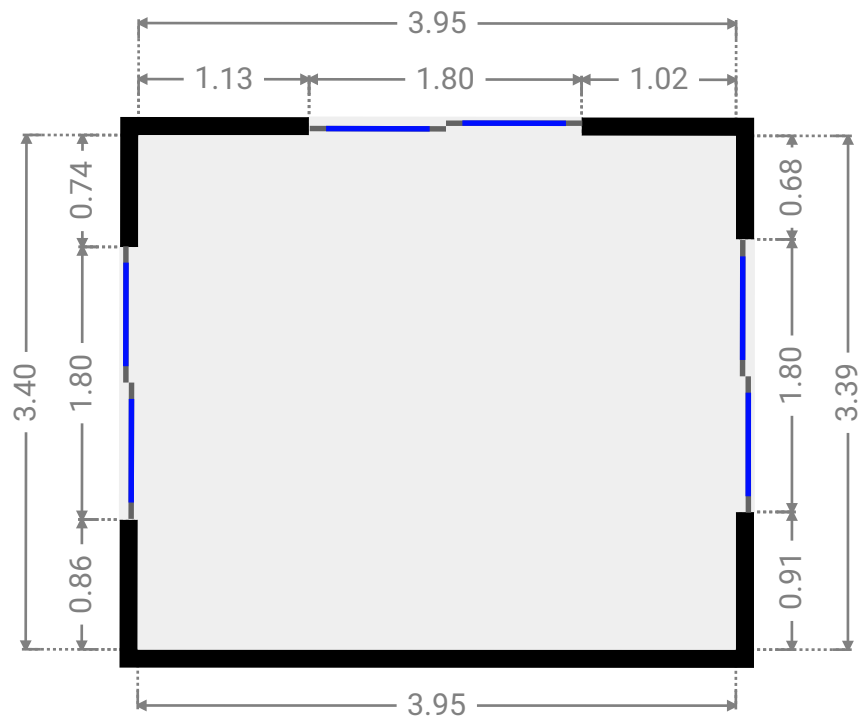

## ▼ Master Bedroom Ground Floor

WIDTH: 5.78 m • LENGTH: 3.85 m  
AREA: 17.67 m<sup>2</sup> • PERIMETER: 19.26 m

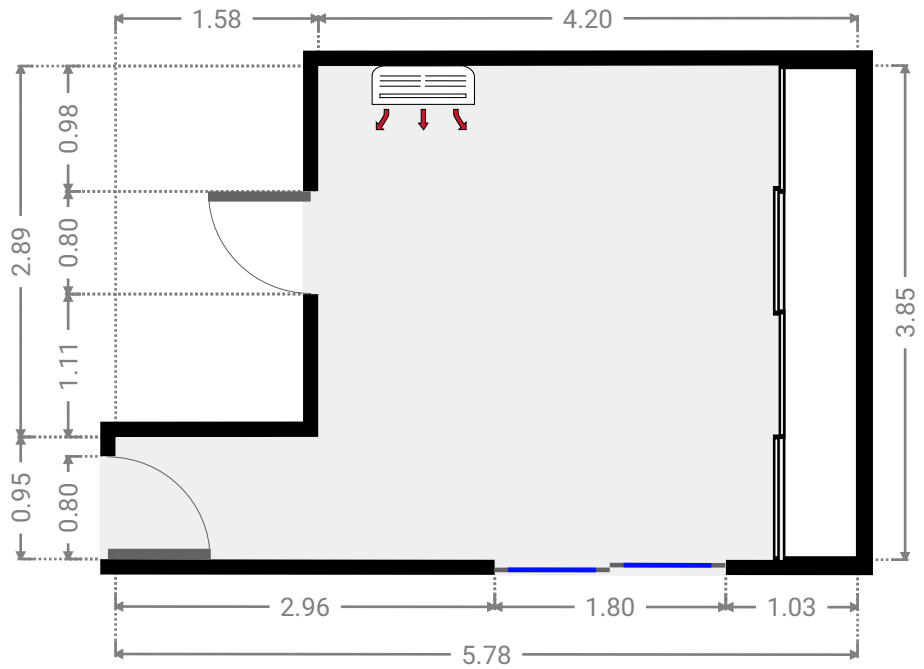
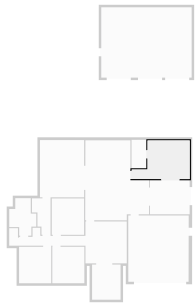

## ▼ Bathroom Ground Floor

WIDTH: 1.48 m • LENGTH: 2.87 m  
AREA: 4.25 m<sup>2</sup> • PERIMETER: 8.70 m

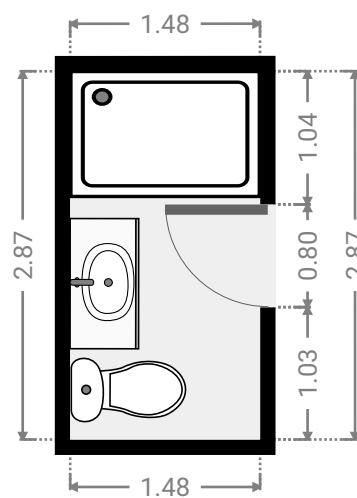
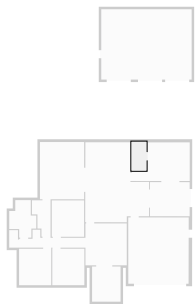



# 3 Red Penda

FLOORS: 1

## ▼ Other Ground Floor

WIDTH: 4.40 m • LENGTH: 5.70 m  
AREA: 25.08 m<sup>2</sup> • PERIMETER: 20.20 m

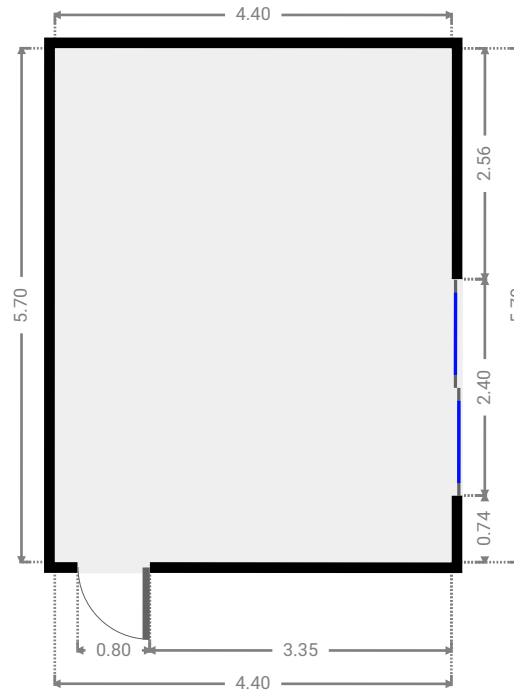
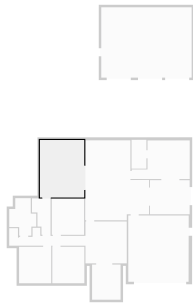

## ▼ Garage Ground Floor

WIDTH: 6.02 m • LENGTH: 6.60 m  
AREA: 39.66 m<sup>2</sup> • PERIMETER: 25.22 m

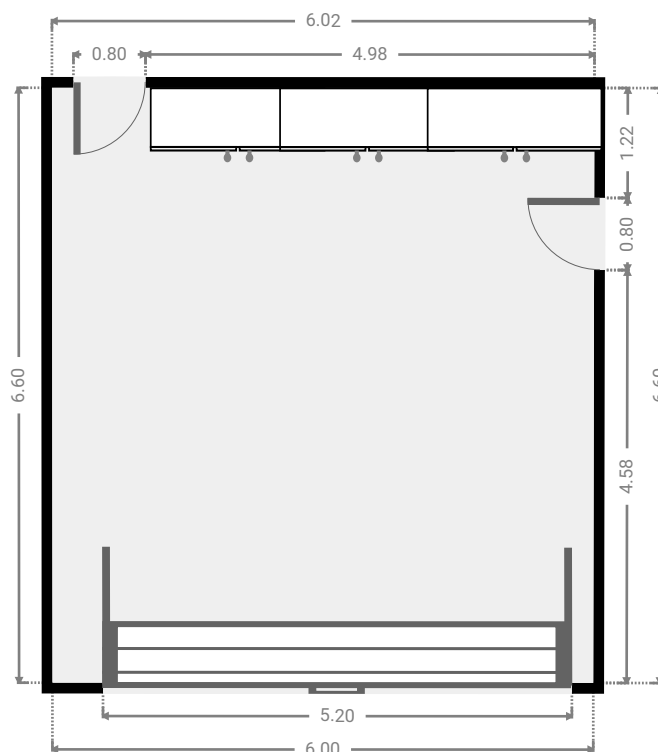
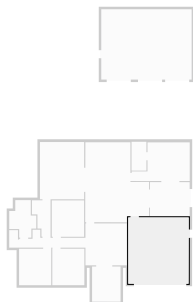

# 3 Red Penda

FLOORS: 1

## ▼ Garage Ground Floor

WIDTH: 9.00 m • LENGTH: 7.00 m  
AREA: 63.00 m<sup>2</sup> • PERIMETER: 32.00 m

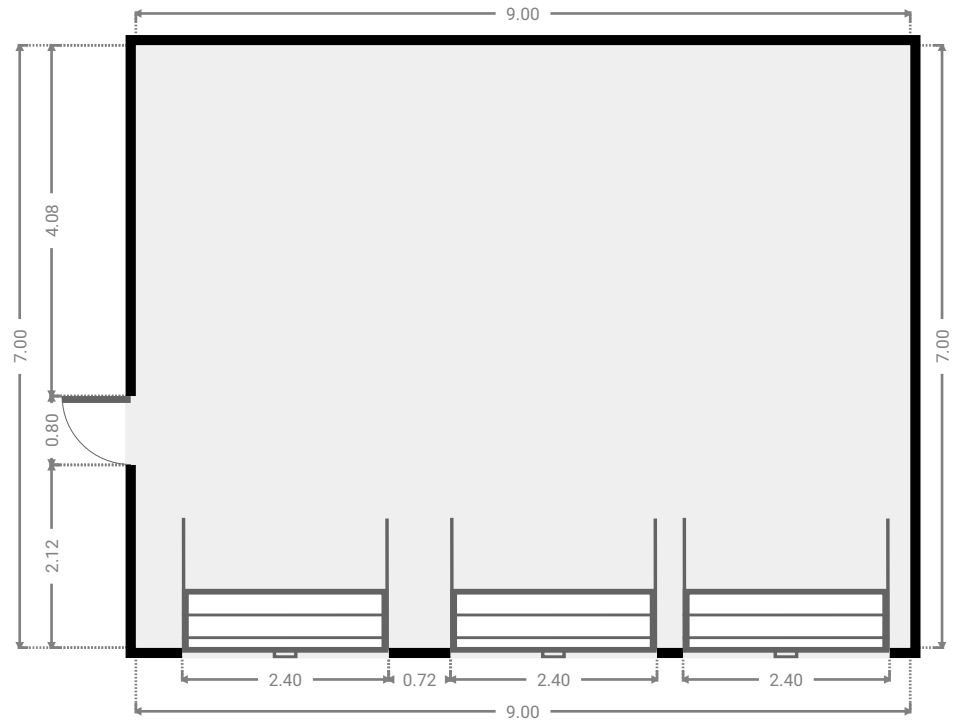
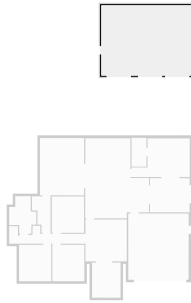

## ▼ Other Ground Floor

WIDTH: 2.83 m • LENGTH: 3.50 m  
AREA: 9.91 m<sup>2</sup> • PERIMETER: 12.67 m

