

3 Quarrion

SUBMITTED BY
Ray White Rockhampton Casey
stockers@cqoz.com

CREATED ON
2022-09-28

Floors
1

▼ Ground Floor



3 Quarrion

FLOORS: 1

▼ Bathroom Ground Floor

WIDTH: 3.40 m • LENGTH: 4.22 m
AREA: 14.35 m² • PERIMETER: 15.24 m

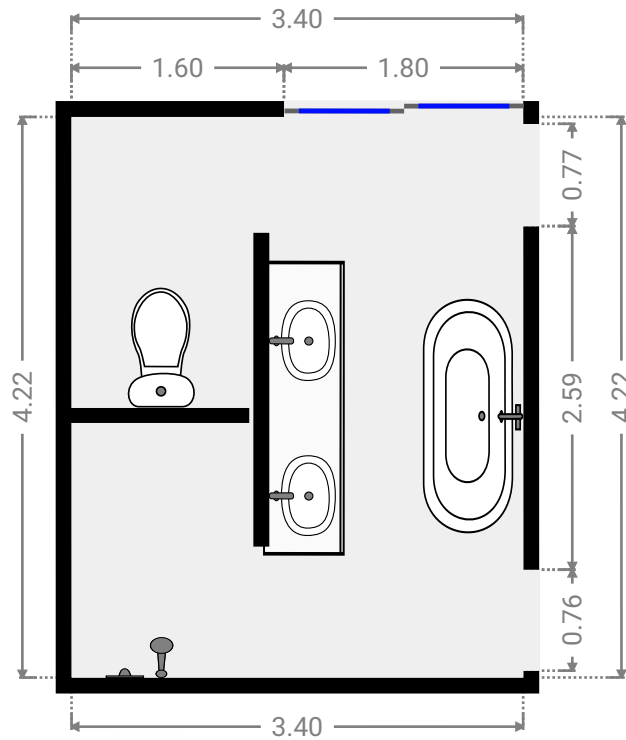

▼ Bathroom Ground Floor

WIDTH: 3.16 m • LENGTH: 2.50 m
AREA: 7.90 m² • PERIMETER: 11.32 m

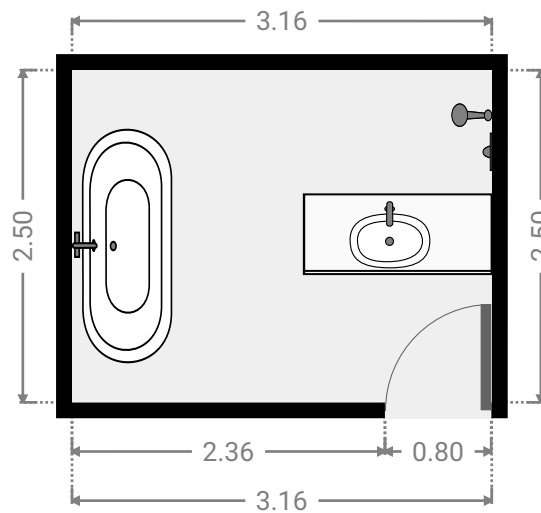

3 Quarrion

FLOORS: 1

▼ Bedroom Ground Floor

WIDTH: 3.44 m • LENGTH: 4.36 m
AREA: 13.90 m² • PERIMETER: 15.58 m

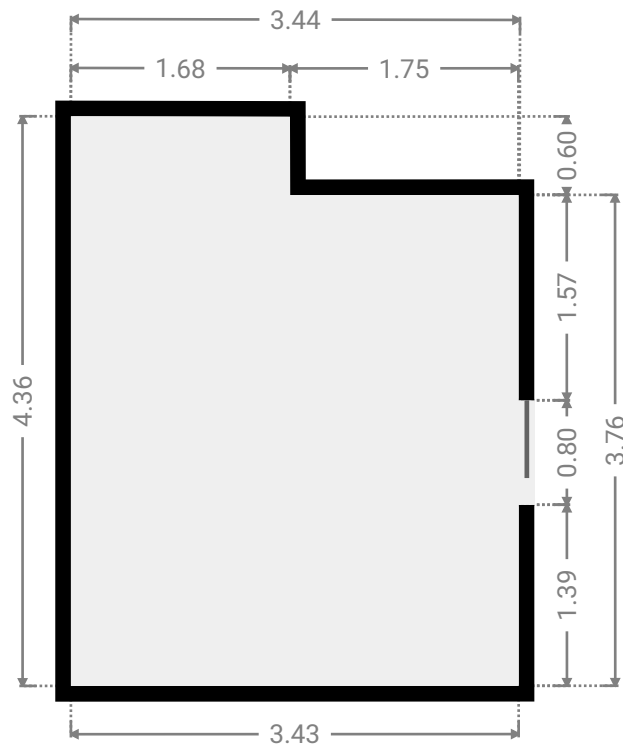

▼ Bedroom Ground Floor

WIDTH: 3.17 m • LENGTH: 3.88 m
AREA: 12.30 m² • PERIMETER: 14.10 m

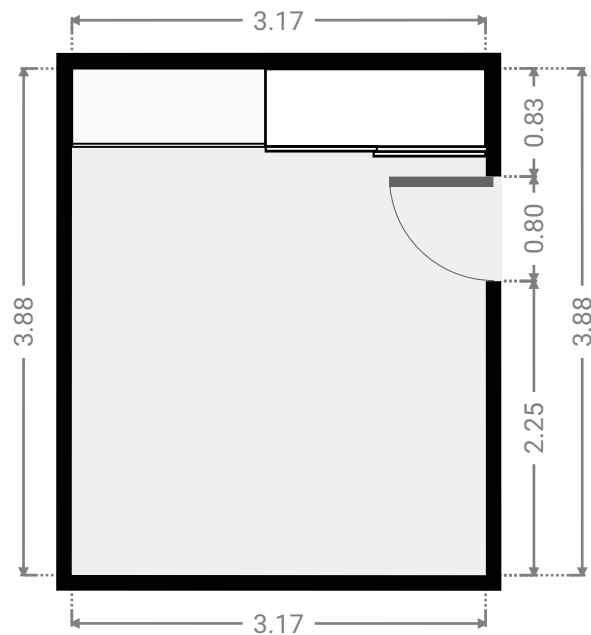

3 Quarrion

FLOORS: 1

▼ Bedroom Ground Floor

WIDTH: 3.17 m • LENGTH: 3.88 m
AREA: 12.30 m² • PERIMETER: 14.10 m

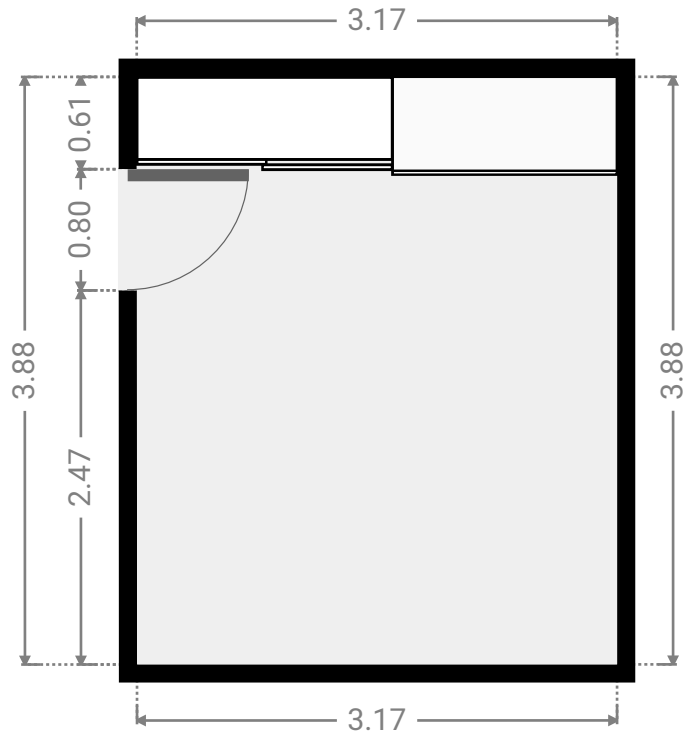

▼ Bedroom Ground Floor

WIDTH: 4.25 m • LENGTH: 3.17 m
AREA: 13.47 m² • PERIMETER: 14.84 m

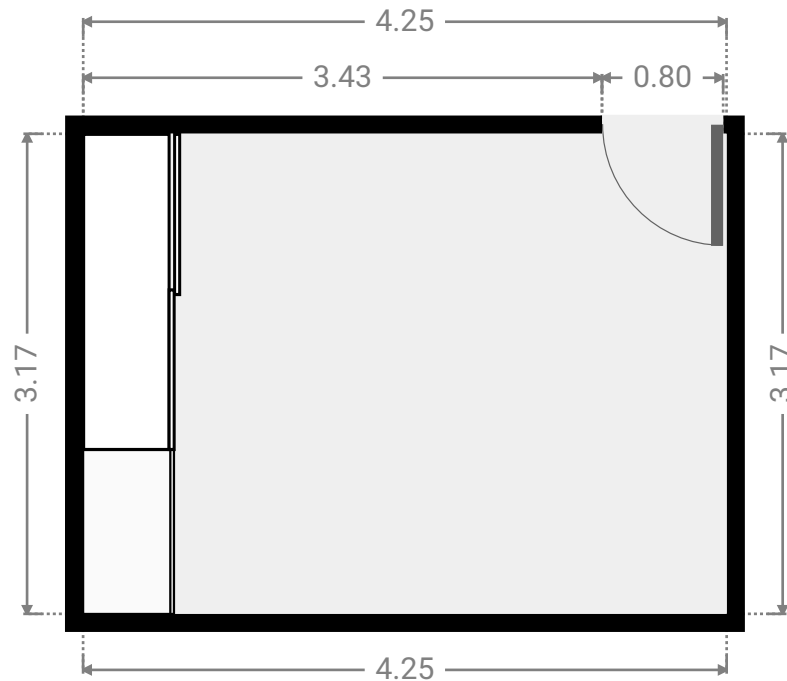

▼ Closet Ground Floor

WIDTH: 4.20 m • LENGTH: 2.08 m
AREA: 8.74 m² • PERIMETER: 12.56 m

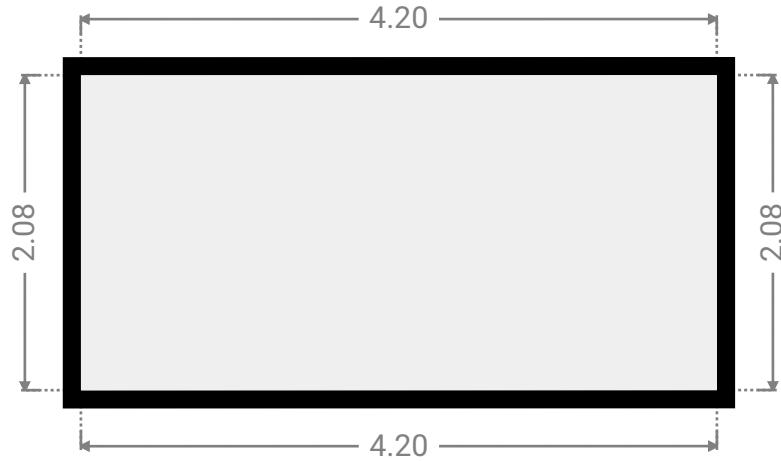

▼ Closet Ground Floor

WIDTH: 3.30 m • LENGTH: 3.44 m
AREA: 11.35 m² • PERIMETER: 13.48 m

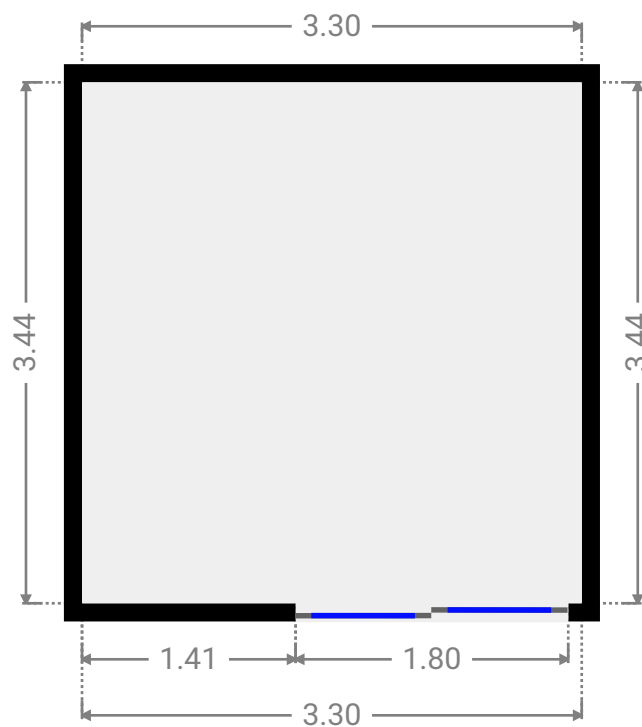

3 Qarrion

FLOORS: 1

▼ Garage Ground Floor

WIDTH: 7.45 m • LENGTH: 6.20 m
AREA: 42.38 m² • PERIMETER: 27.29 m

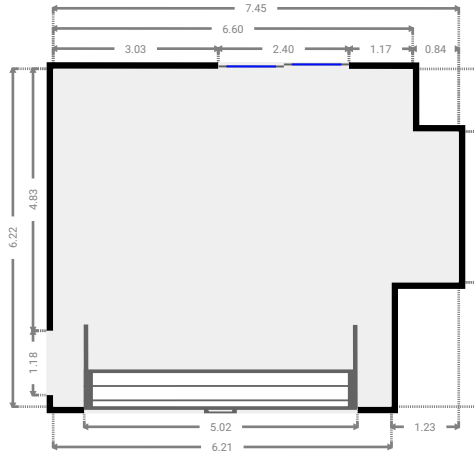

▼ Garage Ground Floor

WIDTH: 6.42 m • LENGTH: 11.51 m
AREA: 51.05 m² • PERIMETER: 32.61 m

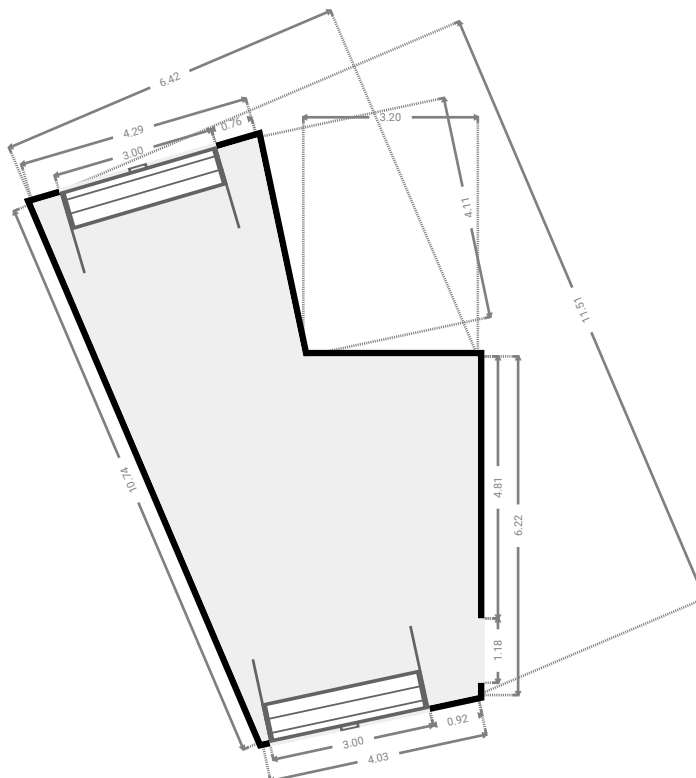

3 Quarrion

FLOORS: 1

▼ Hall Ground Floor

WIDTH: 6.55 m • LENGTH: 14.56 m
AREA: 72.51 m² • PERIMETER: 43.79 m

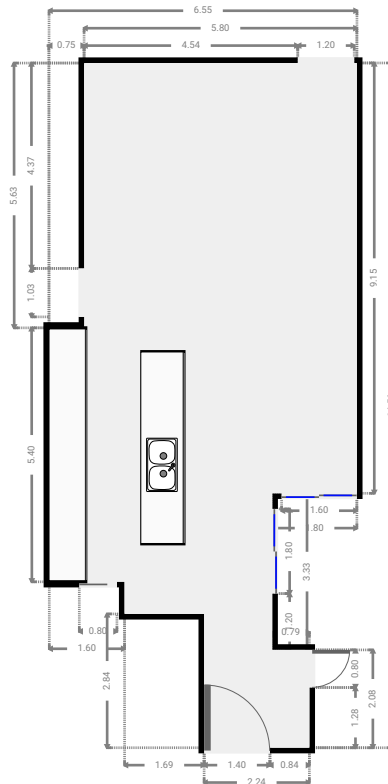

▼ Closet Ground Floor

WIDTH: 3.22 m • LENGTH: 1.62 m
AREA: 4.08 m² • PERIMETER: 9.67 m

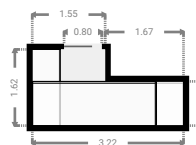

3 Quarrion

FLOORS: 1



▼ Hall Ground Floor

WIDTH: 3.85 m • LENGTH: 19.12 m
AREA: 25.37 m² • PERIMETER: 50.03 m

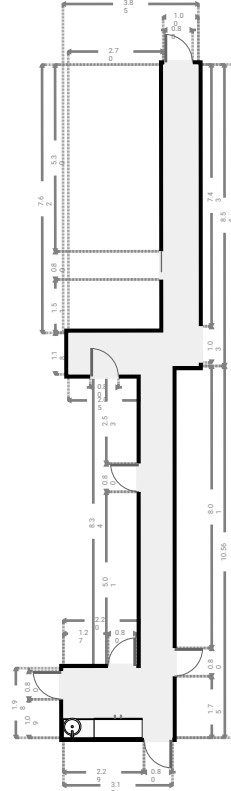

▼ Closet Ground Floor

WIDTH: 1.92 m • LENGTH: 1.44 m
AREA: 2.77 m² • PERIMETER: 6.72 m

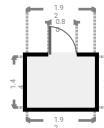

3 Quarrion

FLOORS: 1

▼ Laundry Room Ground Floor

WIDTH: 3.42 m • LENGTH: 2.38 m
AREA: 7.04 m² • PERIMETER: 11.60 m

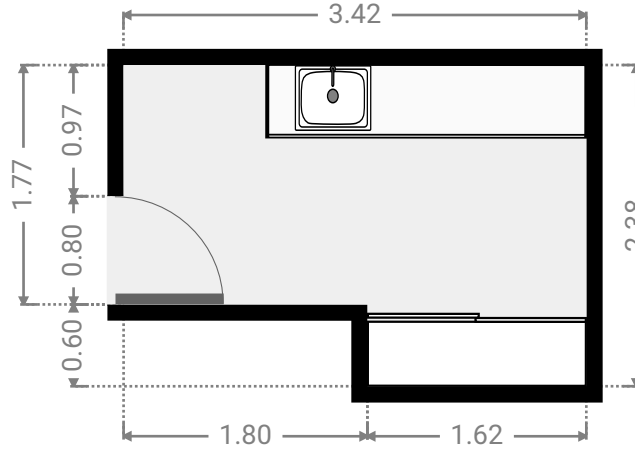

▼ Living Room Ground Floor

WIDTH: 5.80 m • LENGTH: 4.00 m
AREA: 23.19 m² • PERIMETER: 19.60 m

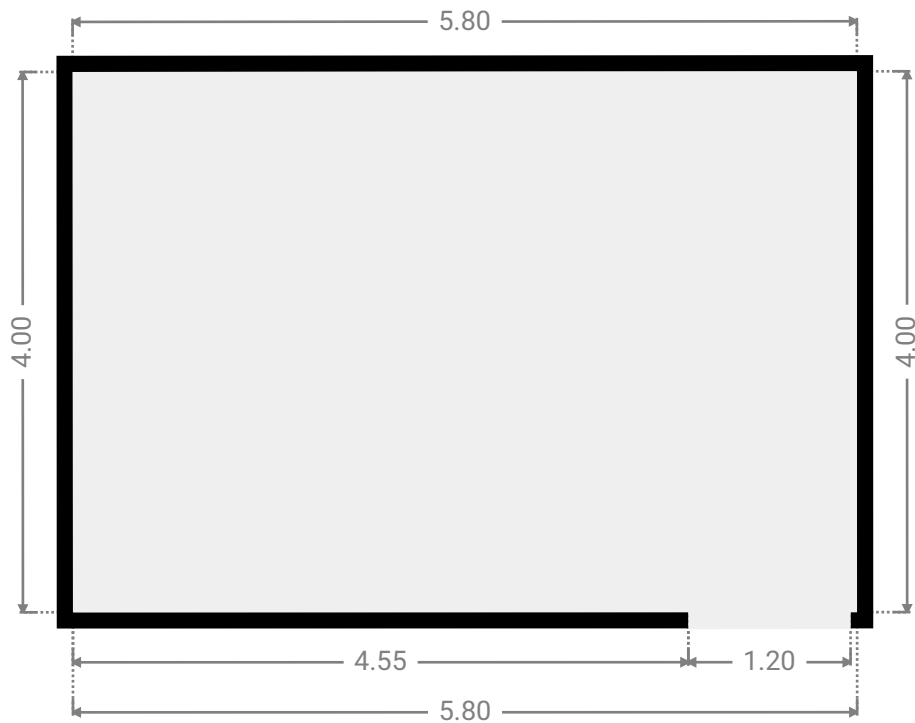

3 Quarrion

FLOORS: 1

▼ Other Ground Floor

WIDTH: 4.00 m • LENGTH: 6.00 m
AREA: 24.00 m² • PERIMETER: 20.00 m

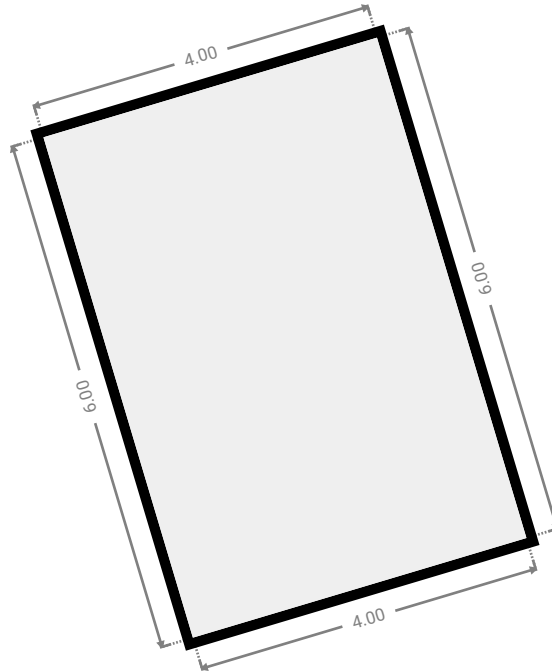

▼ Other Ground Floor

WIDTH: 6.00 m • LENGTH: 6.00 m
AREA: 36.01 m² • PERIMETER: 24.00 m

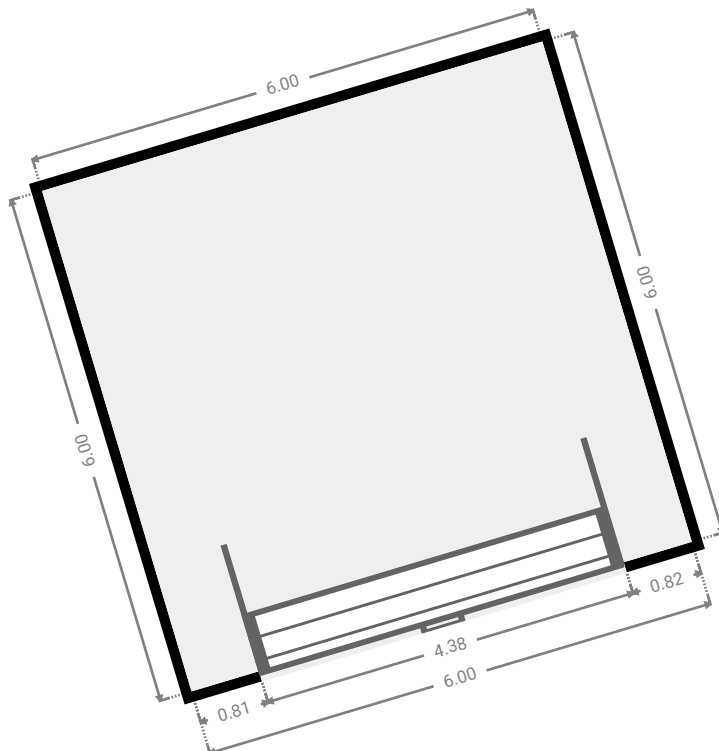

3 Quarrion

FLOORS: 1

▼ Other Ground Floor

WIDTH: 3.55 m • LENGTH: 3.73 m
AREA: 13.24 m² • PERIMETER: 14.56 m

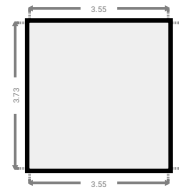

▼ Other Ground Floor

WIDTH: 10.29 m • LENGTH: 17.63 m
AREA: 153.11 m² • PERIMETER: 59.32 m

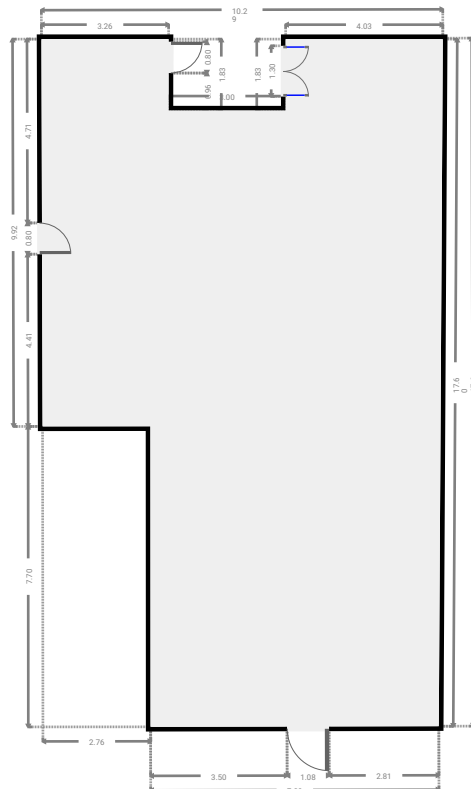
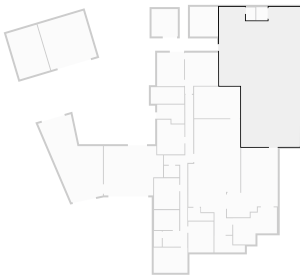

3 Quarrion

FLOORS: 1

▼ Closet Ground Floor

WIDTH: 1.44 m • LENGTH: 1.66 m
AREA: 2.39 m² • PERIMETER: 6.20 m

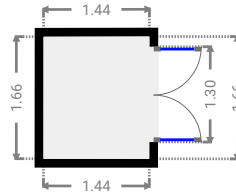

▼ Other Ground Floor

WIDTH: 6.40 m • LENGTH: 8.76 m
AREA: 41.58 m² • PERIMETER: 30.31 m

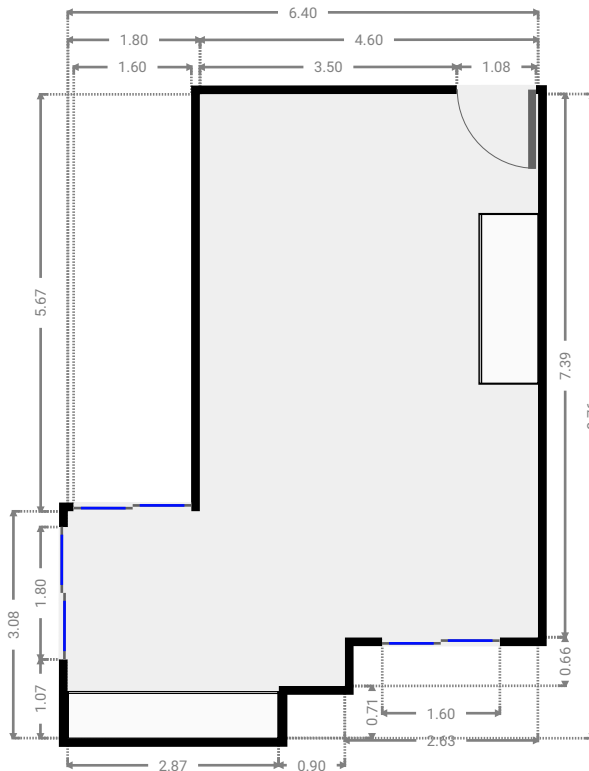

3 Quarrion

FLOORS: 1

▼ Other Ground Floor

WIDTH: 3.84 m • LENGTH: 2.10 m
AREA: 6.10 m² • PERIMETER: 11.85 m

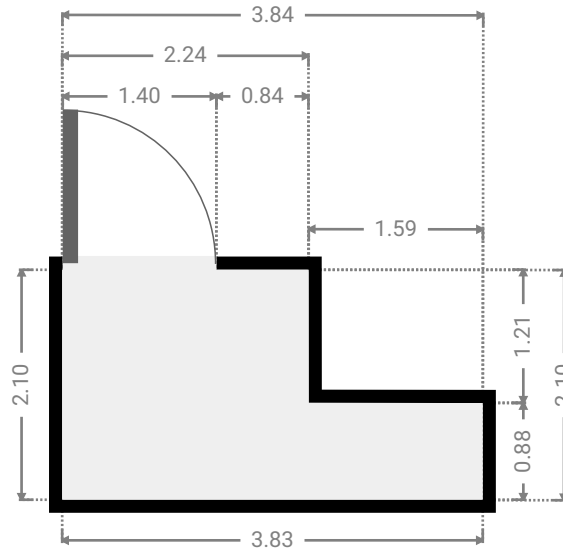

▼ Primary Bedroom Ground Floor

WIDTH: 4.22 m • LENGTH: 5.18 m
AREA: 18.61 m² • PERIMETER: 18.79 m

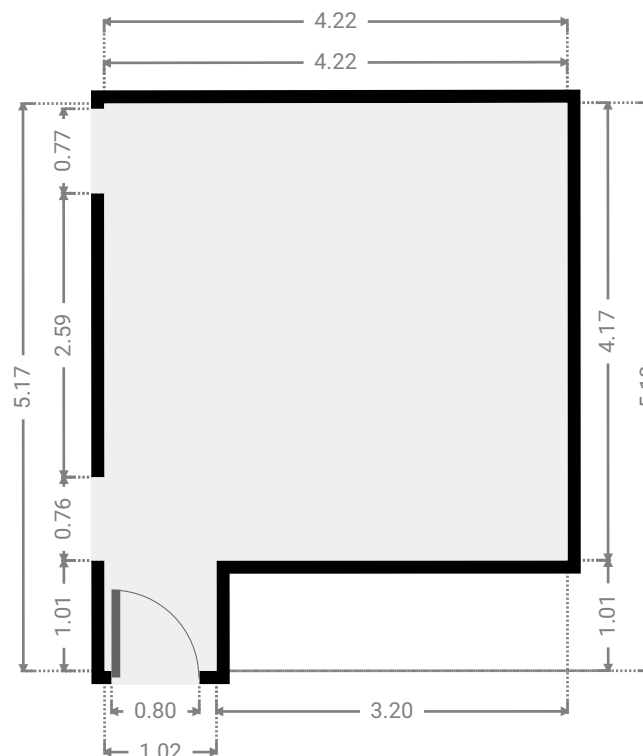

3 Quarrion

FLOORS: 1

▼ Study Ground Floor

WIDTH: 5.50 m • LENGTH: 4.67 m
AREA: 18.32 m² • PERIMETER: 20.34 m

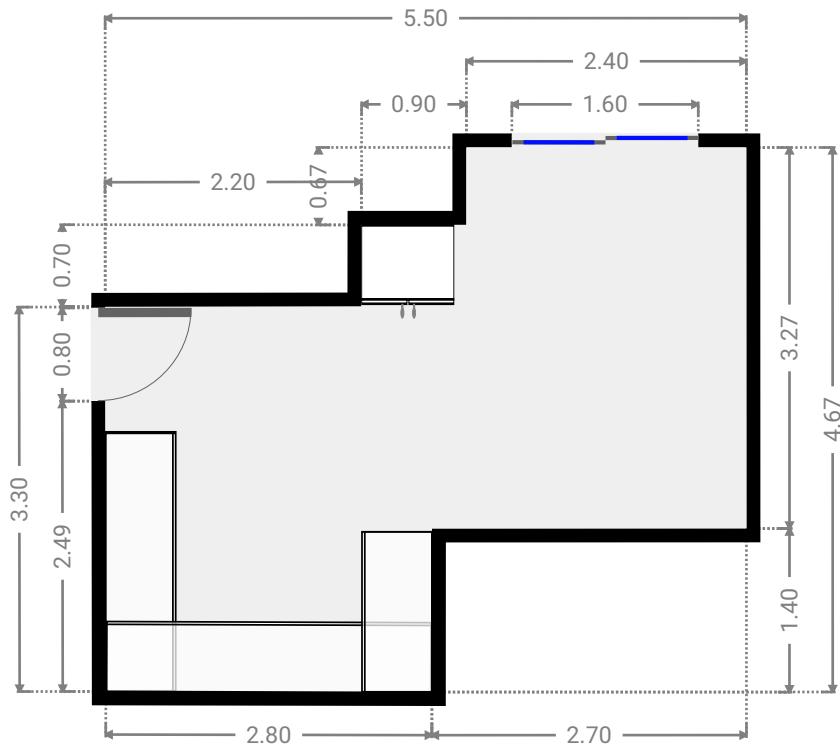

▼ Toilet Ground Floor

WIDTH: 0.99 m • LENGTH: 1.98 m
AREA: 1.97 m² • PERIMETER: 5.94 m

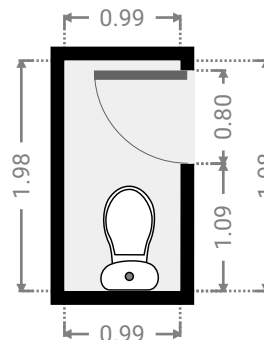

▼ Toilet Ground Floor

WIDTH: 1.20 m • LENGTH: 1.60 m
AREA: 1.92 m² • PERIMETER: 5.60 m

