

3 Matsen Court

SUBMITTED BY
Ray White Rockhampton

CREATED ON
2022-11-09

Floors
1

3 Matesen Court

FLOORS: 1



▼ Ground Floor

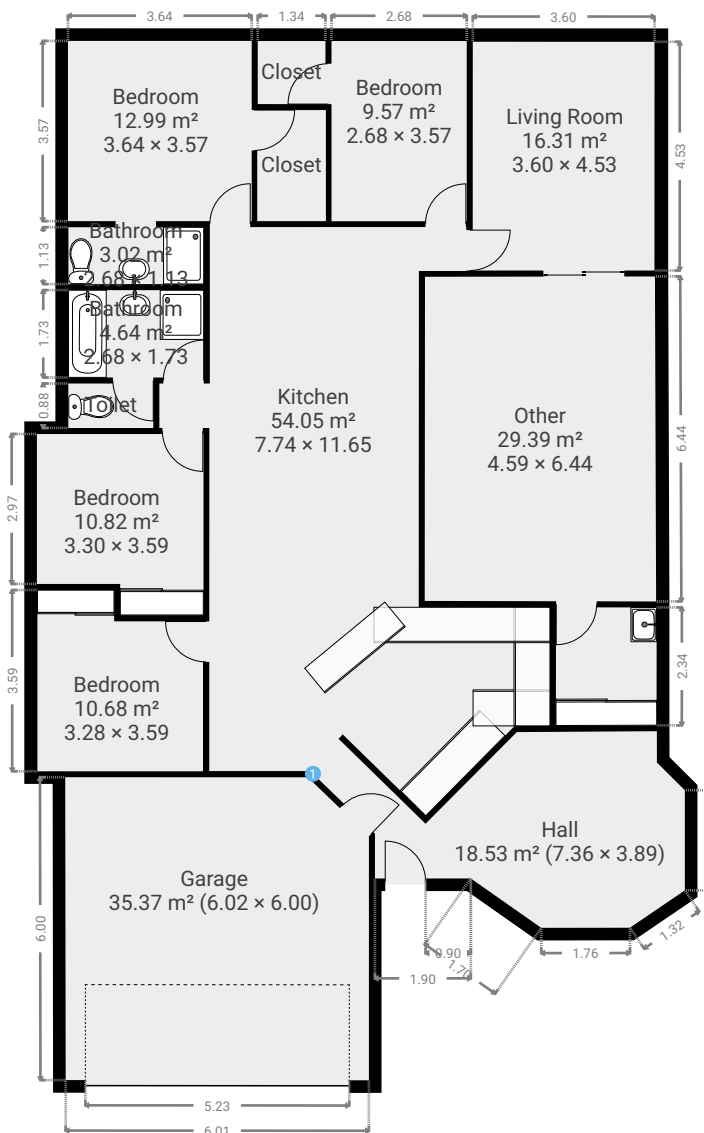
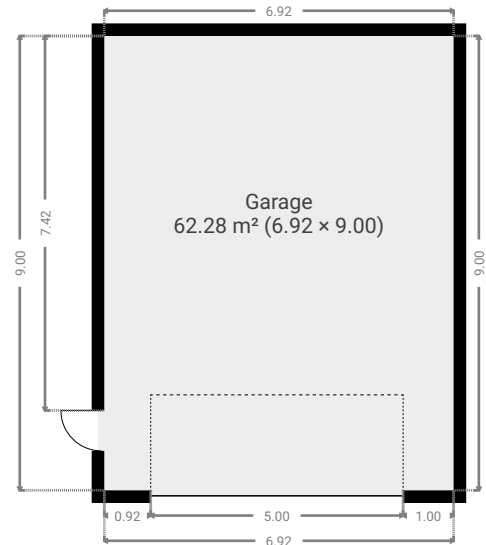

THIS FLOORPLAN IS PROVIDED WITHOUT WARRANTY OF ANY KIND. SENSOPIA DISCLAIMS ANY WARRANTY INCLUDING, WITHOUT LIMITATION, SATISFACTORY QUALITY OR ACCURACY OF DIMENSIONS.

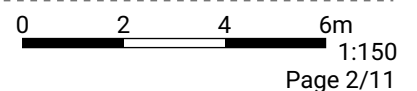

▼ Bathroom Ground Floor

WIDTH: 2.68 m • LENGTH: 1.73 m
AREA: 4.64 m² • PERIMETER: 8.82 m

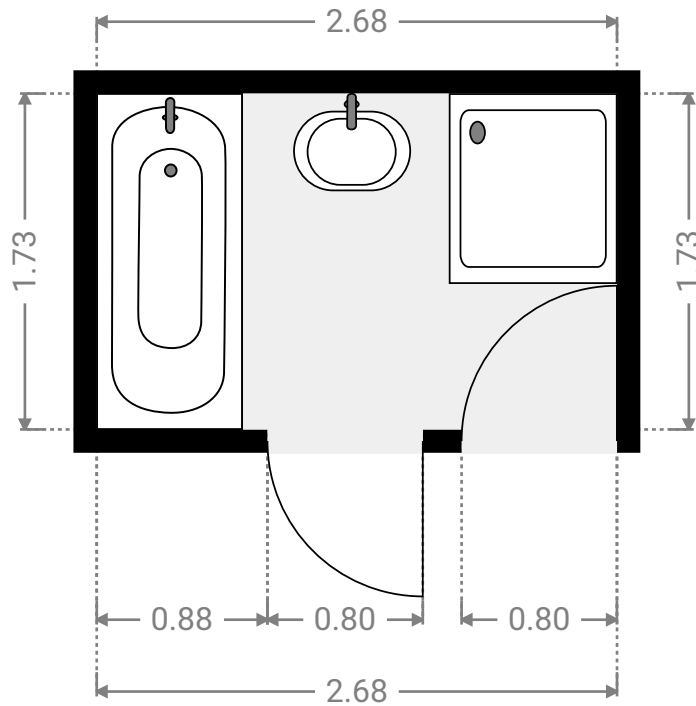
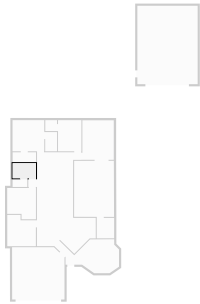

▼ Bathroom Ground Floor

WIDTH: 2.68 m • LENGTH: 1.13 m
AREA: 3.02 m² • PERIMETER: 7.62 m

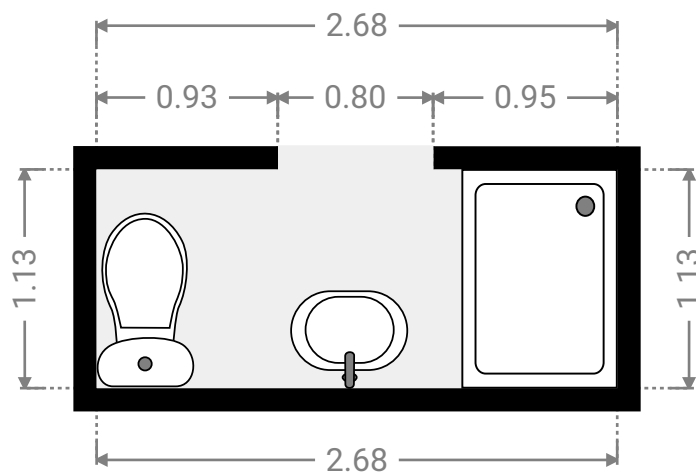
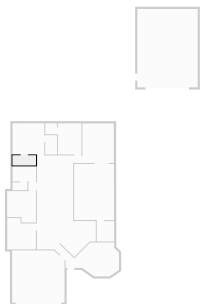

3 Matesen Court

FLOORS: 1



▼ Bedroom Ground Floor

WIDTH: 3.28 m • LENGTH: 3.59 m
AREA: 10.68 m² • PERIMETER: 13.74 m

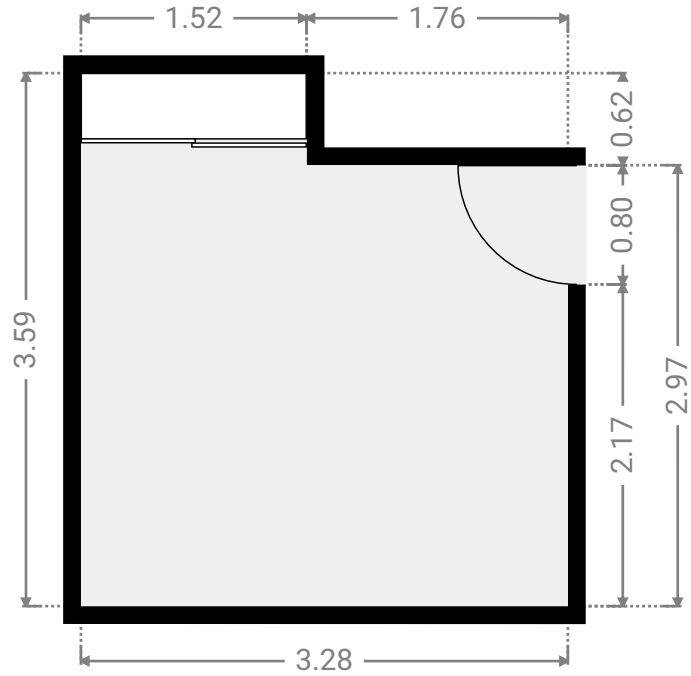
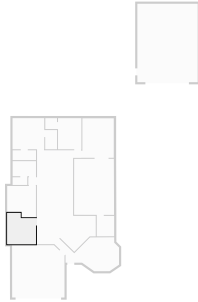

▼ Bedroom Ground Floor

WIDTH: 3.30 m • LENGTH: 3.59 m
AREA: 10.82 m² • PERIMETER: 13.78 m

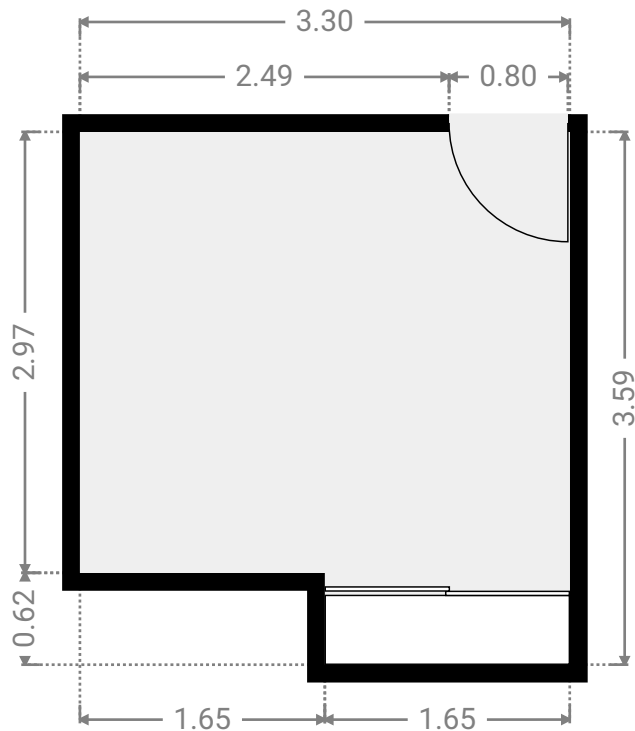
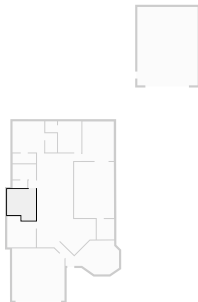

FLOORS: 1

▼ Bedroom Ground Floor

WIDTH: 3.64 m • LENGTH: 3.57 m
AREA: 12.99 m² • PERIMETER: 14.42 m

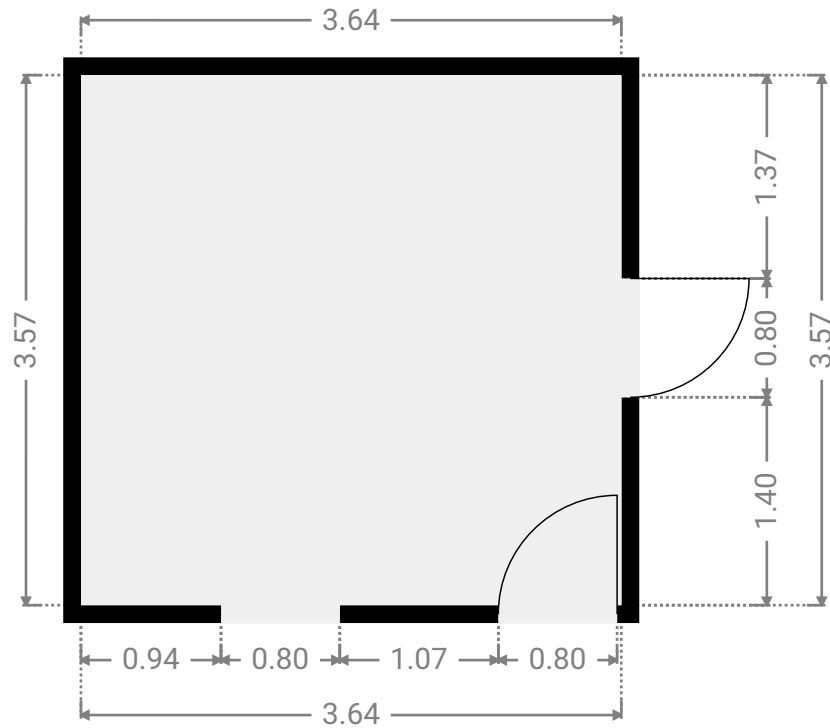

▼ Closet Ground Floor

WIDTH: 1.36 m • LENGTH: 2.20 m
AREA: 2.99 m² • PERIMETER: 7.12 m

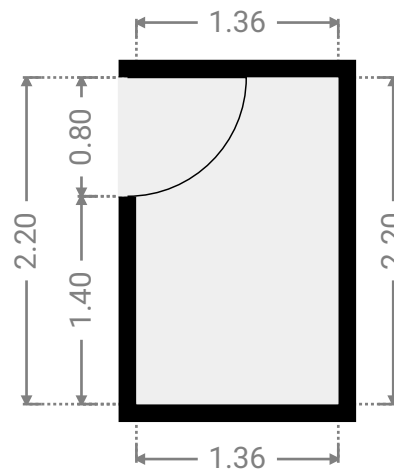
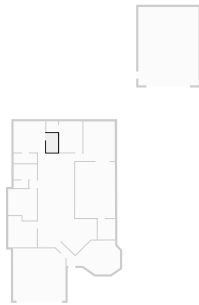

▼ Bedroom Ground Floor

WIDTH: 2.68 m • LENGTH: 3.57 m
AREA: 9.57 m² • PERIMETER: 12.50 m

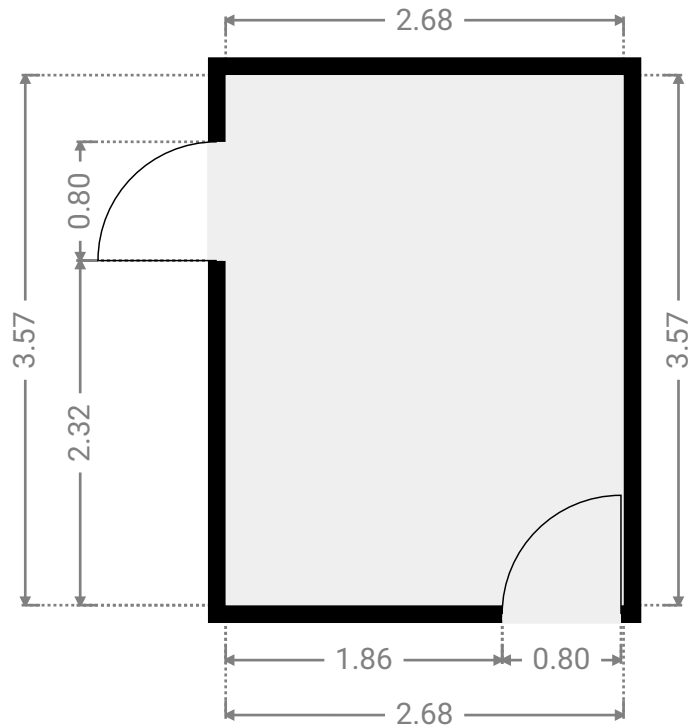
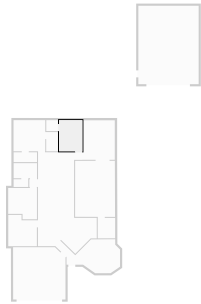

▼ Closet Ground Floor

WIDTH: 1.34 m • LENGTH: 1.25 m
AREA: 1.67 m² • PERIMETER: 5.18 m

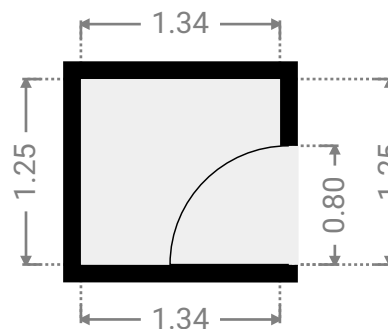
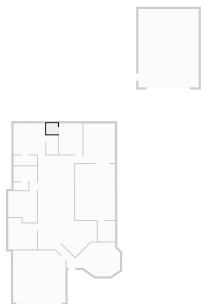

FLOORS: 1

▼ Garage Ground Floor

WIDTH: 6.02 m • LENGTH: 6.00 m
AREA: 35.37 m² • PERIMETER: 23.33 m

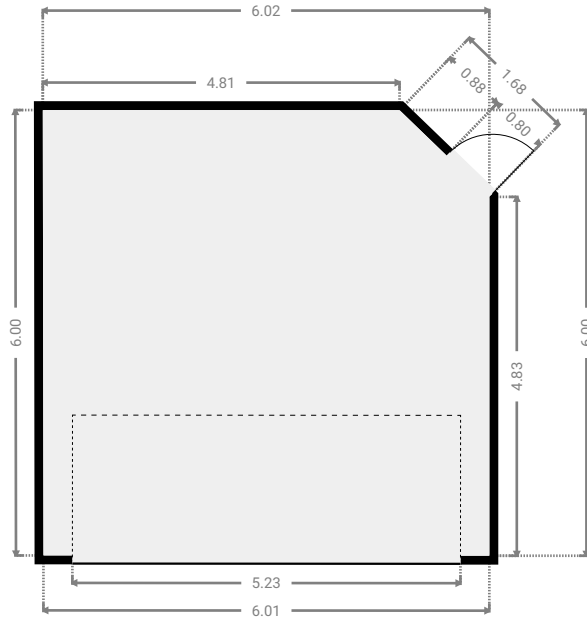
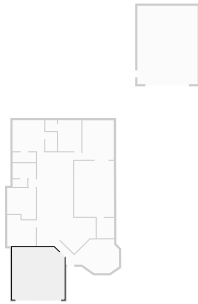

▼ Garage Ground Floor

WIDTH: 6.92 m • LENGTH: 9.00 m
AREA: 62.28 m² • PERIMETER: 31.84 m

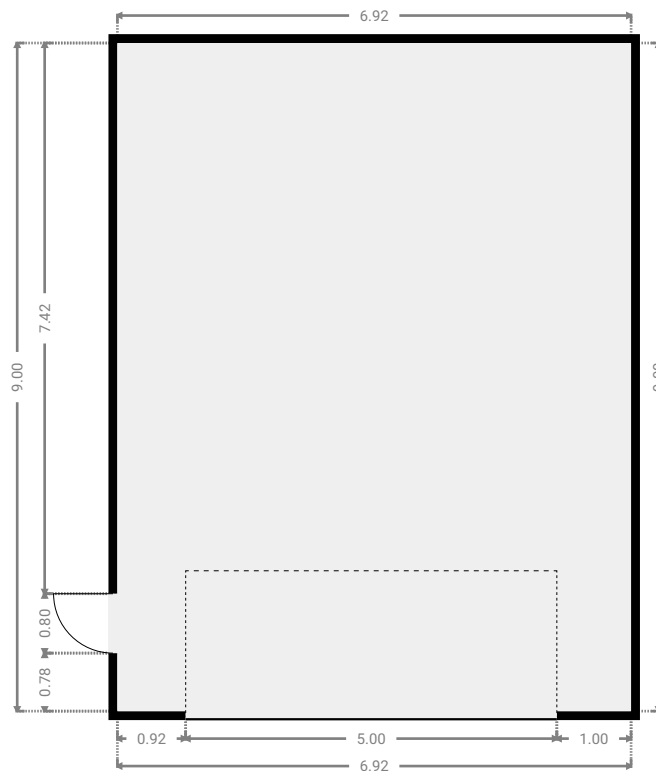
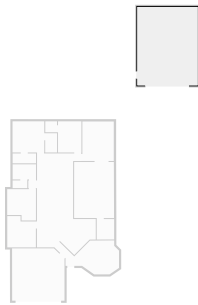

3 Matesen Court

FLOORS: 1

▼ Hall Ground Floor

WIDTH: 7.36 m • LENGTH: 3.89 m
AREA: 18.53 m² • PERIMETER: 21.13 m

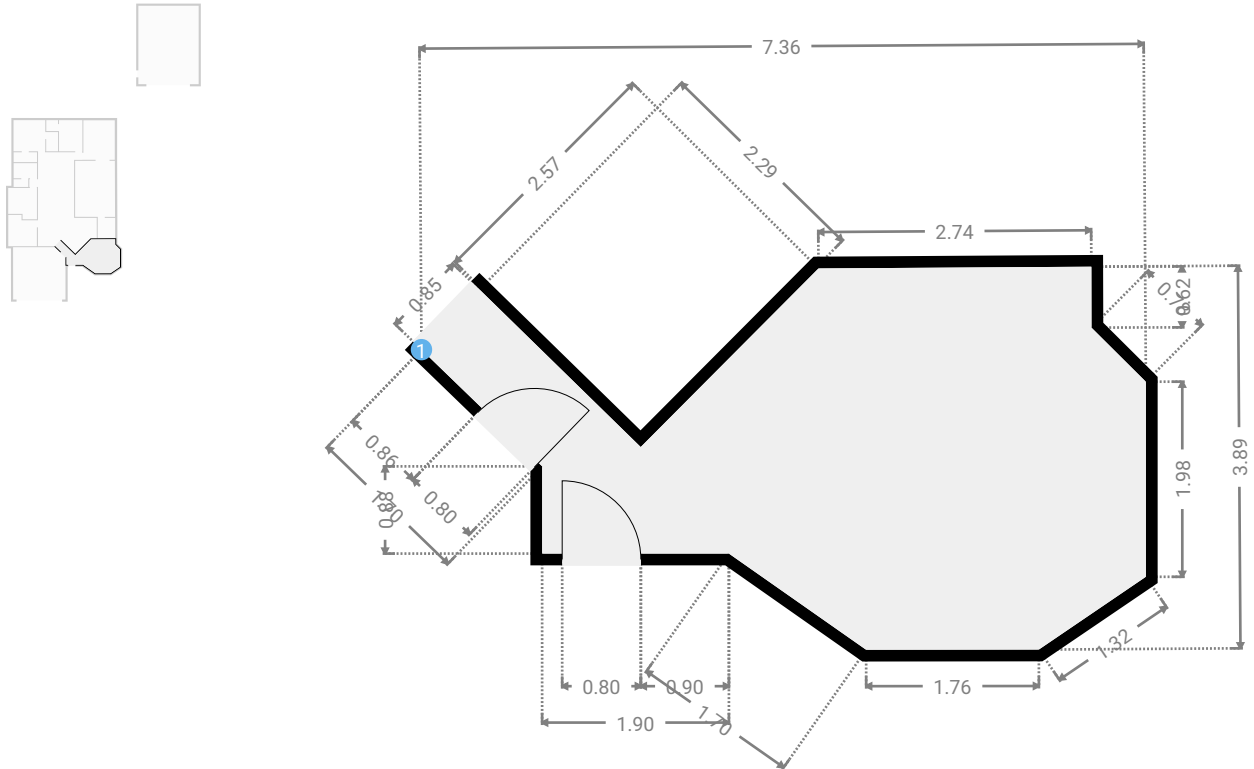

▼ Hall/Ground Floor

1 OPENING

Height
0.00 m



3 Matesen Court

FLOORS: 1



▼ Living Room Ground Floor

WIDTH: 3.60 m • LENGTH: 4.53 m
AREA: 16.31 m² • PERIMETER: 16.26 m

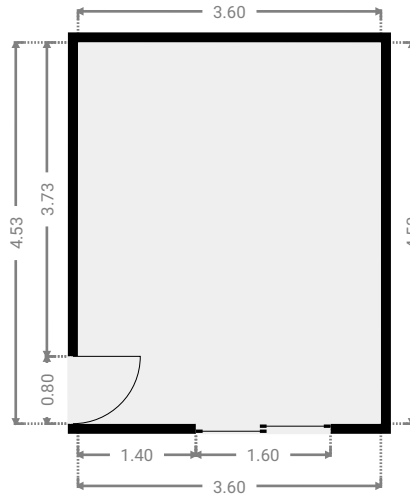
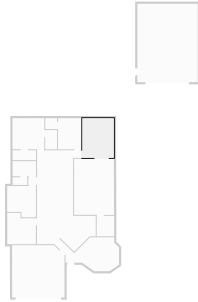

▼ Other Ground Floor

WIDTH: 4.59 m • LENGTH: 6.44 m
AREA: 29.39 m² • PERIMETER: 22.00 m

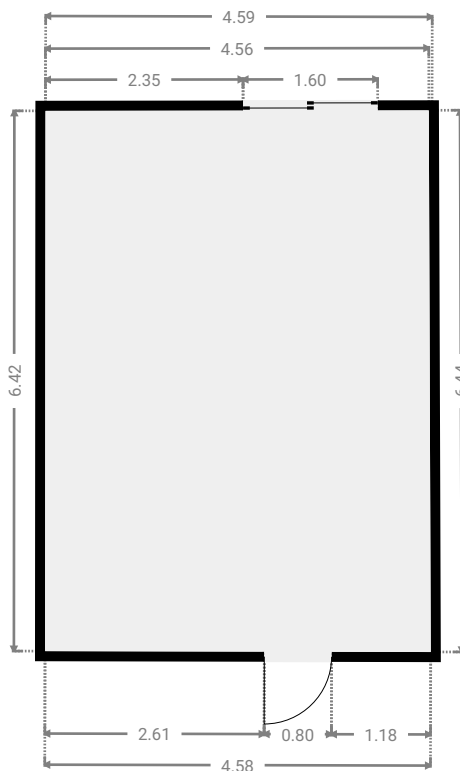
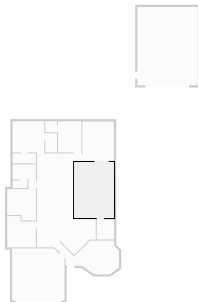

THIS FLOORPLAN IS PROVIDED WITHOUT WARRANTY OF ANY KIND. SENSOPIA DISCLAIMS ANY WARRANTY INCLUDING, WITHOUT LIMITATION, SATISFACTORY QUALITY OR ACCURACY OF DIMENSIONS.

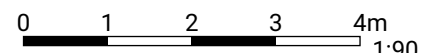

▼ Toilet Ground Floor

WIDTH: 1.68 m • LENGTH: 0.88 m
AREA: 1.48 m² • PERIMETER: 5.12 m

