

# 3 Mahogany Street

## Ground Floor

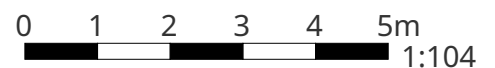

THIS FLOORPLAN IS PROVIDED WITHOUT WARRANTY OF ANY KIND. SENSOPIA DISCLAIMS ANY WARRANTY INCLUDING, WITHOUT LIMITATION, SATISFACTORY QUALITY OR ACCURACY OF DIMENSIONS.



# 3 Mahogany Street

## Living Area

Width: 4.62 m  
 Length: 5.33 m  
 Area: 22.64 m<sup>2</sup>  
 Perimeter: 19.90 m

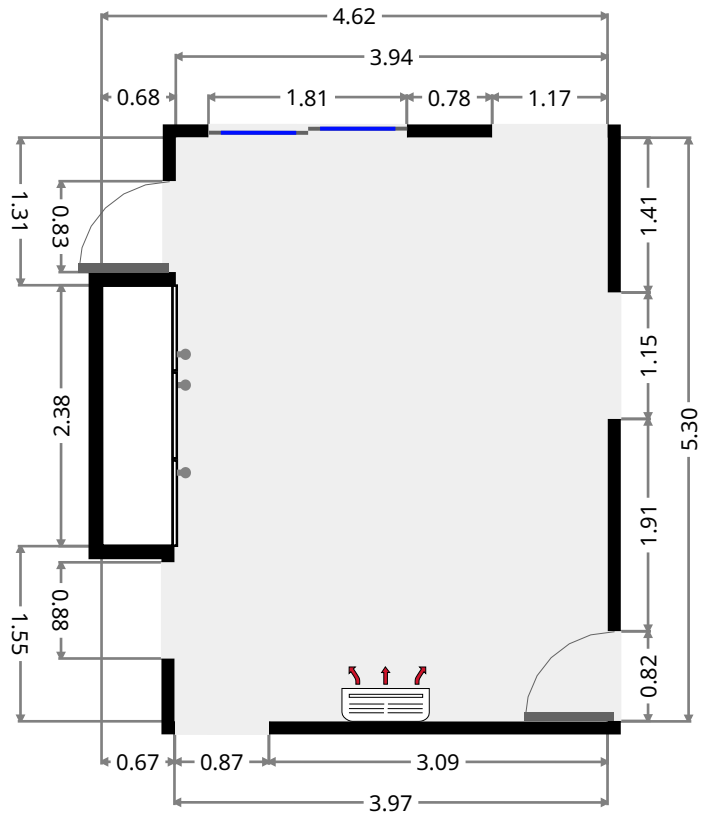
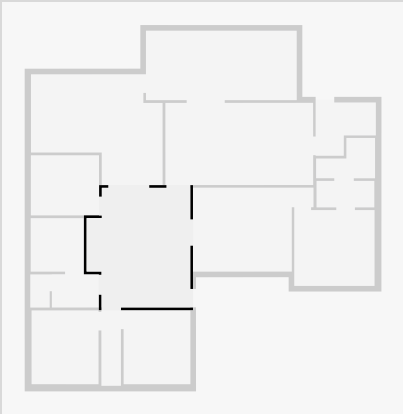

## Hall

Width: 0.87 m  
 Length: 3.41 m  
 Area: 2.96 m<sup>2</sup>  
 Perimeter: 8.54 m

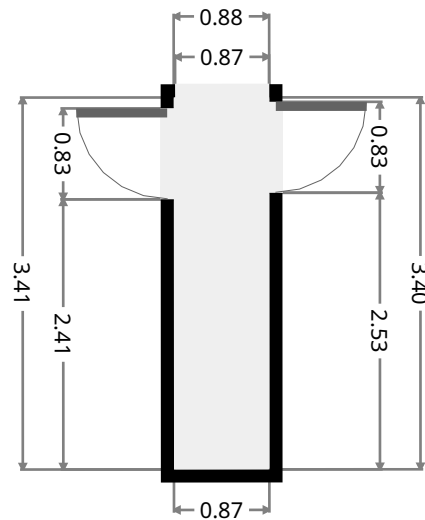
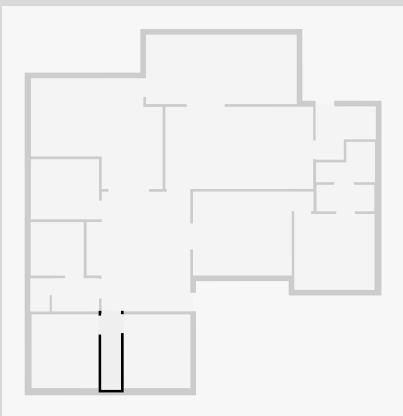

# 3 Mahogany Street

## Bedroom

Width: 2.98 m  
 Length: 3.28 m  
 Area: 9.82 m<sup>2</sup>  
 Perimeter: 12.55 m

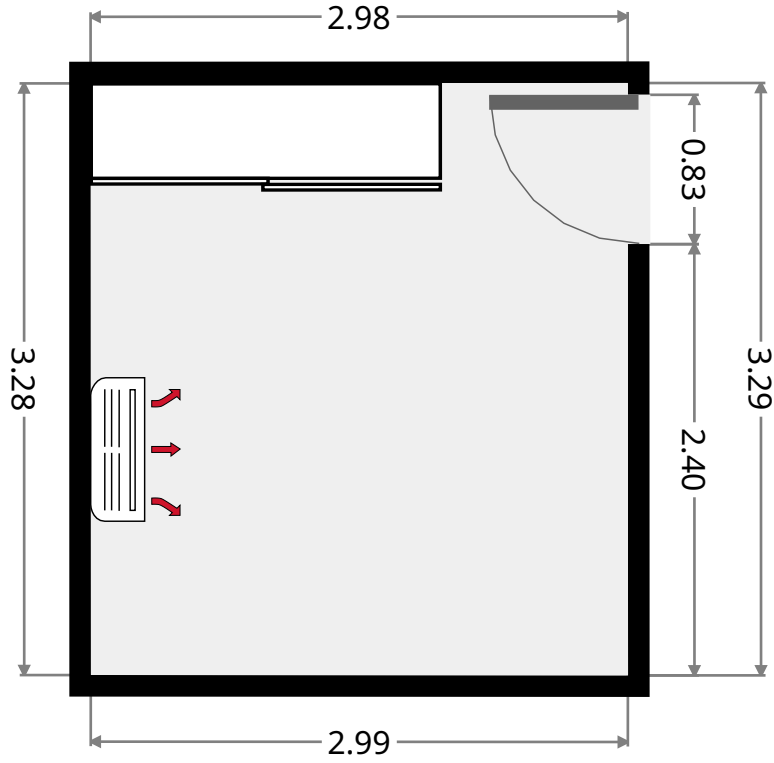
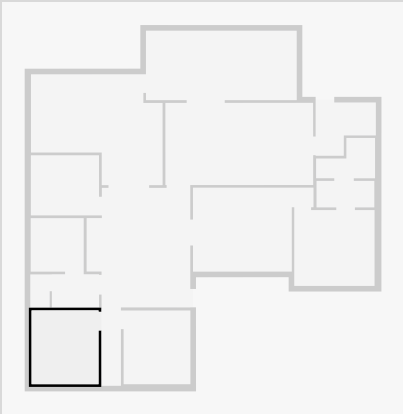

## Bedroom

Width: 2.98 m  
 Length: 3.28 m  
 Area: 9.78 m<sup>2</sup>  
 Perimeter: 12.52 m

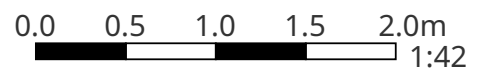
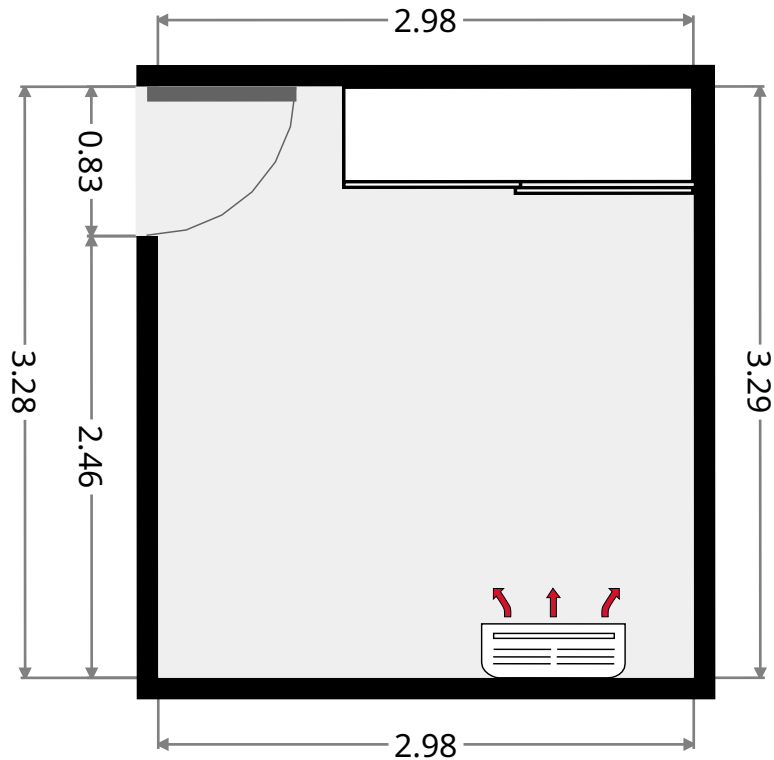
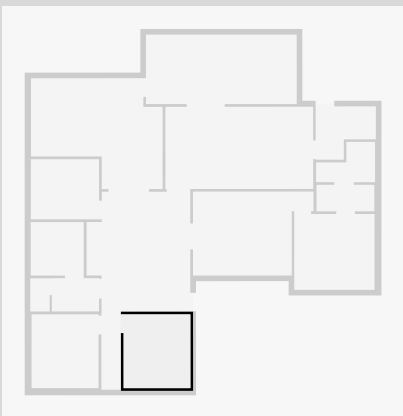

THIS FLOORPLAN IS PROVIDED WITHOUT WARRANTY OF ANY KIND. SENSOPIA DISCLAIMS ANY WARRANTY INCLUDING, WITHOUT LIMITATION, SATISFACTORY QUALITY OR ACCURACY OF DIMENSIONS.

# 3 Mahogany Street

## Hall

Width: 1.49 m  
 Length: 2.10 m  
 Area: 3.12 m<sup>2</sup>  
 Perimeter: 7.17 m

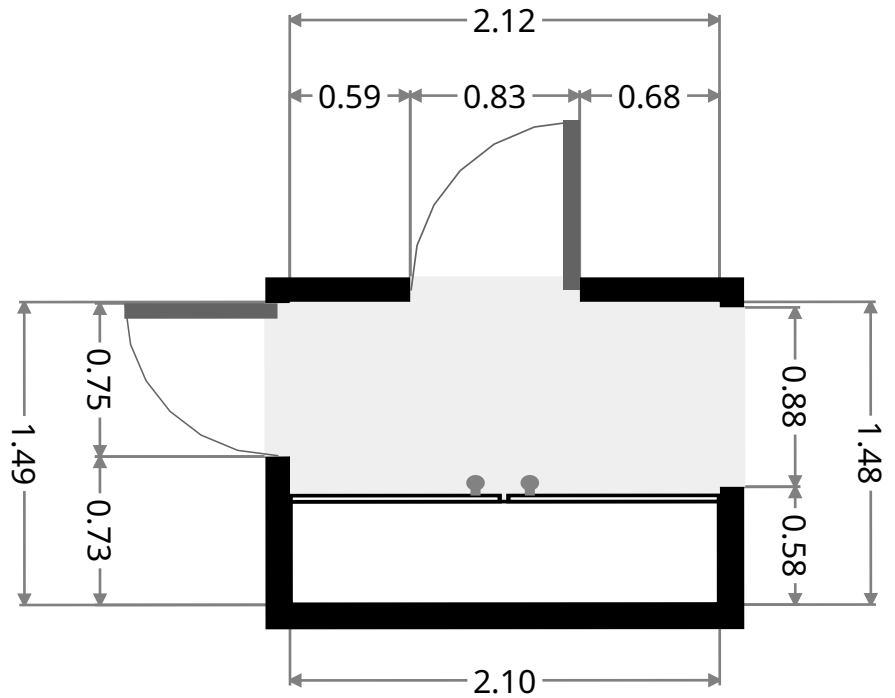
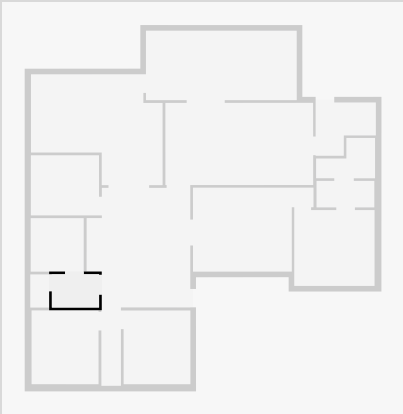

## Toilet

Width: 0.86 m  
 Length: 1.48 m  
 Area: 1.28 m<sup>2</sup>  
 Perimeter: 4.69 m

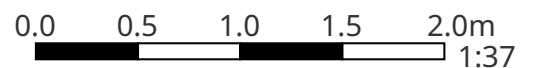
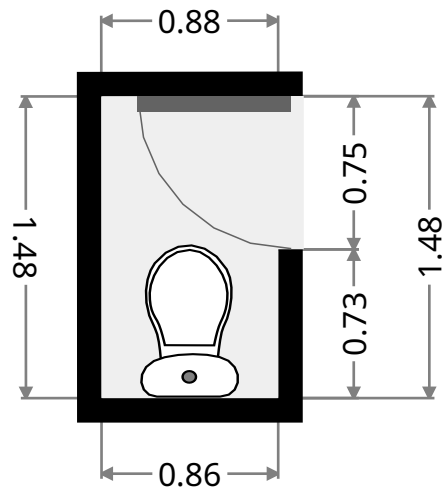
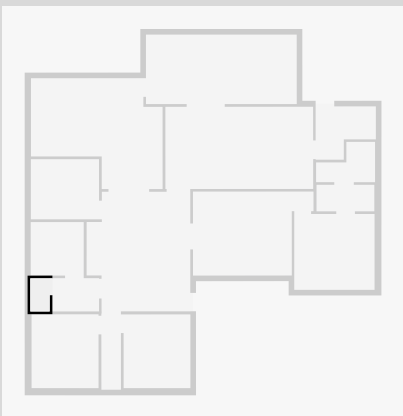

# 3 Mahogany Street

## Bathroom

Width: 2.36 m  
Length: 2.38 m  
Area: 5.63 m<sup>2</sup>  
Perimeter: 9.49 m

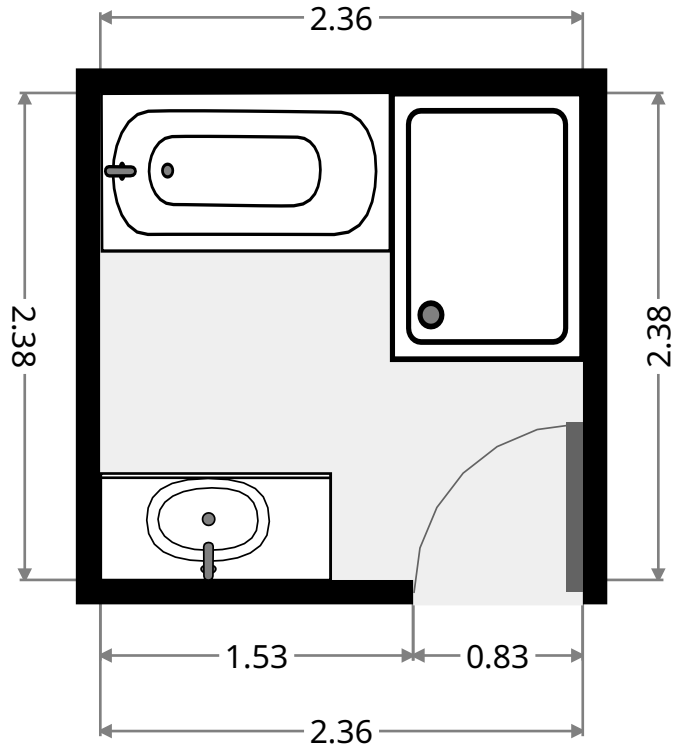
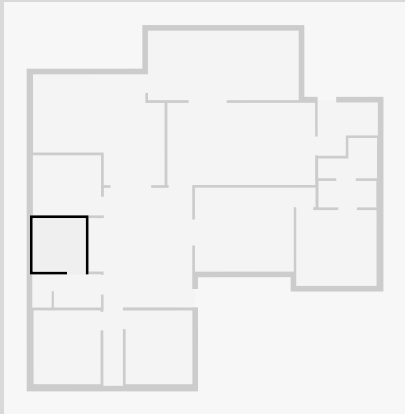

## Bedroom

Width: 2.68 m  
Length: 3.04 m  
Area: 8.14 m<sup>2</sup>  
Perimeter: 11.44 m

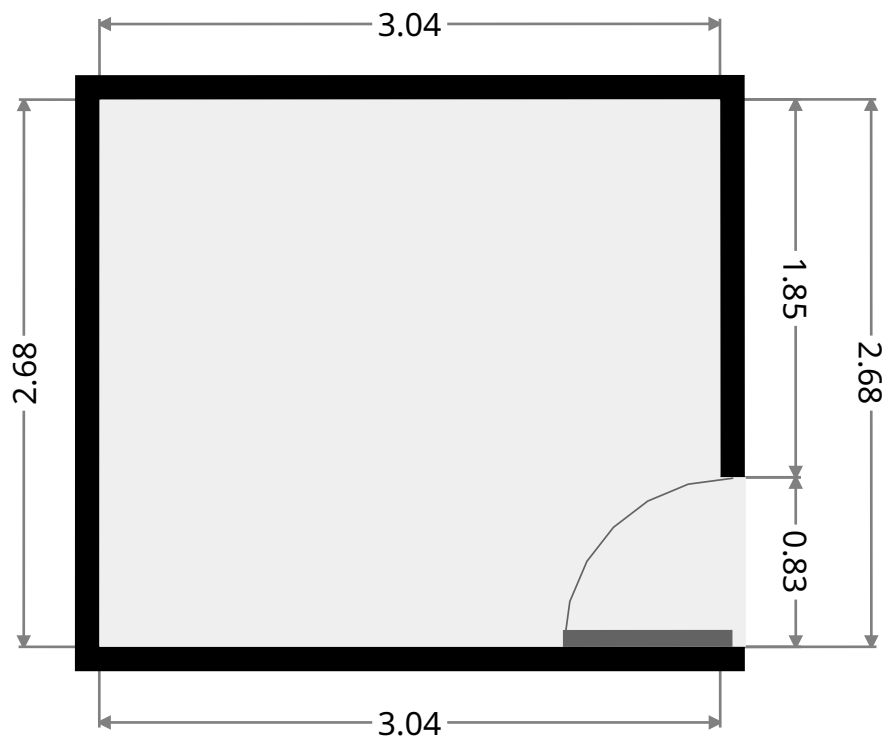
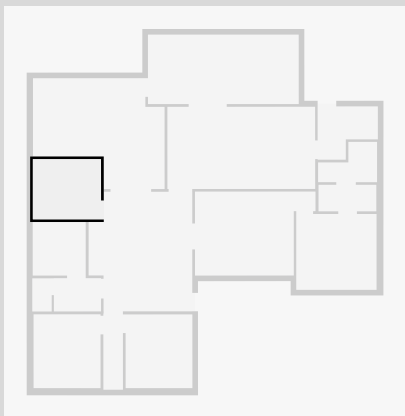

# 3 Mahogany Street

## Living Room

Width: 3.75 m  
 Length: 5.38 m  
 Area: 17.33 m<sup>2</sup>  
 Perimeter: 18.23 m

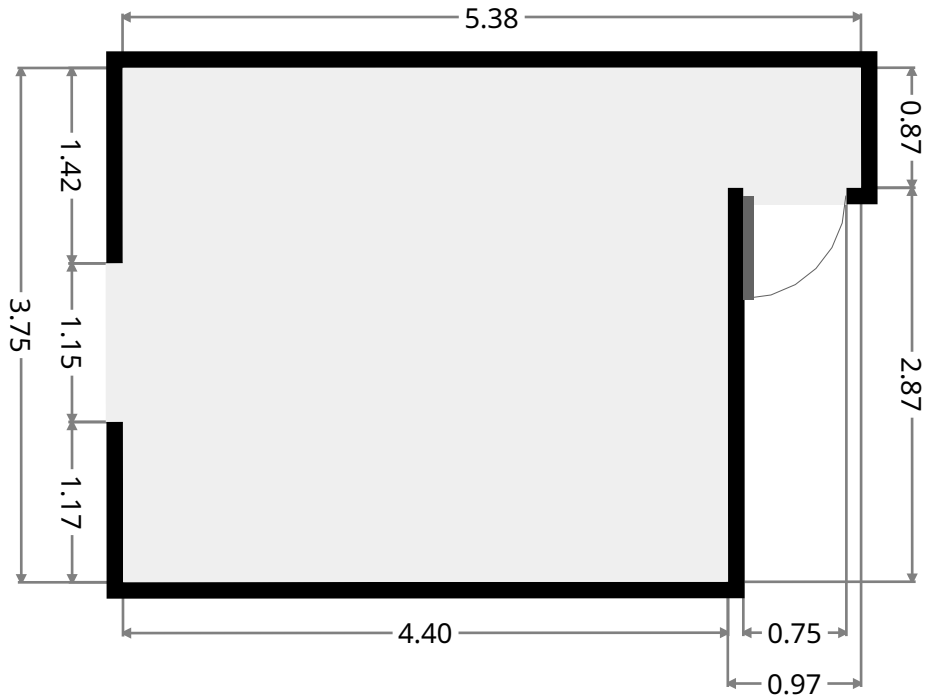
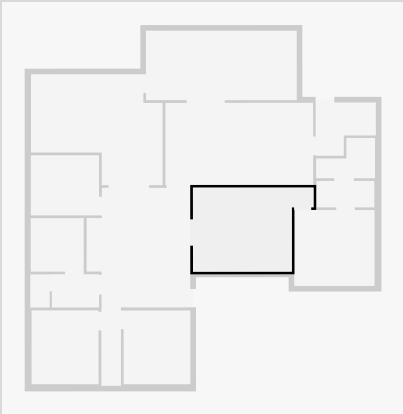

## Master Bedroom

Width: 3.38 m  
 Length: 3.58 m  
 Area: 12.09 m<sup>2</sup>  
 Perimeter: 13.92 m

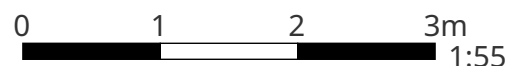
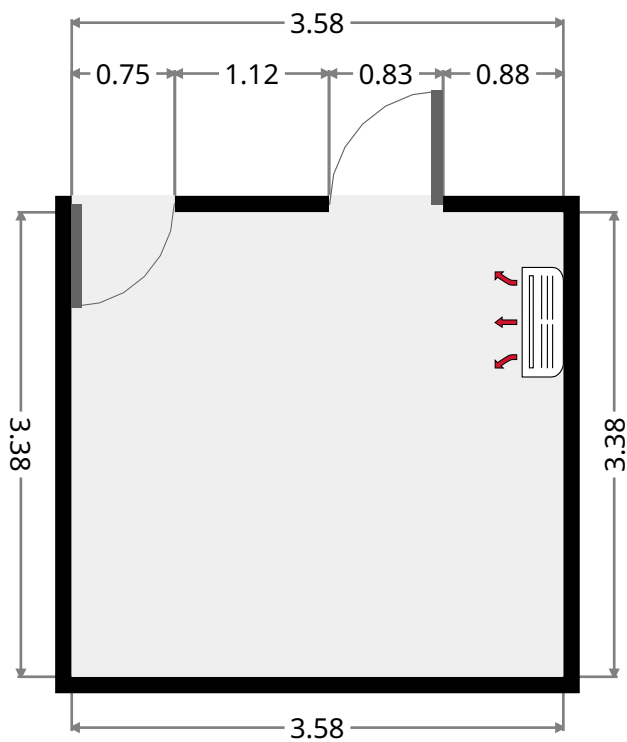
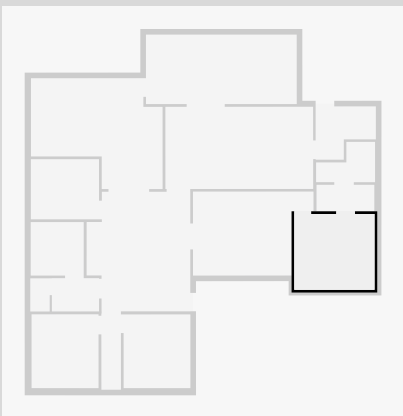

# 3 Mahogany Street

## WIR

Width: 1.19 m  
 Length: 2.58 m  
 Area: 3.04 m<sup>2</sup>  
 Perimeter: 7.52 m

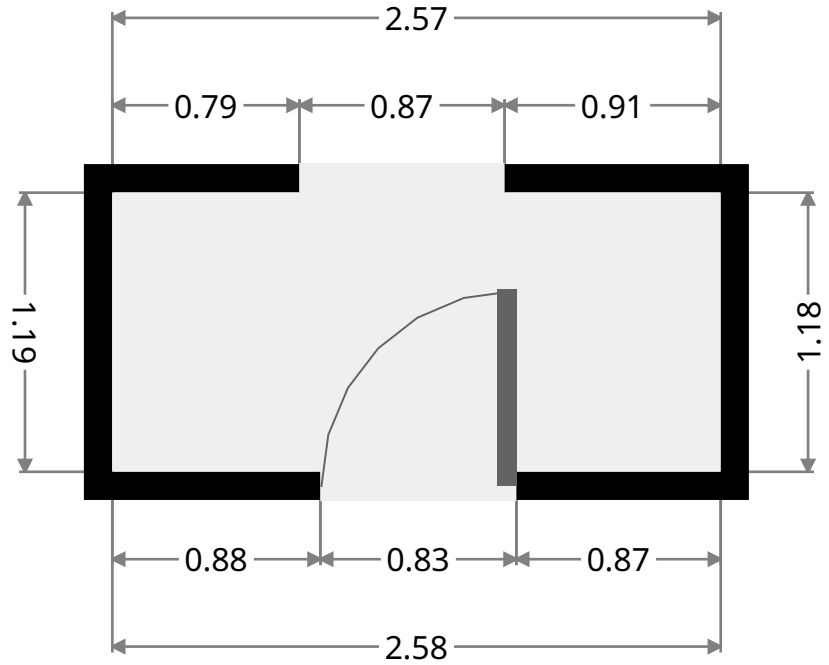
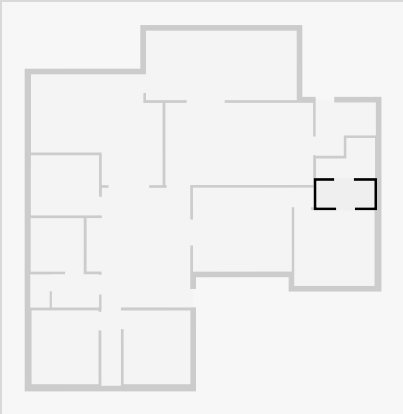

## Ensuite

Width: 1.80 m  
 Length: 2.63 m  
 Area: 3.49 m<sup>2</sup>  
 Perimeter: 8.85 m

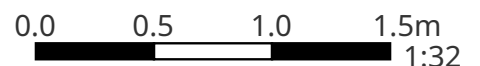
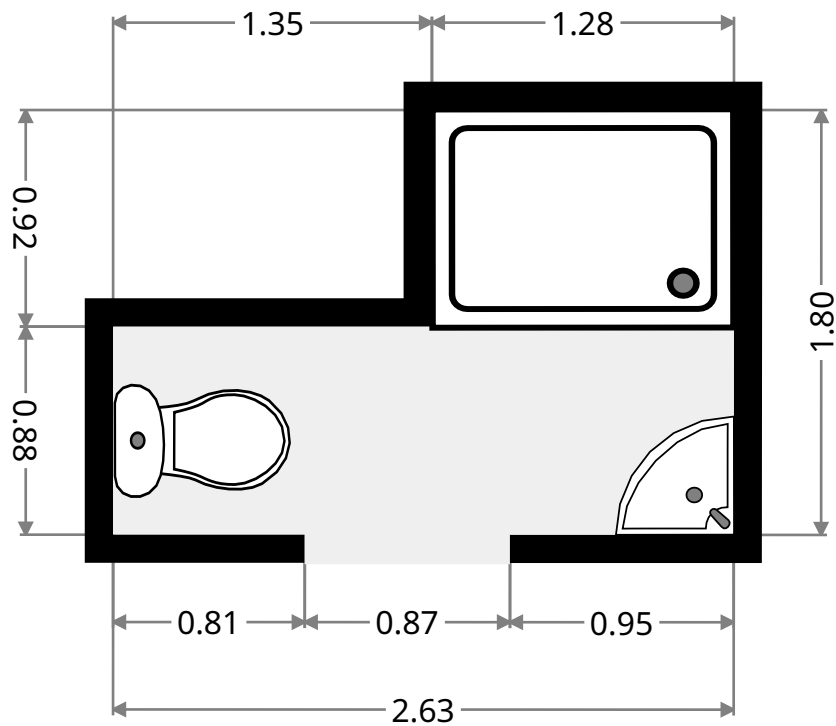
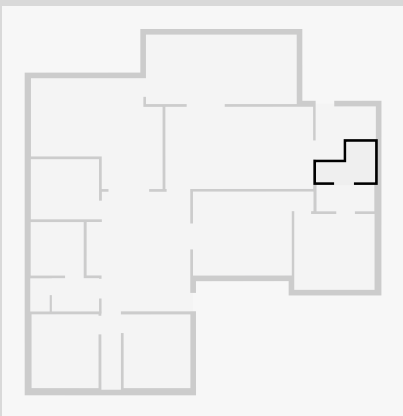

THIS FLOORPLAN IS PROVIDED WITHOUT WARRANTY OF ANY KIND. SENSOPIA DISCLAIMS ANY WARRANTY INCLUDING, WITHOUT LIMITATION, SATISFACTORY QUALITY OR ACCURACY OF DIMENSIONS.

# 3 Mahogany Street

## Kitchen/Dining

Width: 3.66 m  
 Length: 6.59 m  
 Area: 24.13 m<sup>2</sup>  
 Perimeter: 20.50 m

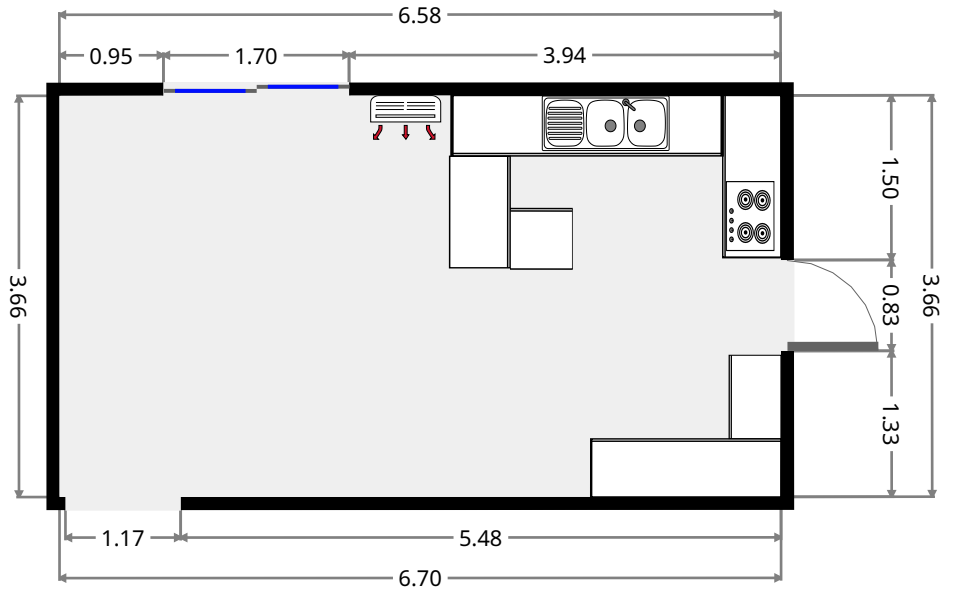
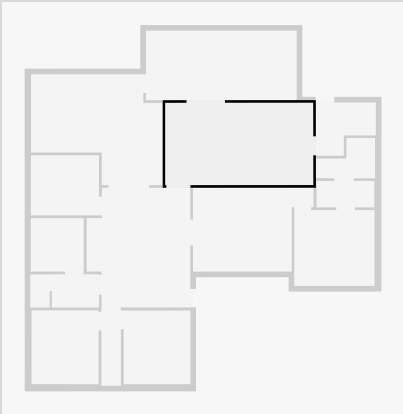

## Laundry Room

Width: 2.38 m  
 Length: 2.69 m  
 Area: 5.08 m<sup>2</sup>  
 Perimeter: 10.12 m

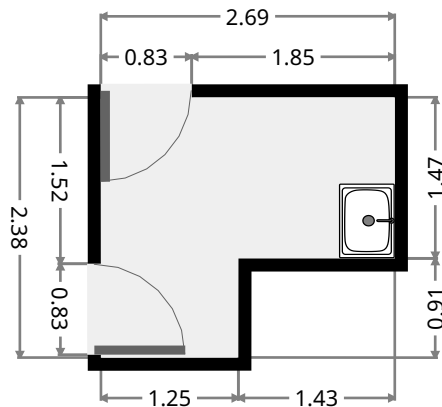
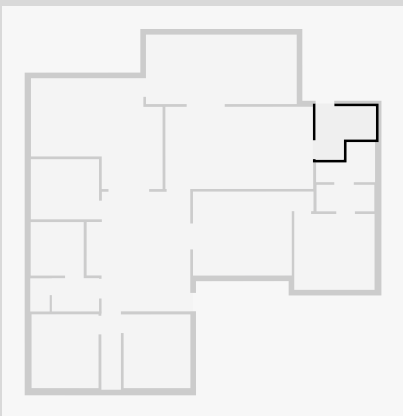

THIS FLOORPLAN IS PROVIDED WITHOUT WARRANTY OF ANY KIND. SENSOPIA DISCLAIMS ANY WARRANTY INCLUDING, WITHOUT LIMITATION, SATISFACTORY QUALITY OR ACCURACY OF DIMENSIONS.





# 3 Mahogany Street

## Enclosed Patio

Width: 4.94 m  
 Length: 5.87 m  
 Area: 23.30 m<sup>2</sup>  
 Perimeter: 21.61 m

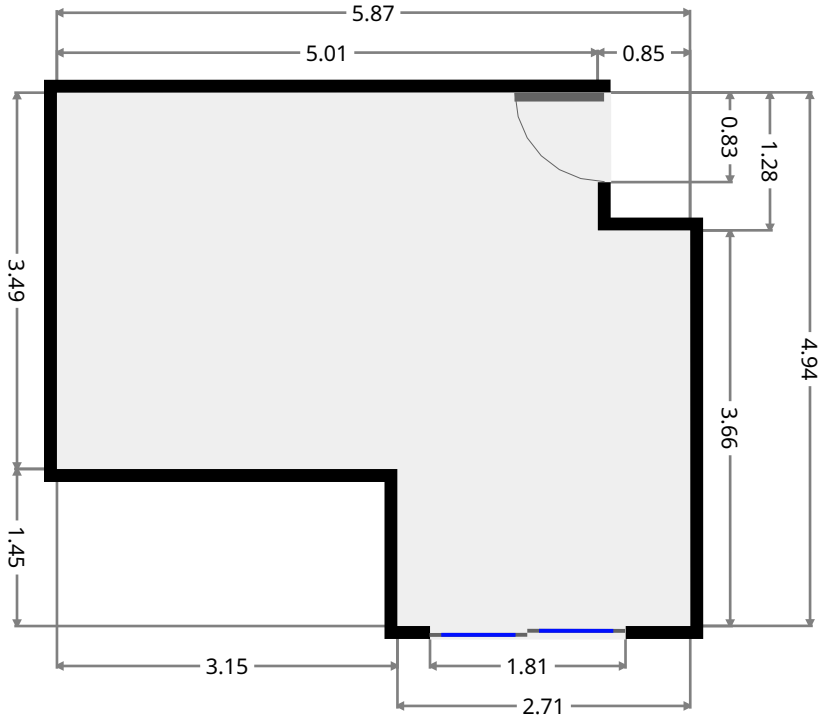
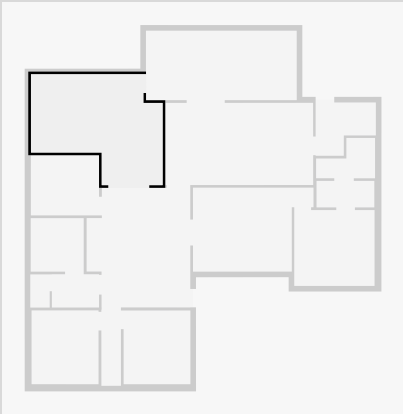

## Enclosed Patio

Width: 3.10 m  
 Length: 6.72 m  
 Area: 20.81 m<sup>2</sup>  
 Perimeter: 19.64 m

