

3 Langford Street

Ground Floor

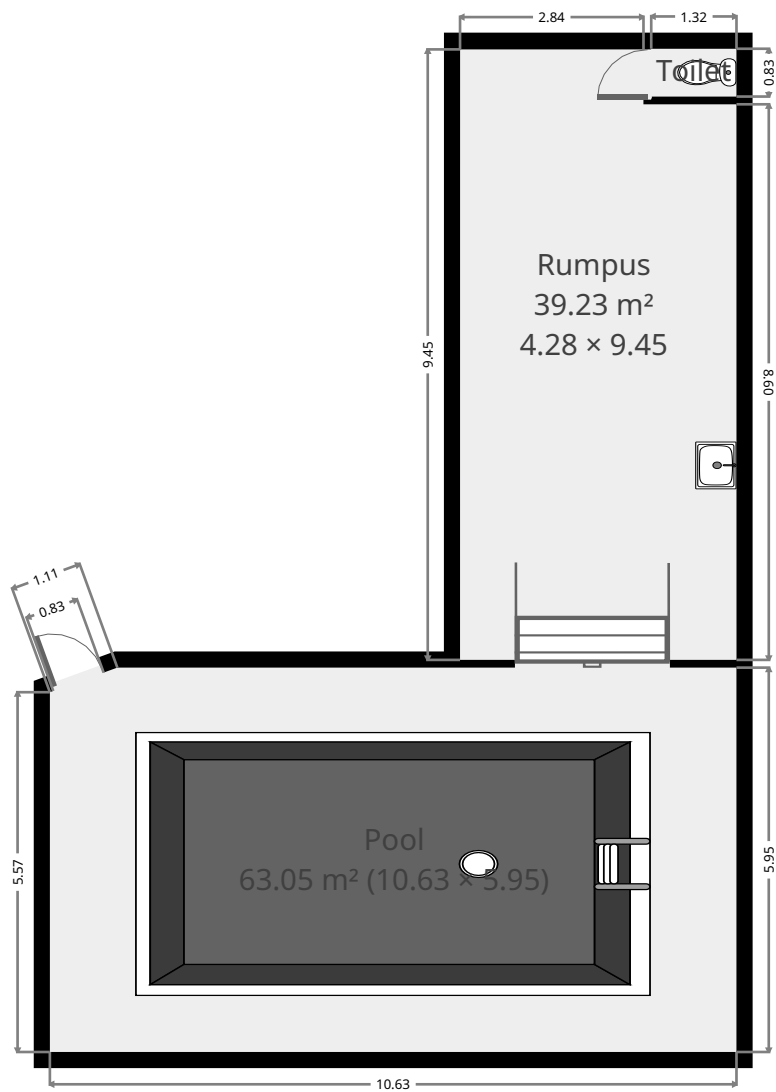

THIS FLOORPLAN IS PROVIDED WITHOUT WARRANTY OF ANY KIND. SENSOPIA DISCLAIMS ANY WARRANTY INCLUDING, WITHOUT LIMITATION, SATISFACTORY QUALITY OR ACCURACY OF DIMENSIONS.



3 Langford Street

Rumpus

Width: 4.28 m
Length: 9.45 m
Area: 39.23 m²
Perimeter: 27.46 m

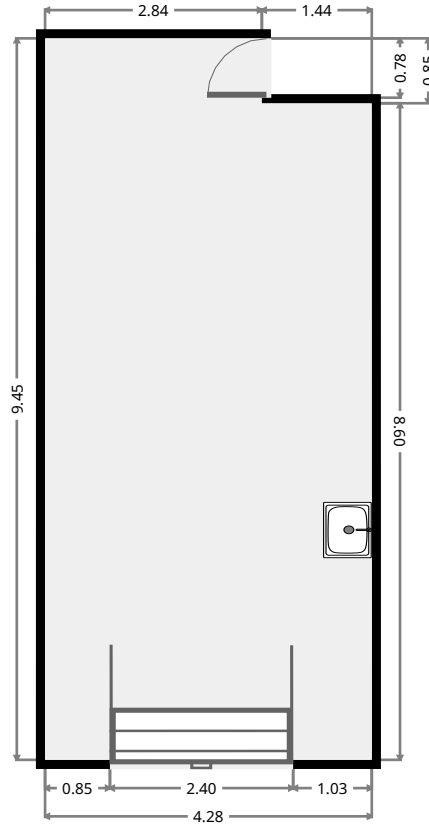
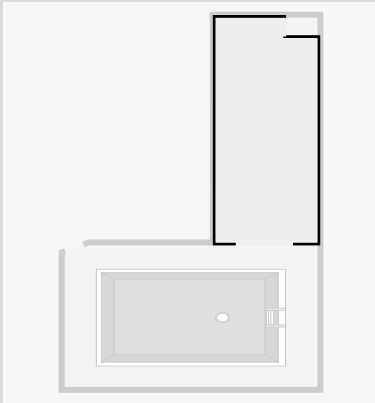

Toilet

Width: 0.74 m
Length: 1.32 m
Area: 0.98 m²
Perimeter: 4.12 m

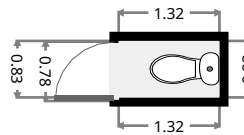
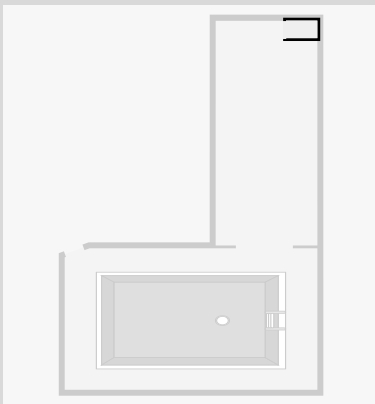

3 Langford Street

Pool

Width: 5.95 m
Length: 10.63 m
Area: 63.05 m²
Perimeter: 32.85 m

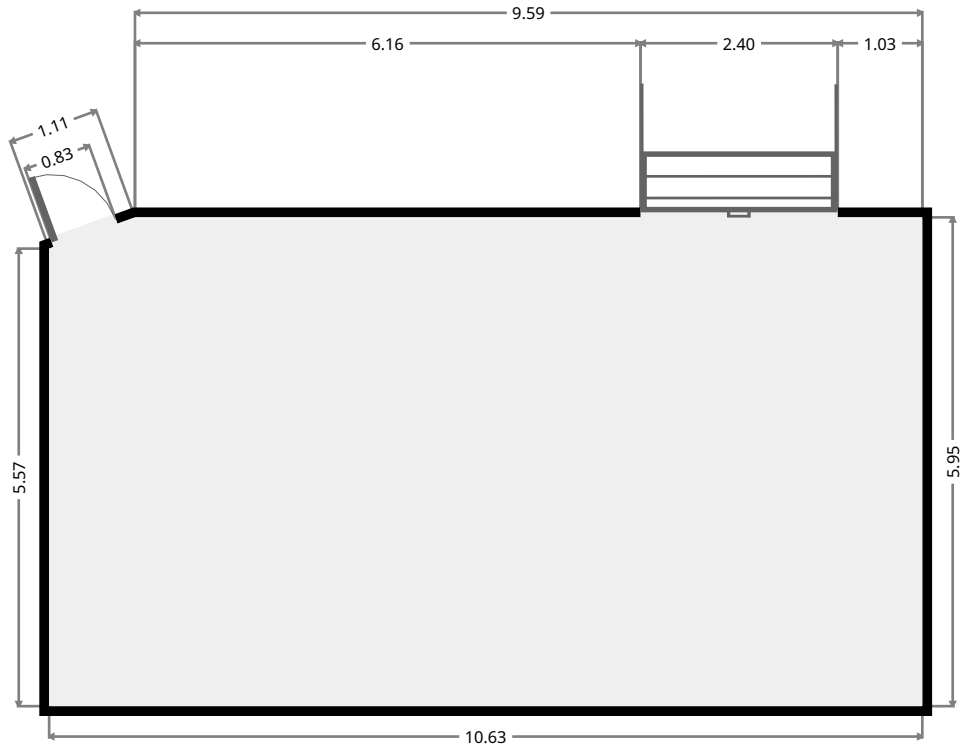
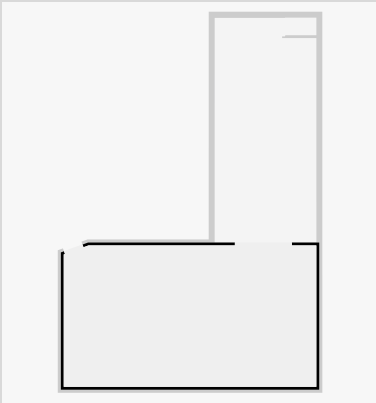

3 Langford Street

1st Floor



THIS FLOORPLAN IS PROVIDED WITHOUT WARRANTY OF ANY KIND. SENSOPIA DISCLAIMS ANY WARRANTY INCLUDING, WITHOUT LIMITATION, SATISFACTORY QUALITY OR ACCURACY OF DIMENSIONS.



3 Langford Street

Master Bedroom

Width: 3.58 m
Length: 4.12 m
Area: 14.70 m²
Perimeter: 15.38 m

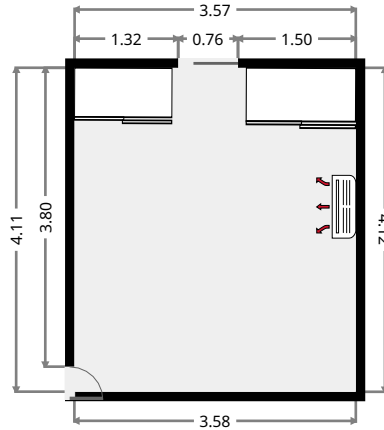
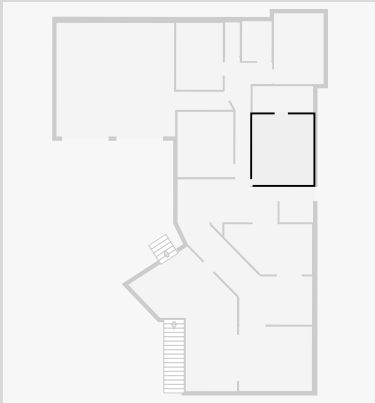

Front Verandah

Width: 4.51 m
Length: 5.51 m
Area: 29.51 m²
Perimeter: 25.28 m

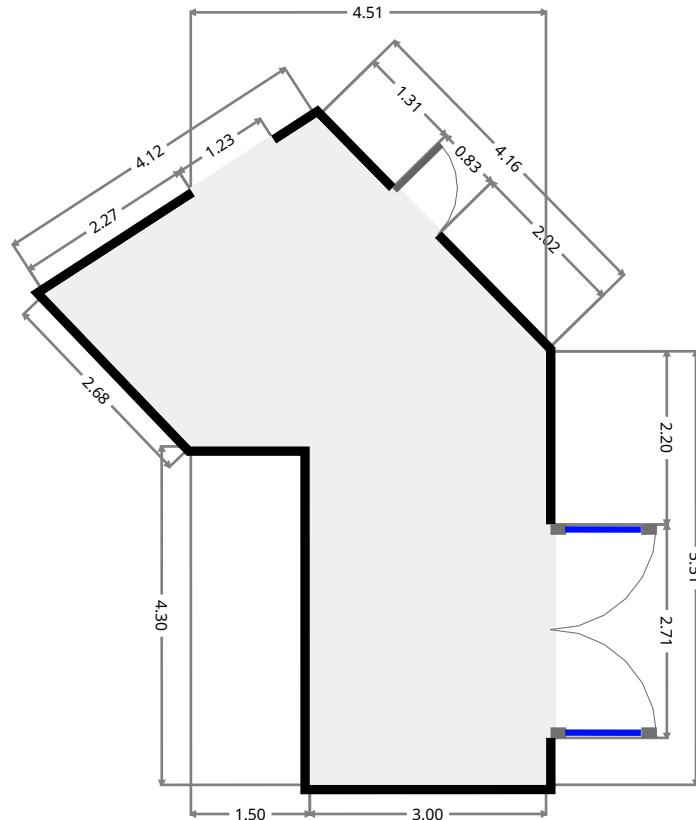
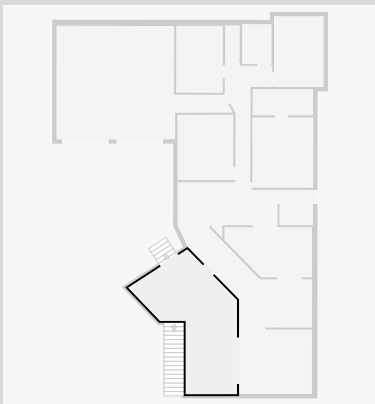

THIS FLOORPLAN IS PROVIDED WITHOUT WARRANTY OF ANY KIND. SENSOPIA DISCLAIMS ANY WARRANTY INCLUDING, WITHOUT LIMITATION, SATISFACTORY QUALITY OR ACCURACY OF DIMENSIONS.

3 Langford Street

Garage

Width: 6.67 m
Length: 10.35 m
Area: 49.30 m²
Perimeter: 33.56 m

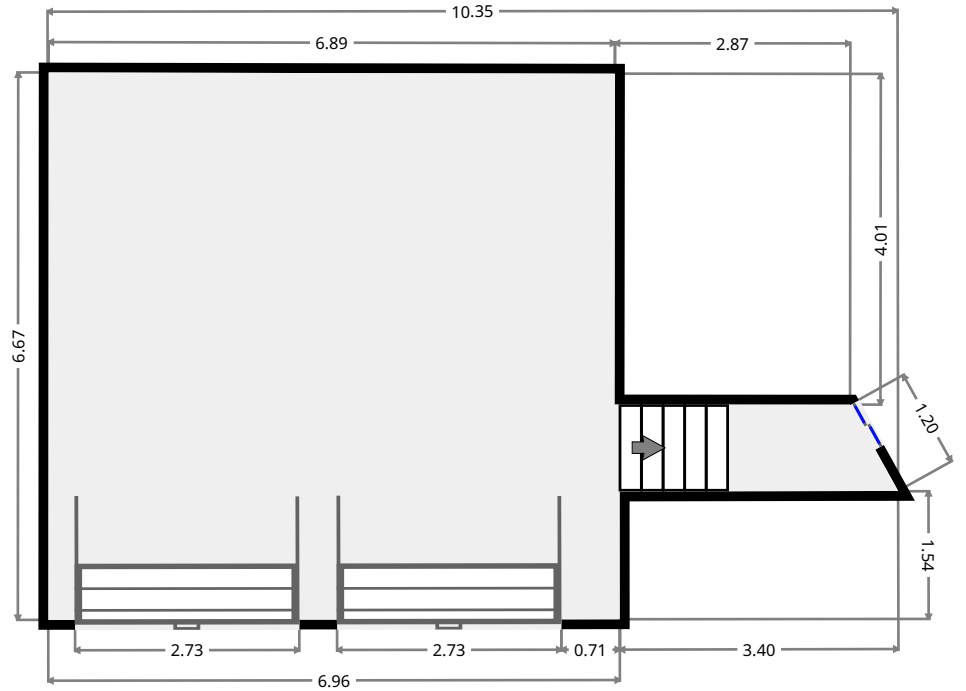
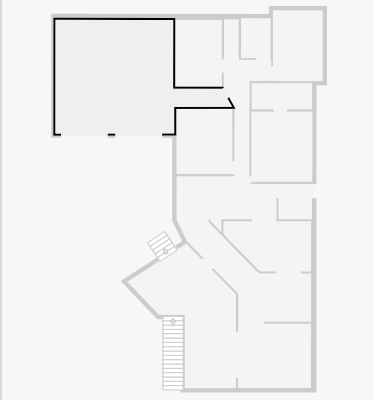

THIS FLOORPLAN IS PROVIDED WITHOUT WARRANTY OF ANY KIND. SENSOPIA DISCLAIMS ANY WARRANTY INCLUDING, WITHOUT LIMITATION, SATISFACTORY QUALITY OR ACCURACY OF DIMENSIONS.



3 Langford Street

Outdoor Area

Width: 2.91 m
Length: 4.15 m
Area: 12.08 m²
Perimeter: 14.12 m

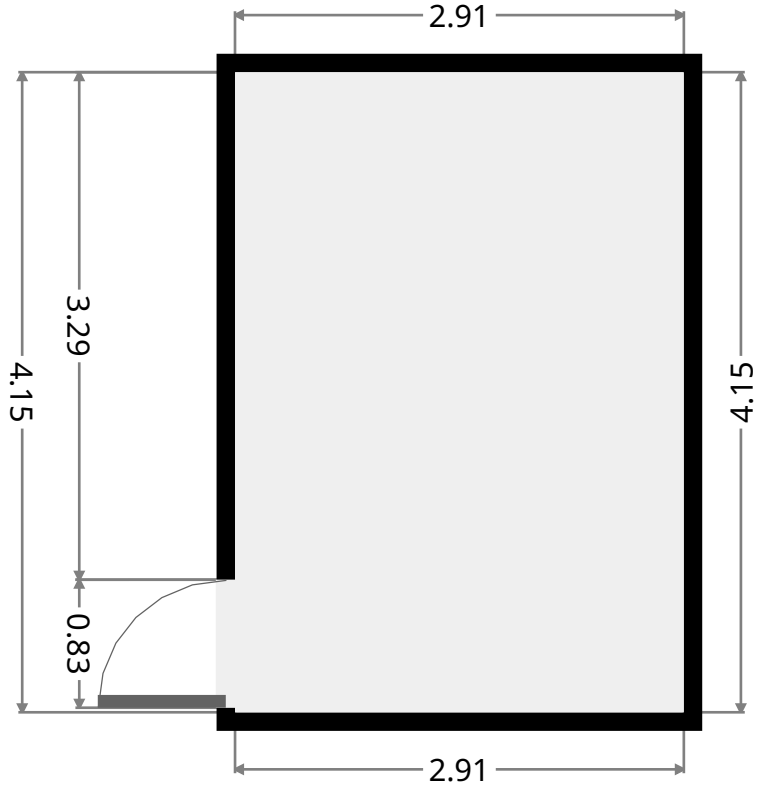
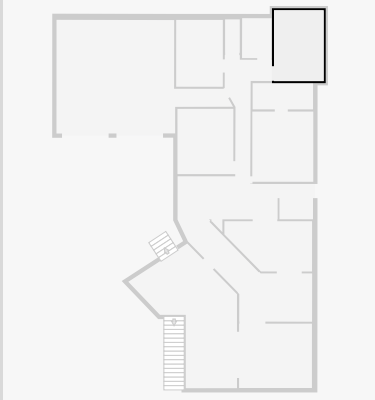

Bathroom

Width: 1.72 m
Length: 2.34 m
Area: 4.04 m²
Perimeter: 8.14 m

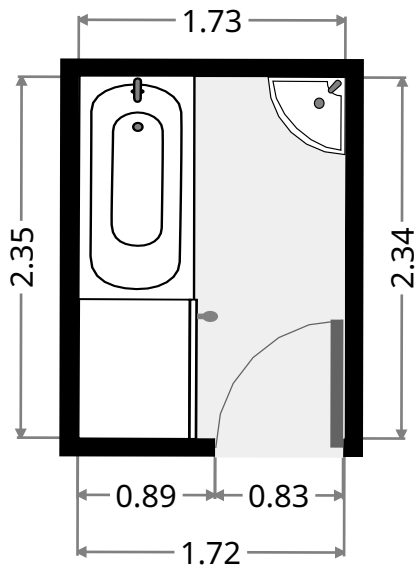
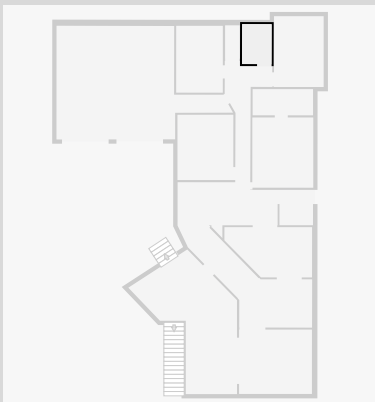

3 Langford Street

Toilet

Width: 0.85 m
Length: 1.96 m
Area: 1.68 m²
Perimeter: 5.63 m

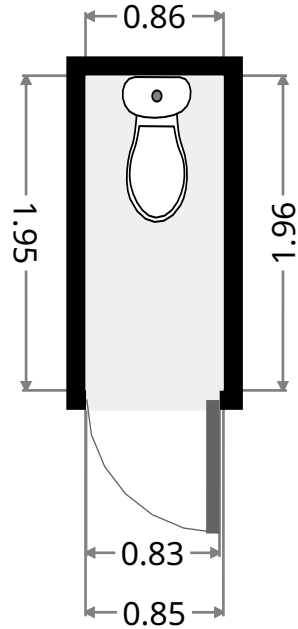
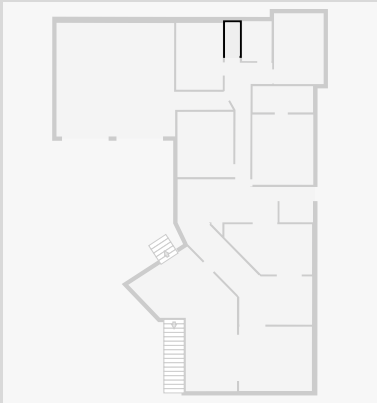

Bedroom

Width: 2.73 m
Length: 3.92 m
Area: 10.70 m²
Perimeter: 13.30 m

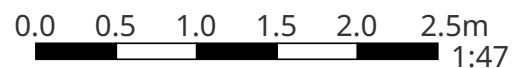
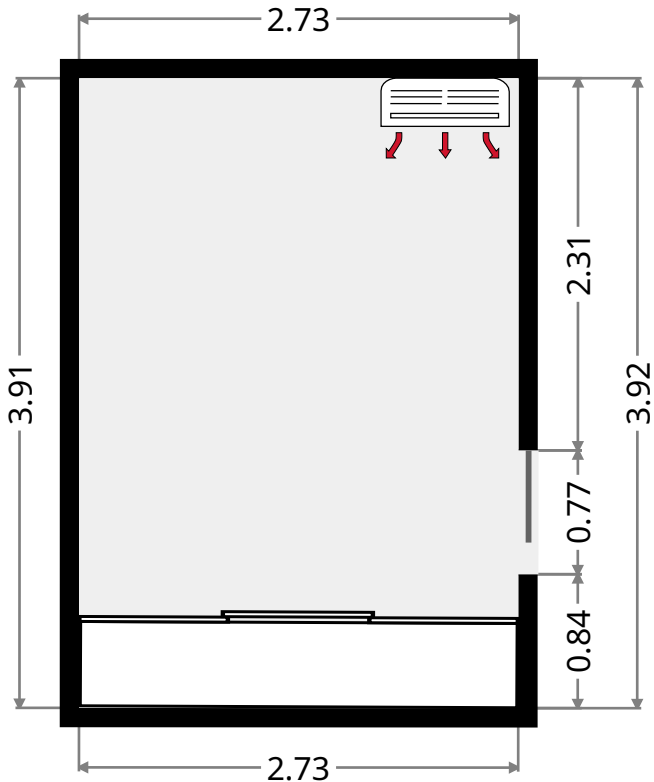
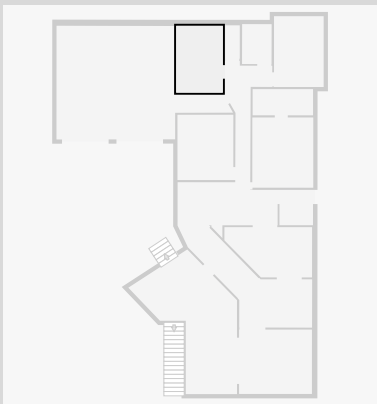

THIS FLOORPLAN IS PROVIDED WITHOUT WARRANTY OF ANY KIND. SENSOPIA DISCLAIMS ANY WARRANTY INCLUDING, WITHOUT LIMITATION, SATISFACTORY QUALITY OR ACCURACY OF DIMENSIONS.

3 Langford Street

Bedroom

Width: 3.27 m
 Length: 3.83 m
 Area: 12.53 m²
 Perimeter: 14.20 m

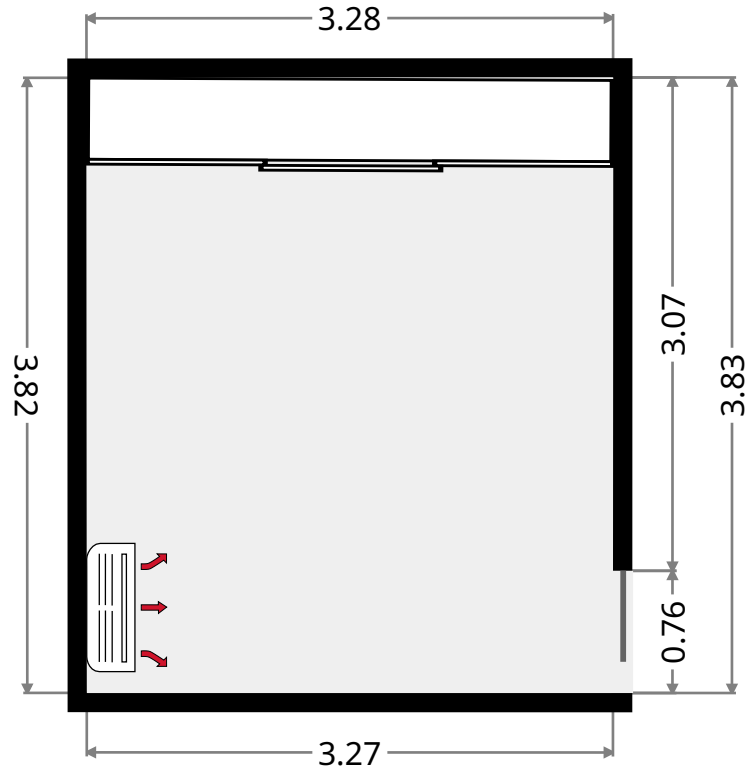
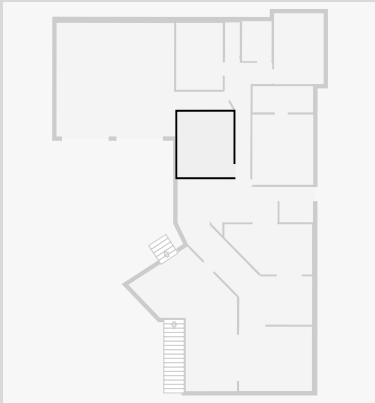

Bathroom

Width: 1.53 m
 Length: 3.54 m
 Area: 5.44 m²
 Perimeter: 10.15 m

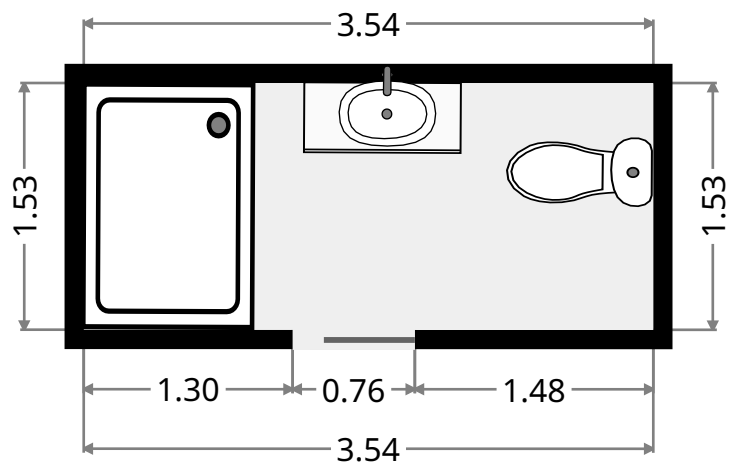
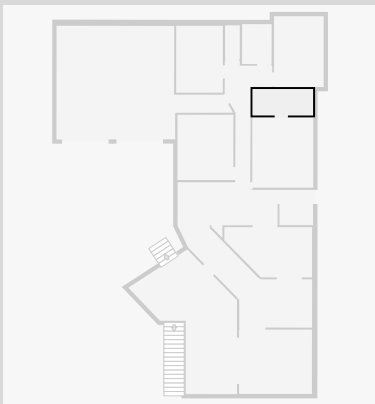

THIS FLOORPLAN IS PROVIDED WITHOUT WARRANTY OF ANY KIND. SENSOPIA DISCLAIMS ANY WARRANTY INCLUDING, WITHOUT LIMITATION, SATISFACTORY QUALITY OR ACCURACY OF DIMENSIONS.

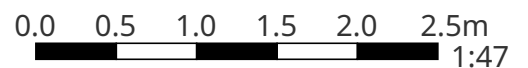

3 Langford Street

Hall

Width: 1.70 m
 Length: 4.11 m
 Area: 6.98 m²
 Perimeter: 11.62 m

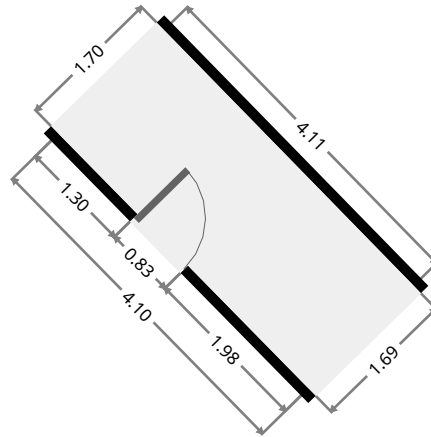

Hall

Width: 2.78 m
 Length: 6.99 m
 Area: 9.13 m²
 Perimeter: 19.07 m

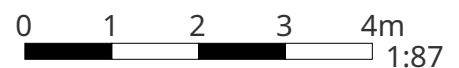
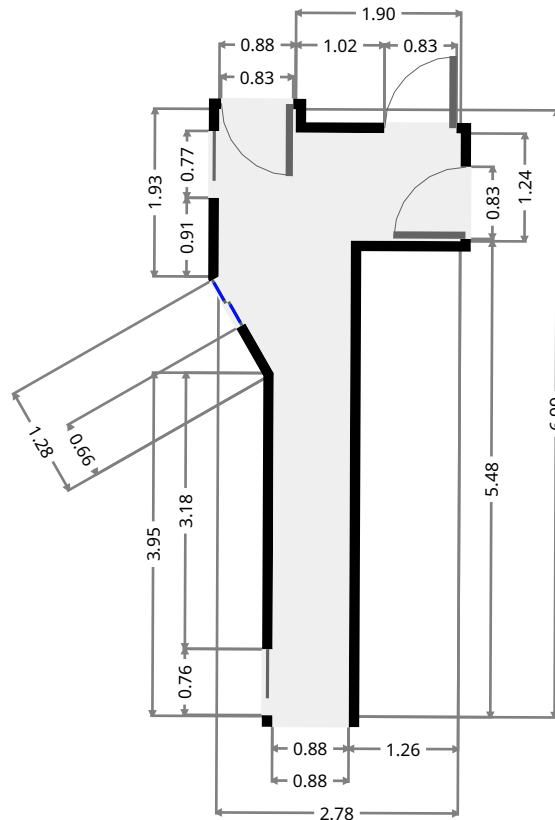
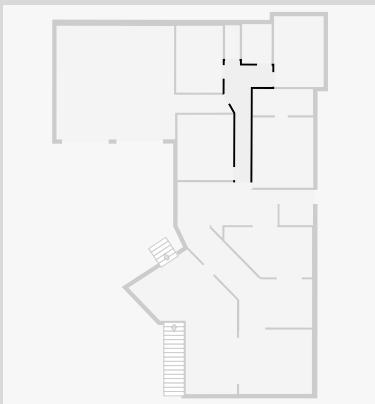

THIS FLOORPLAN IS PROVIDED WITHOUT WARRANTY OF ANY KIND. SENSOPIA DISCLAIMS ANY WARRANTY INCLUDING, WITHOUT LIMITATION, SATISFACTORY QUALITY OR ACCURACY OF DIMENSIONS.

3 Langford Street

Closet

Width: 0.00 m
 Length: 0.88 m
 Area: 0.19 m²
 Perimeter: 2.12 m

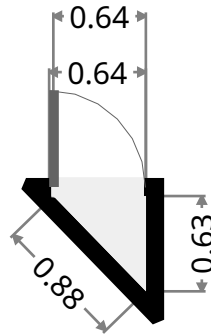

Kitchen

Width: 2.95 m
 Length: 5.14 m
 Area: 12.80 m²
 Perimeter: 14.90 m

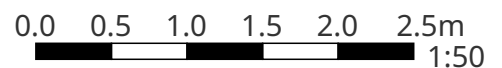
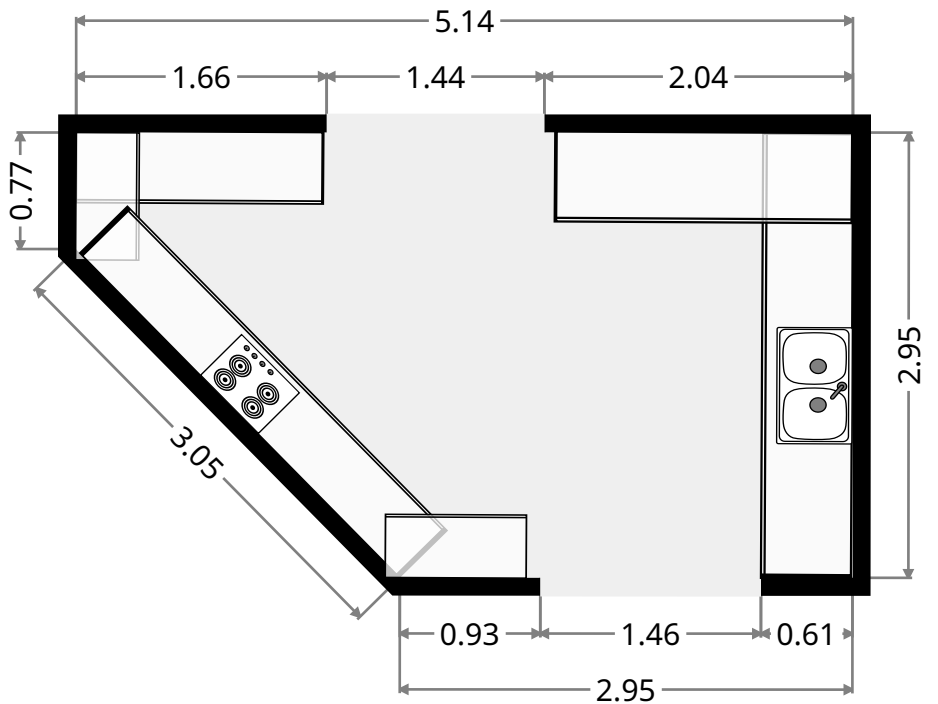
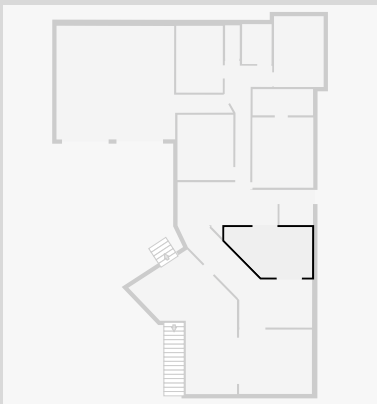

THIS FLOORPLAN IS PROVIDED WITHOUT WARRANTY OF ANY KIND. SENSOPIA DISCLAIMS ANY WARRANTY INCLUDING, WITHOUT LIMITATION, SATISFACTORY QUALITY OR ACCURACY OF DIMENSIONS.

3 Langford Street

Laundry Room

Width: 1.97 m
 Length: 2.07 m
 Area: 4.07 m²
 Perimeter: 8.07 m

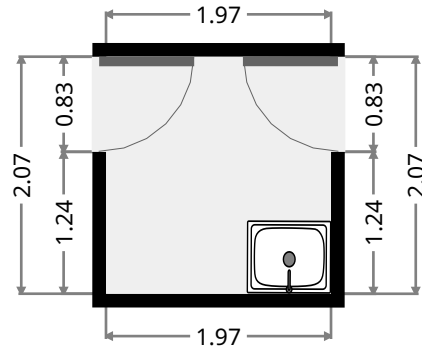
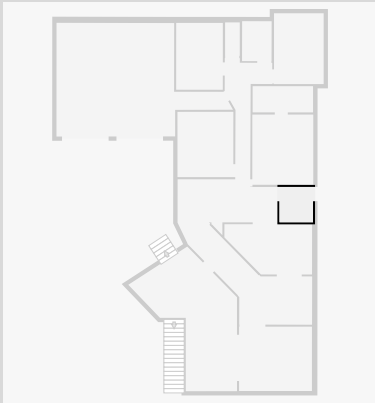

Dining Room

Width: 2.54 m
 Length: 5.86 m
 Area: 15.21 m²
 Perimeter: 18.06 m

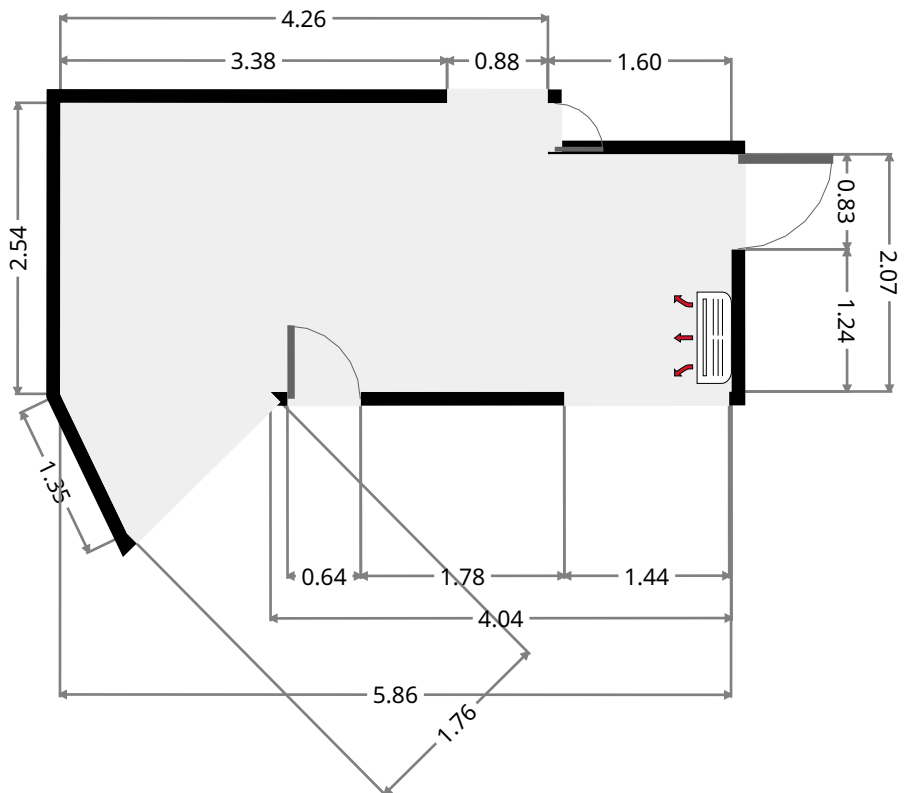

3 Langford Street

Living Room

Width: 3.77 m
 Length: 4.27 m
 Area: 16.10 m²
 Perimeter: 16.08 m

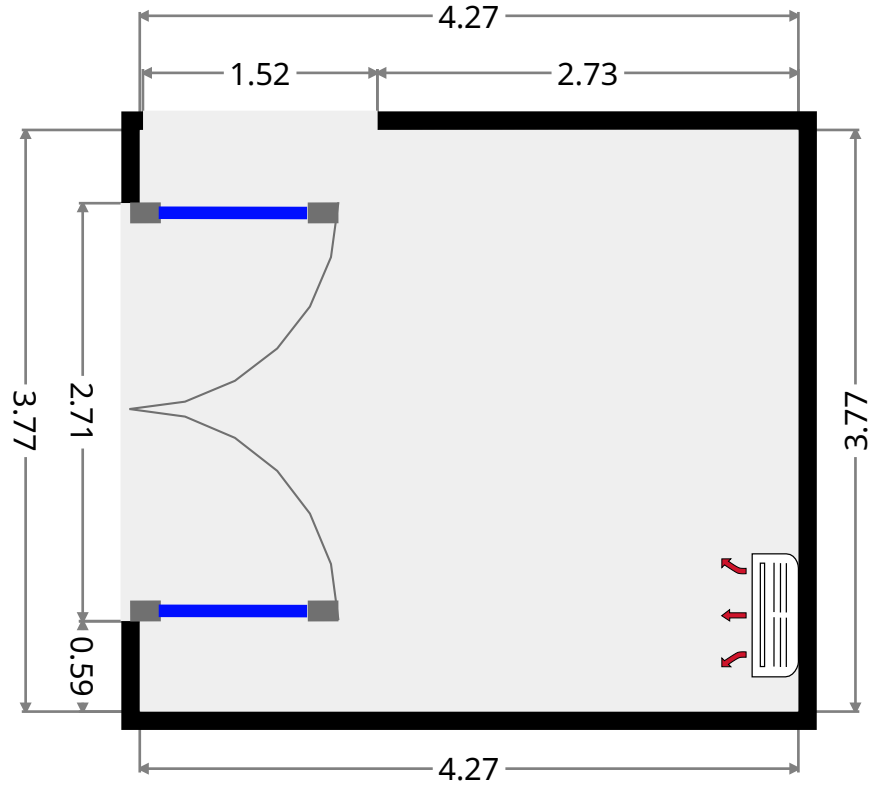

Formal Dining

Width: 2.83 m
 Length: 4.27 m
 Area: 11.32 m²
 Perimeter: 13.48 m

