

3 Emery Street

Ground Floor



THIS FLOORPLAN IS PROVIDED WITHOUT WARRANTY OF ANY KIND. SENSOPIA DISCLAIMS ANY WARRANTY INCLUDING, WITHOUT LIMITATION, SATISFACTORY QUALITY OR ACCURACY OF DIMENSIONS.



3 Emery Street

Living Room

Width: 5.75 m
 Length: 9.38 m
 Area: 35.82 m²
 Perimeter: 30.24 m

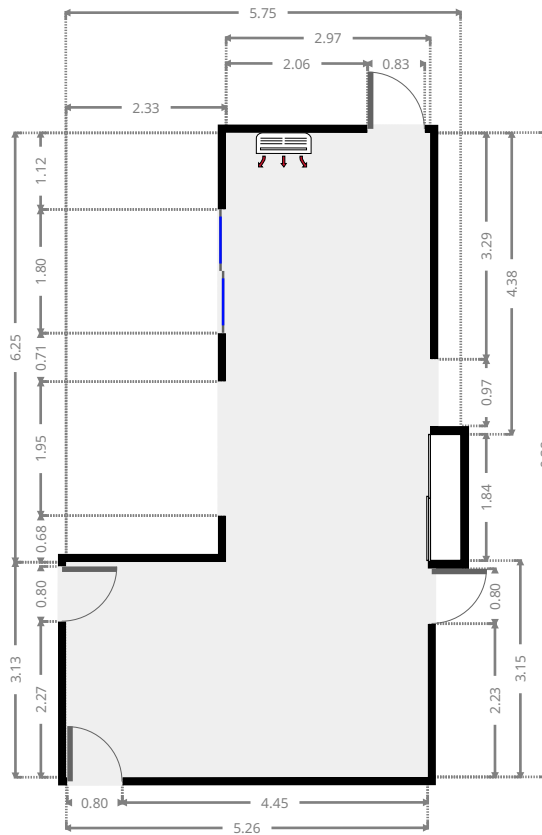
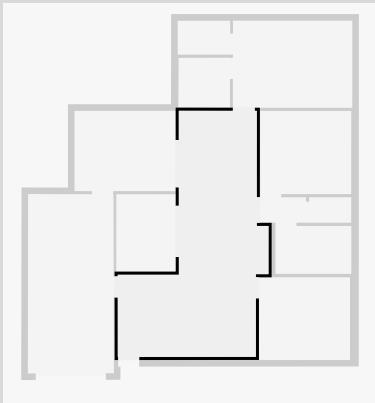

Kitchen

Width: 2.30 m
 Length: 2.95 m
 Area: 6.77 m²
 Perimeter: 10.49 m

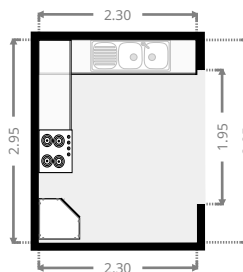
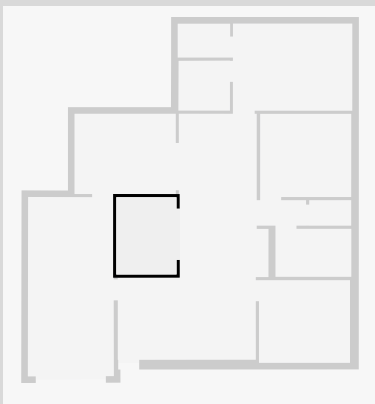

3 Emery Street

Master Bedroom

Width: 3.32 m
Length: 4.55 m
Area: 15.10 m²
Perimeter: 15.74 m

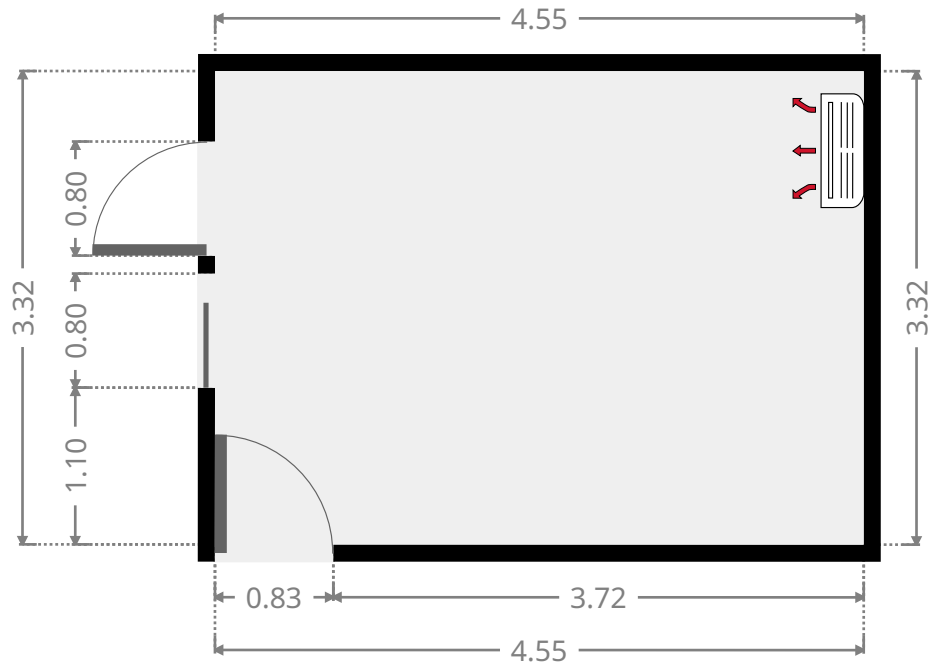
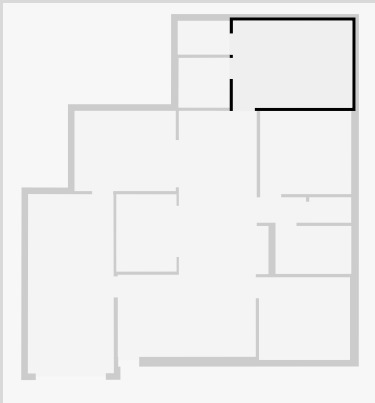

Closet

Width: 1.29 m
Length: 2.00 m
Area: 2.58 m²
Perimeter: 6.58 m

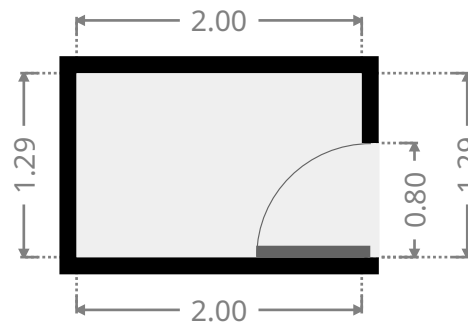
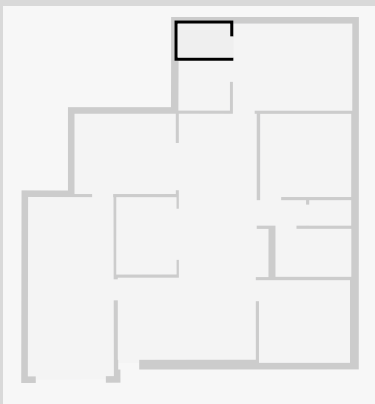

3 Emery Street

Bathroom

Width: 1.91 m
Length: 1.97 m
Area: 3.73 m²
Perimeter: 7.73 m

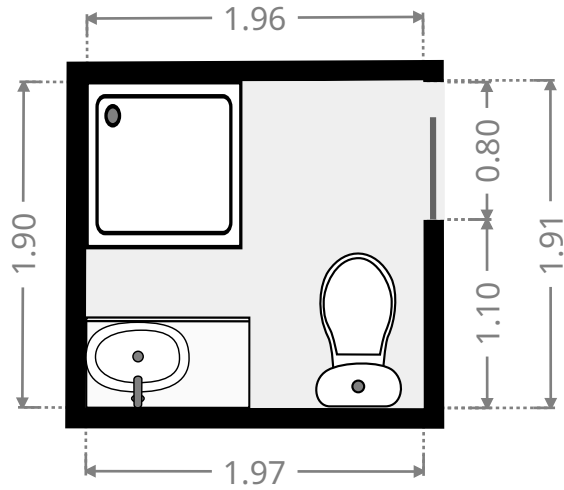
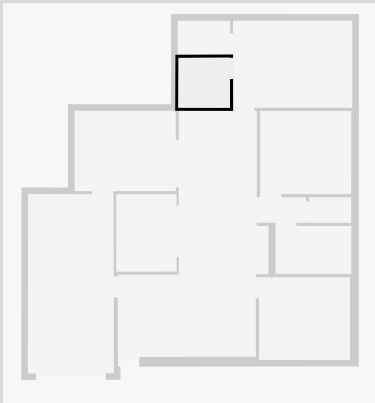

Bedroom

Width: 3.17 m
Length: 3.47 m
Area: 11.00 m²
Perimeter: 13.28 m

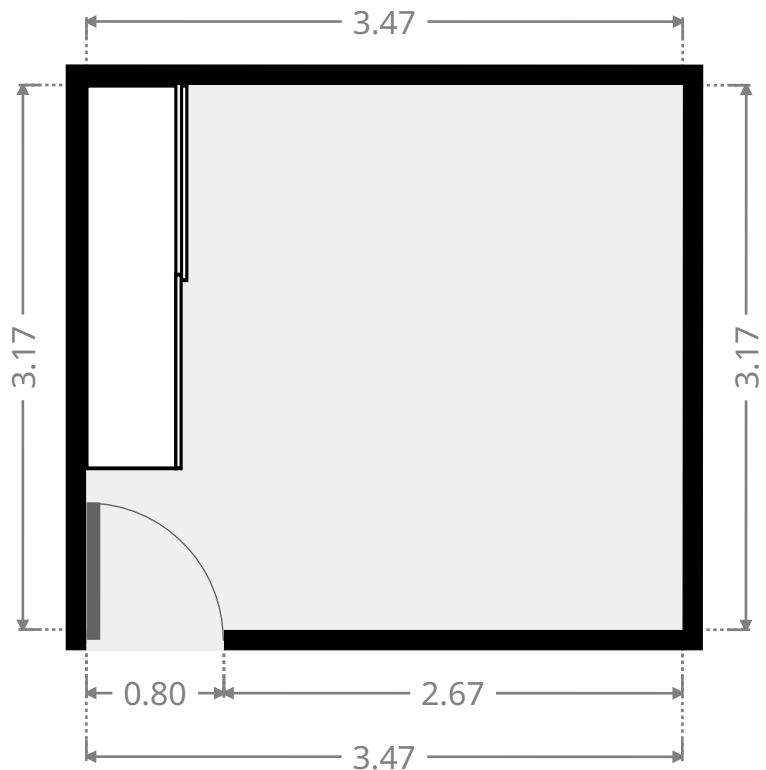
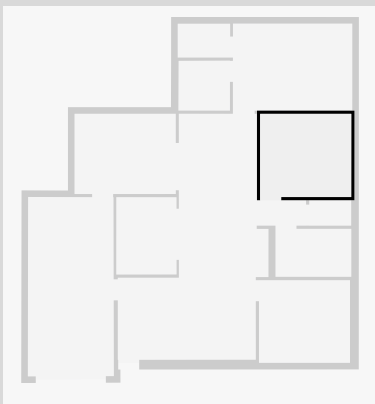

3 Emery Street

Hall

Width: 0.97 m
Length: 1.76 m
Area: 1.71 m²
Perimeter: 5.46 m

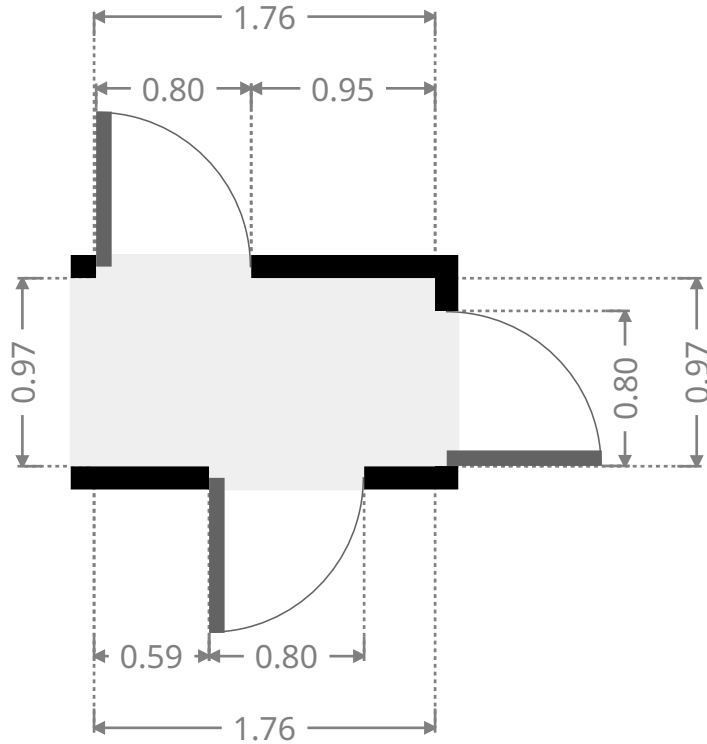
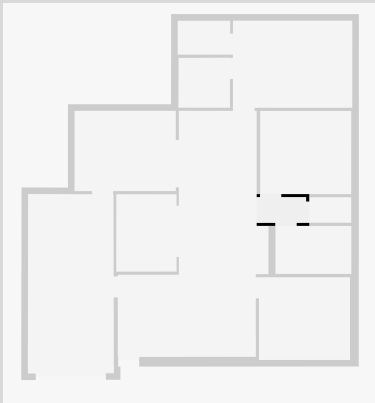

Toilet / Half Bath

Width: 0.97 m
Length: 1.60 m
Area: 1.55 m²
Perimeter: 5.14 m

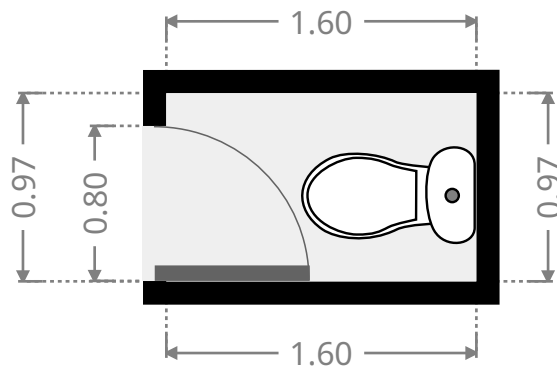
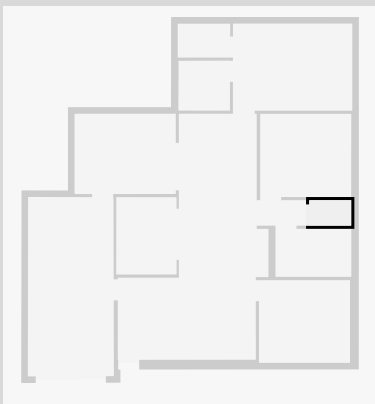

3 Emery Street

Bathroom

Width: 1.83 m
Length: 2.89 m
Area: 5.29 m²
Perimeter: 9.44 m

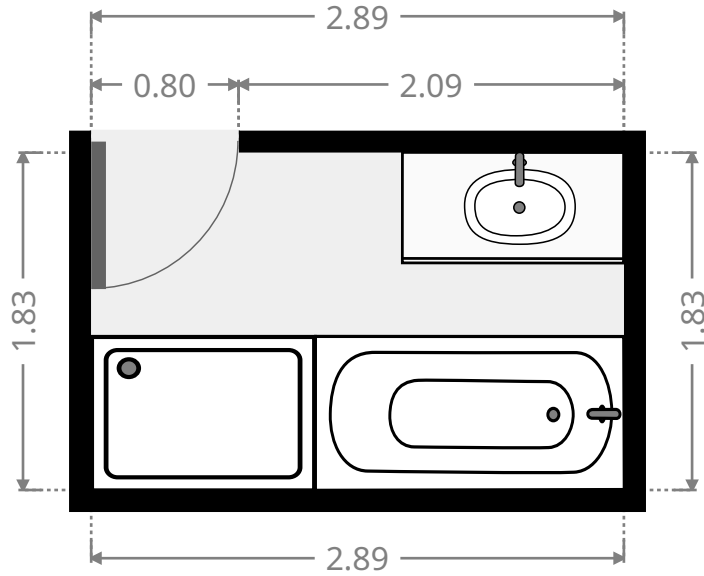
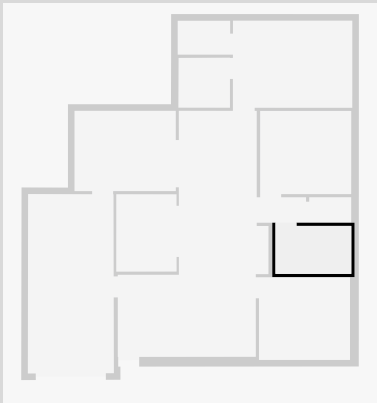

Bedroom

Width: 3.15 m
Length: 3.47 m
Area: 10.93 m²
Perimeter: 13.24 m

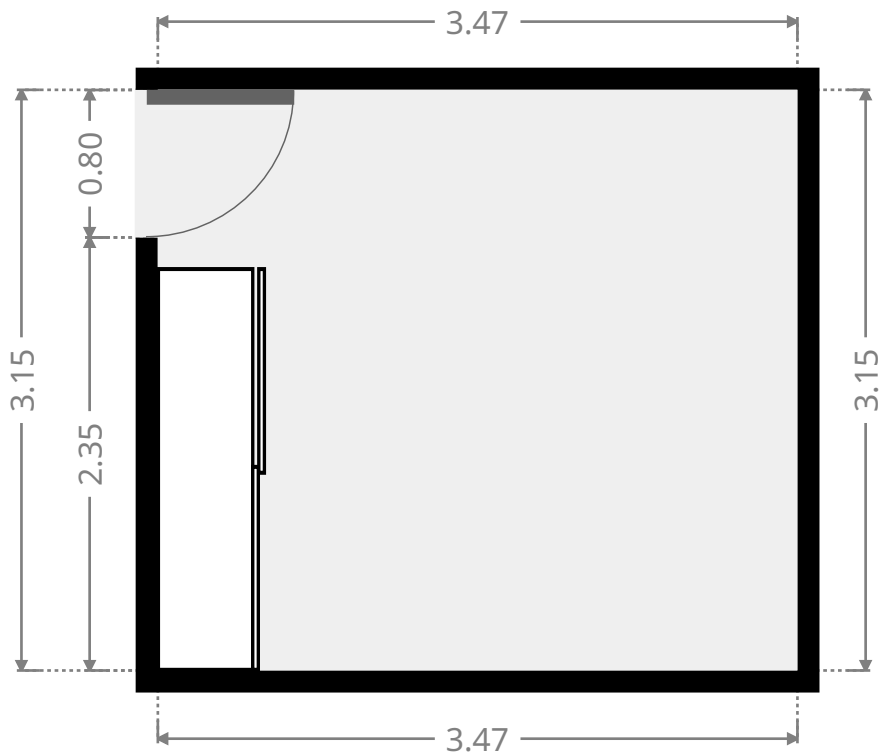
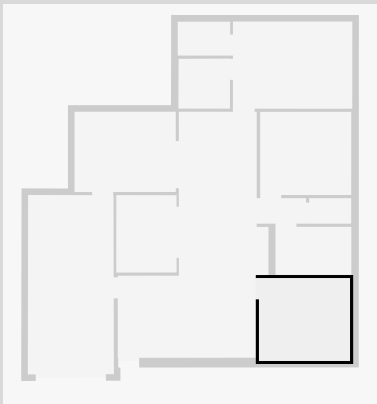

THIS FLOORPLAN IS PROVIDED WITHOUT WARRANTY OF ANY KIND. SENSOPIA DISCLAIMS ANY WARRANTY INCLUDING, WITHOUT LIMITATION, SATISFACTORY QUALITY OR ACCURACY OF DIMENSIONS.

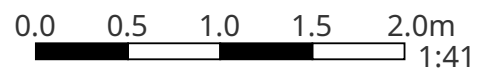

3 Emery Street

Garage

Width: 3.29 m
 Length: 6.84 m
 Area: 22.31 m²
 Perimeter: 20.19 m

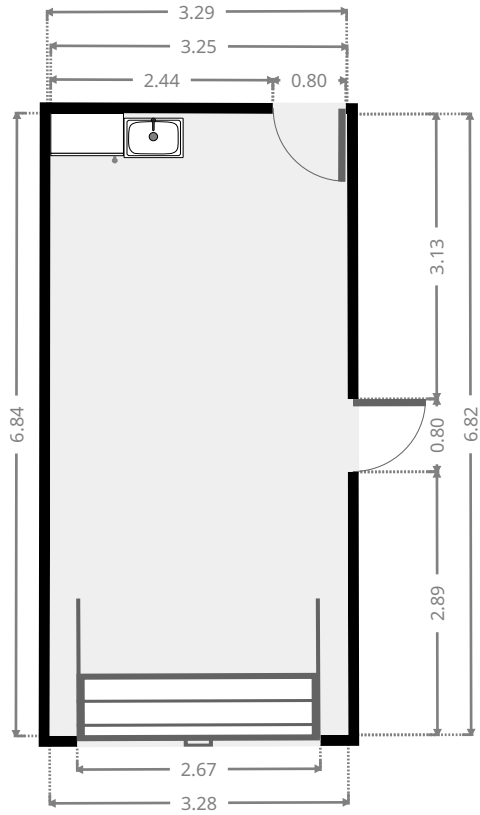
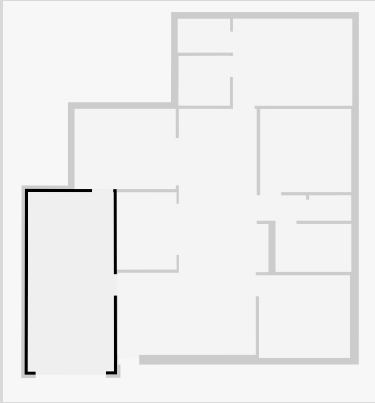

Outdoor Area

Width: 3.06 m
 Length: 3.86 m
 Area: 11.81 m²
 Perimeter: 13.84 m

