

3 Annie Close

Created on
2020-07-27

Floors
1

▼ Ground Floor



▼ Kitchen Ground Floor

WIDTH: 8.75 m • LENGTH: 11.88 m
AREA: 53.65 m² • PERIMETER: 43.53 m

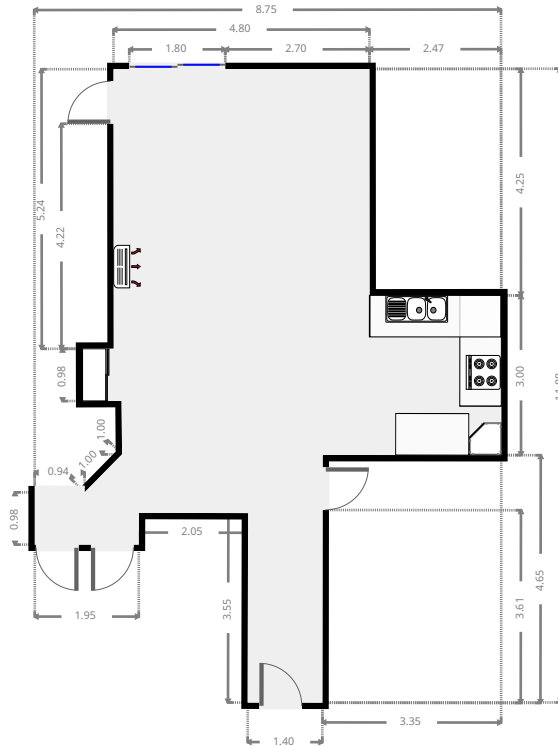
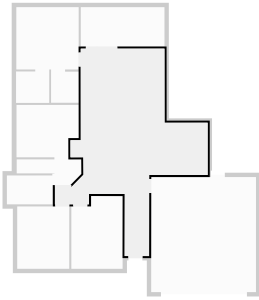

▼ Master Bedroom Ground Floor

WIDTH: 3.57 m • LENGTH: 3.57 m
AREA: 12.74 m² • PERIMETER: 14.28 m

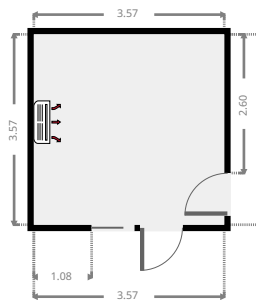
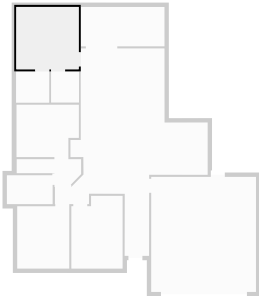

FLOORS: 1

▼ Closet Ground Floor

WIDTH: 1.60 m • LENGTH: 1.78 m
AREA: 2.85 m² • PERIMETER: 6.76 m

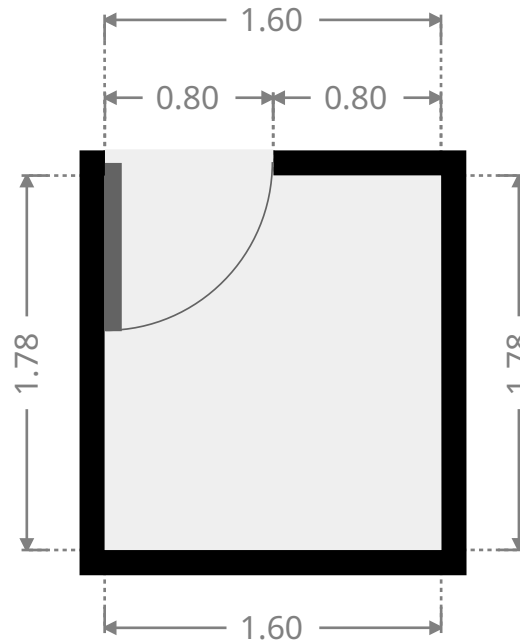
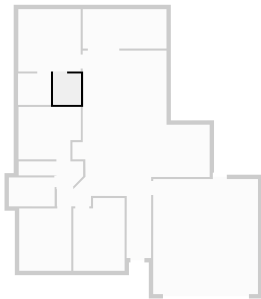

▼ Bathroom Ground Floor

WIDTH: 1.90 m • LENGTH: 1.80 m
AREA: 3.42 m² • PERIMETER: 7.40 m

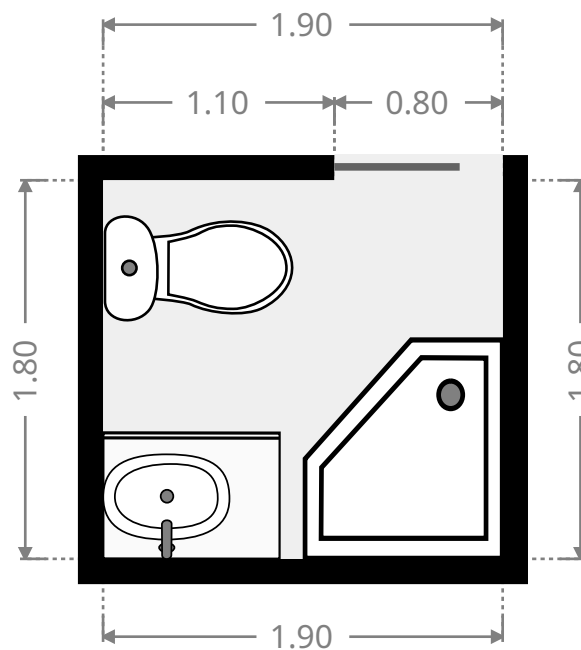
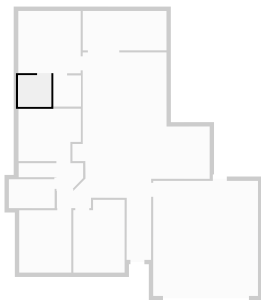

FLOORS: 1

▼ Bedroom Ground Floor

WIDTH: 3.57 m • LENGTH: 3.00 m
AREA: 10.05 m² • PERIMETER: 13.14 m

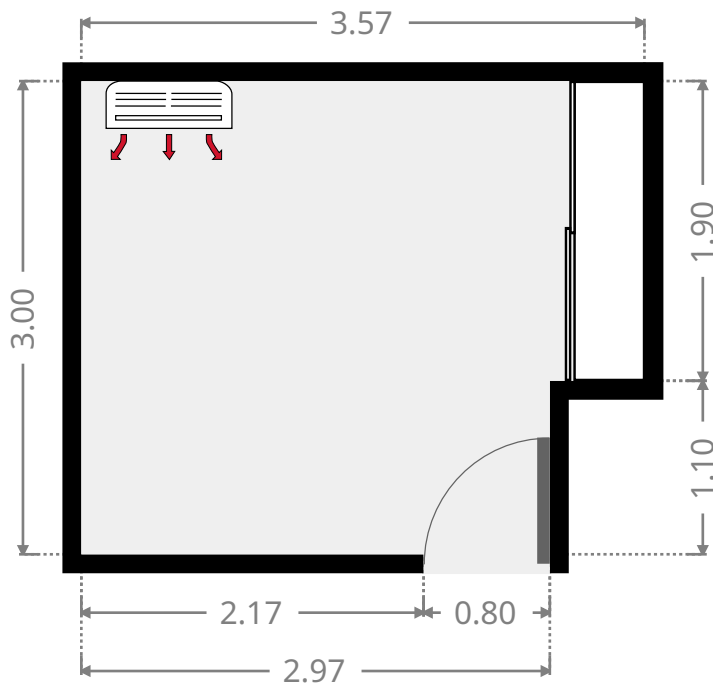
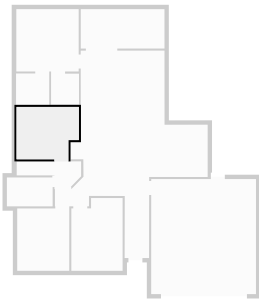

▼ Hall Ground Floor

WIDTH: 1.91 m • LENGTH: 1.47 m
AREA: 2.35 m² • PERIMETER: 6.38 m

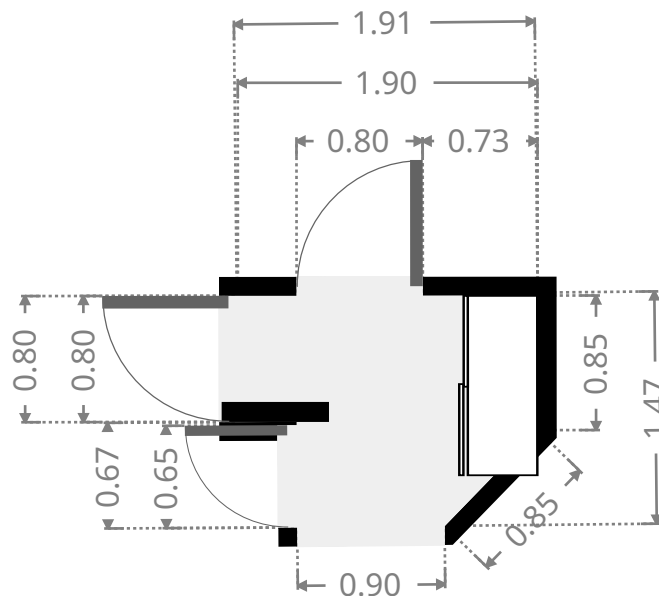
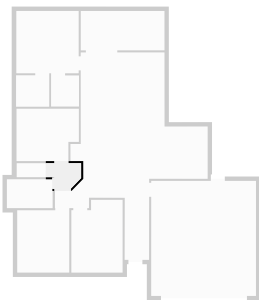

3 Annie Close

FLOORS: 1

▼ Toilet Ground Floor

WIDTH: 1.65 m • LENGTH: 0.80 m
AREA: 1.32 m² • PERIMETER: 4.90 m

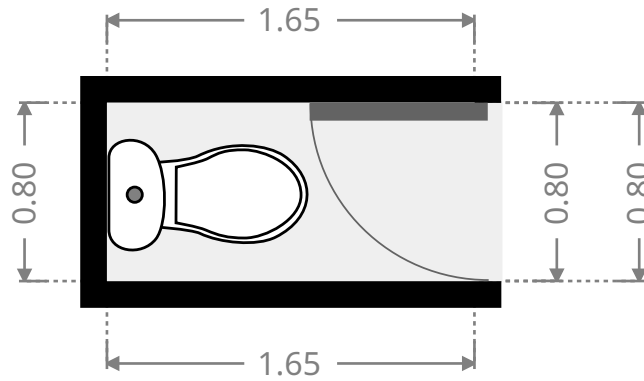
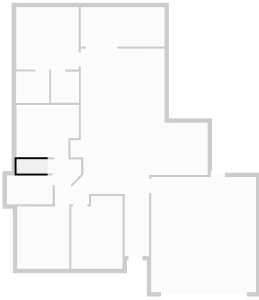

▼ Bathroom Ground Floor

WIDTH: 2.62 m • LENGTH: 1.65 m
AREA: 4.33 m² • PERIMETER: 8.54 m

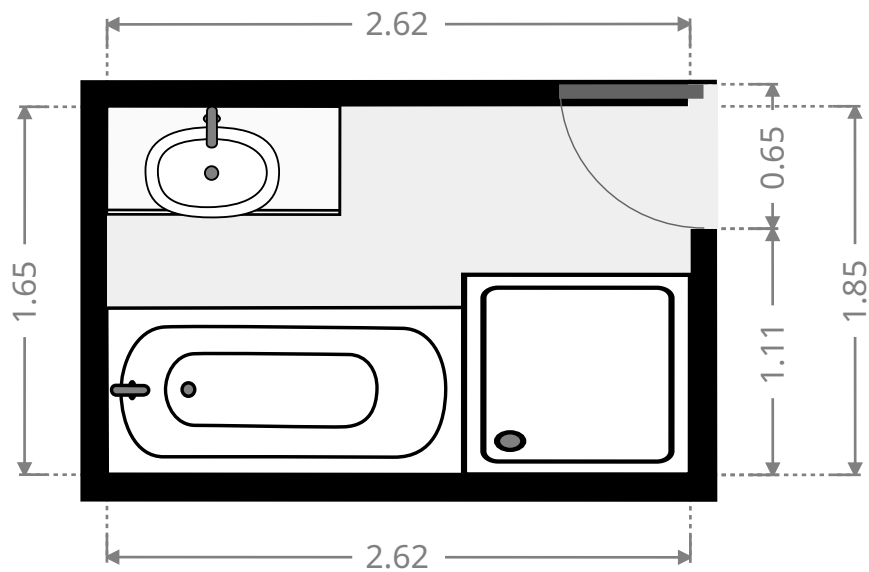
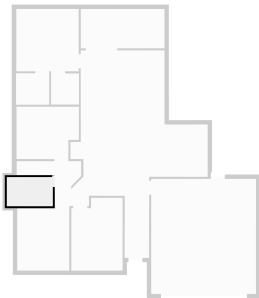

FLOORS: 1

▼ Bedroom Ground Floor

WIDTH: 2.98 m • LENGTH: 3.57 m
AREA: 10.64 m² • PERIMETER: 13.10 m

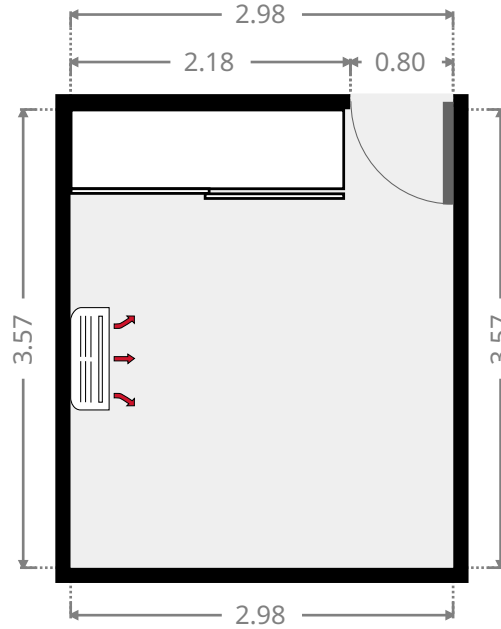
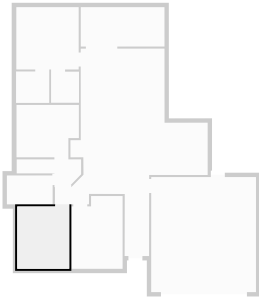

▼ Bedroom Ground Floor

WIDTH: 2.94 m • LENGTH: 4.17 m
AREA: 11.57 m² • PERIMETER: 14.21 m

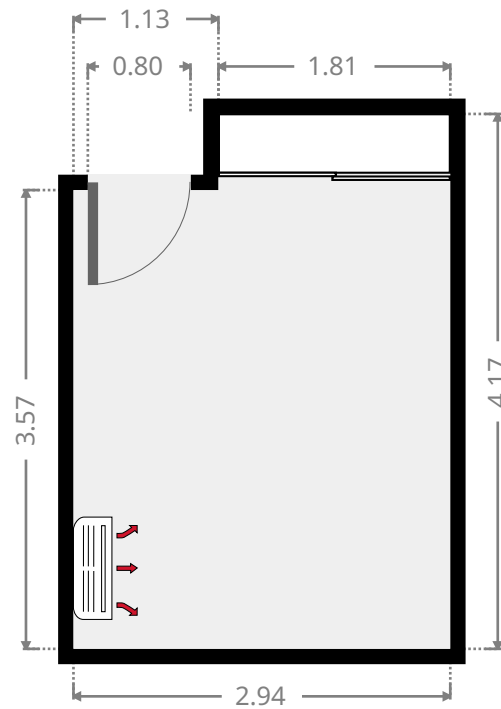
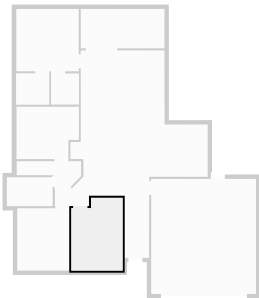

FLOORS: 1

▼ Garage Ground Floor

WIDTH: 6.00 m • LENGTH: 6.59 m
AREA: 39.54 m² • PERIMETER: 25.18 m

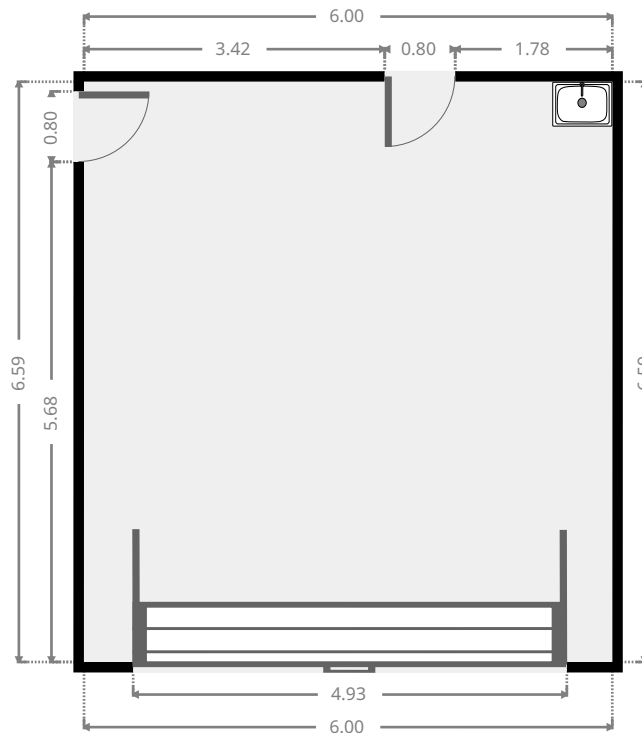
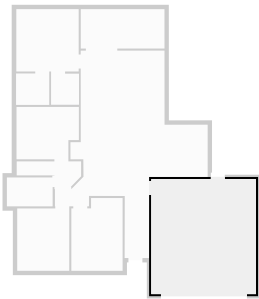

▼ Other Ground Floor

WIDTH: 4.80 m • LENGTH: 2.26 m
AREA: 10.81 m² • PERIMETER: 14.10 m

