

3/18 Bruce Hiskens Court

Created on
2021-05-24

Floors
1

▼ Ground Floor

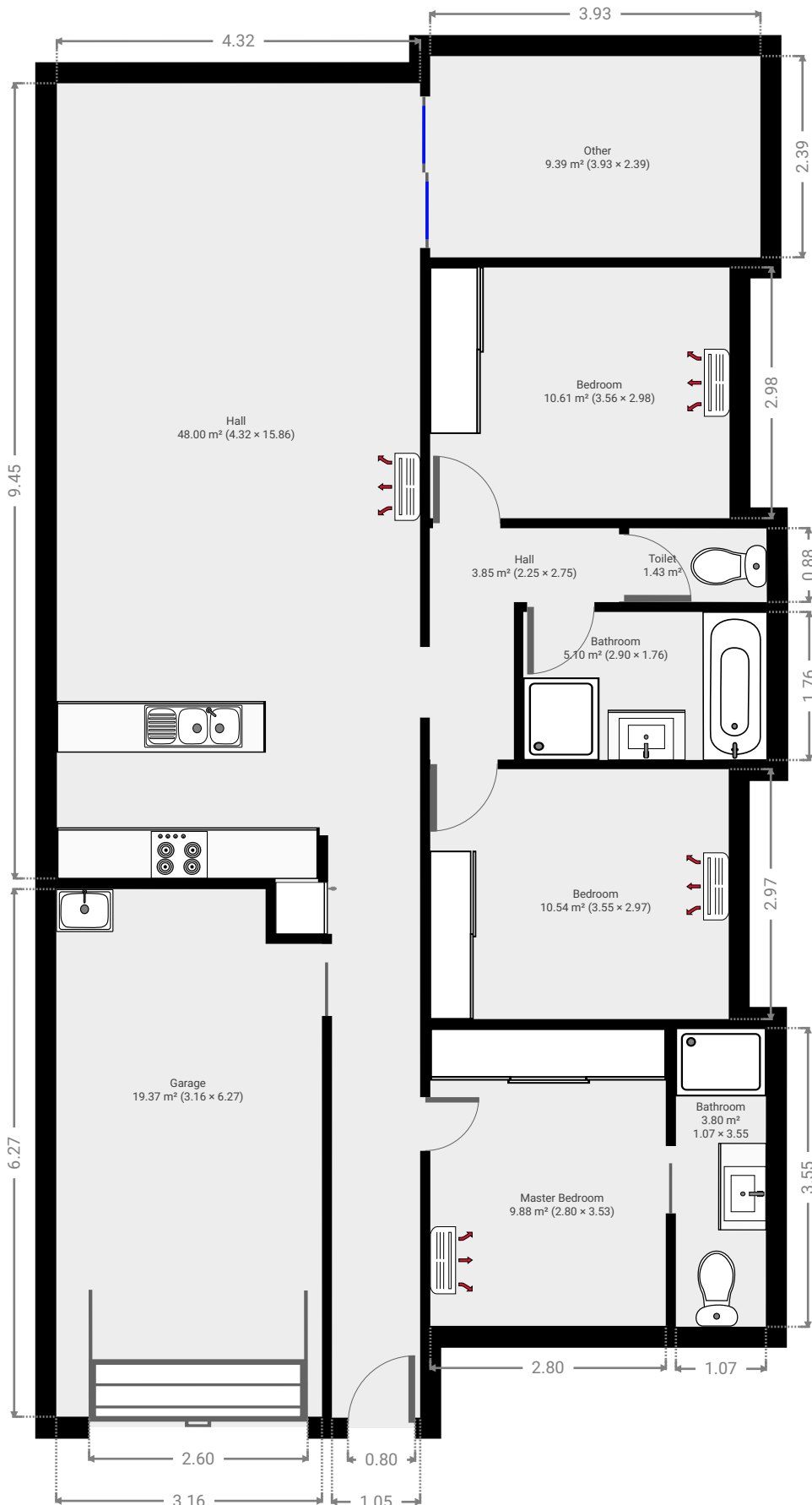

▼ Hall Ground Floor

WIDTH: 4.32 m • LENGTH: 15.86 m
AREA: 48.00 m² • PERIMETER: 40.36 m

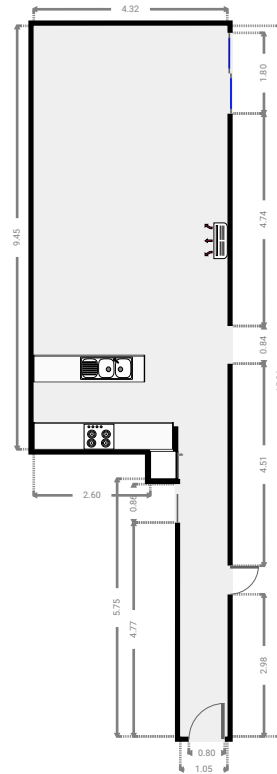
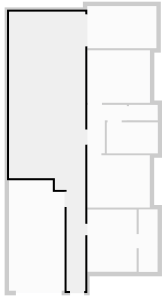

▼ Master Bedroom Ground Floor

WIDTH: 2.80 m • LENGTH: 3.53 m
AREA: 9.88 m² • PERIMETER: 12.66 m

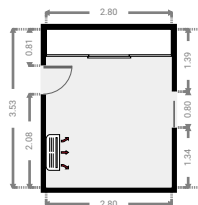
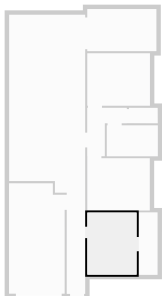

▼ Bathroom Ground Floor

WIDTH: 1.07 m • LENGTH: 3.55 m
AREA: 3.80 m² • PERIMETER: 9.24 m

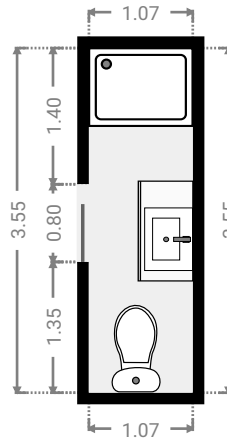
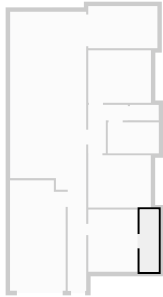

▼ Garage Ground Floor

WIDTH: 3.16 m • LENGTH: 6.27 m
AREA: 19.37 m² • PERIMETER: 18.86 m

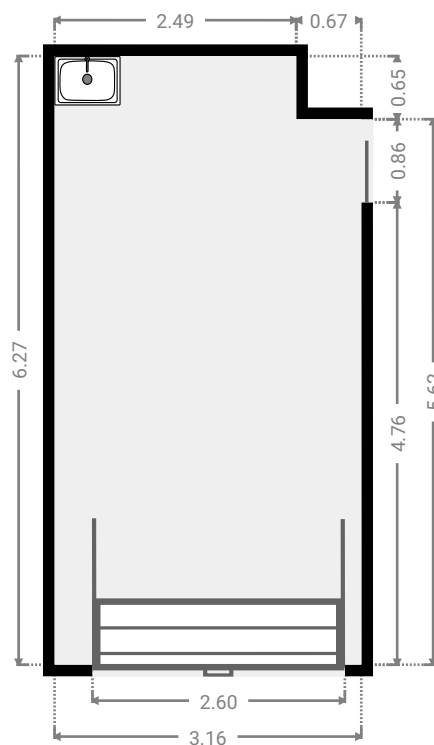
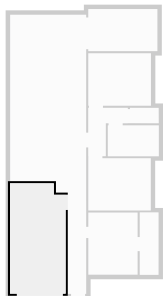

▼ **Bedroom**
Ground Floor

WIDTH: 3.55 m • LENGTH: 2.97 m
AREA: 10.54 m² • PERIMETER: 13.04 m

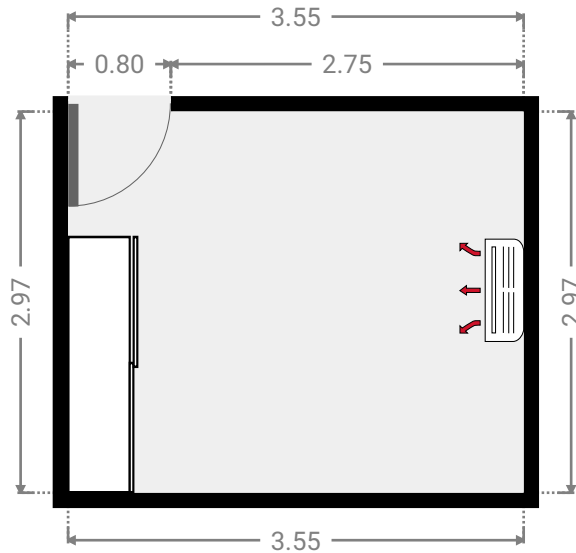
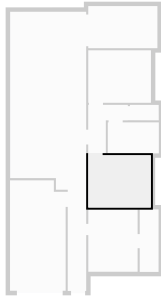

▼ **Hall**
Ground Floor

WIDTH: 2.25 m • LENGTH: 2.75 m
AREA: 3.85 m² • PERIMETER: 10.00 m

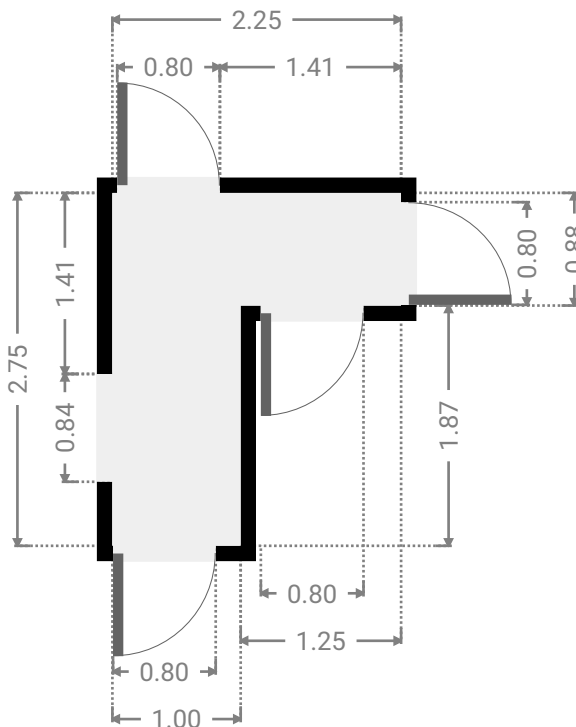
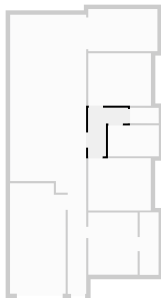

FLOORS: 1

▼ **Bathroom**
Ground Floor

WIDTH: 2.90 m • LENGTH: 1.76 m
AREA: 5.10 m² • PERIMETER: 9.32 m

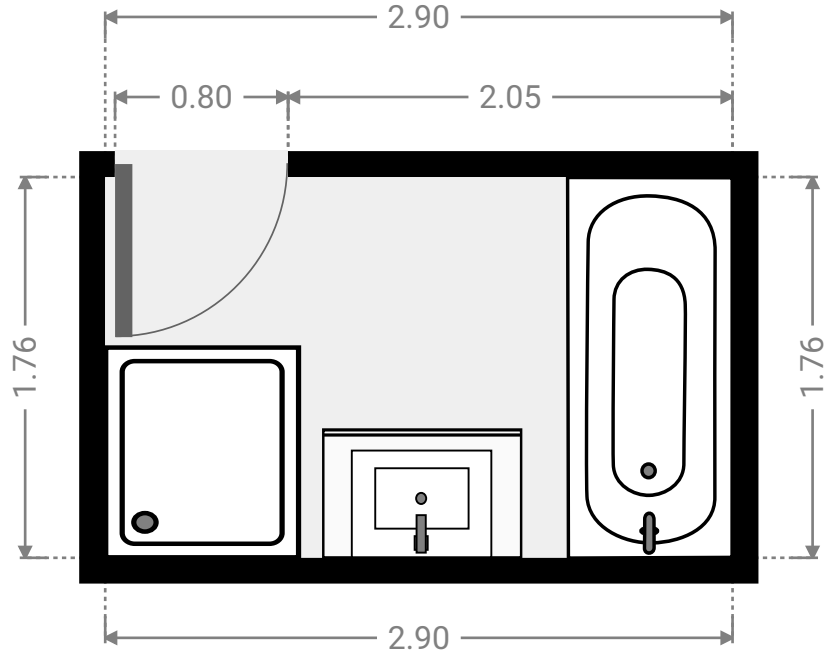
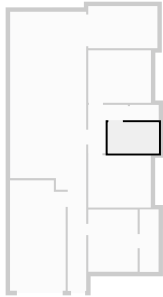

▼ **Toilet**
Ground Floor

WIDTH: 1.64 m • LENGTH: 0.88 m
AREA: 1.43 m² • PERIMETER: 5.02 m

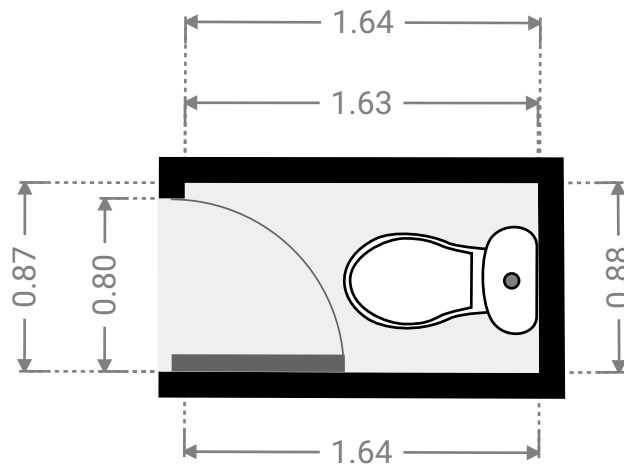
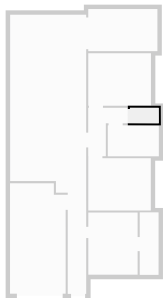

▼ **Bedroom**
Ground Floor

WIDTH: 3.56 m • LENGTH: 2.98 m
AREA: 10.61 m² • PERIMETER: 13.08 m

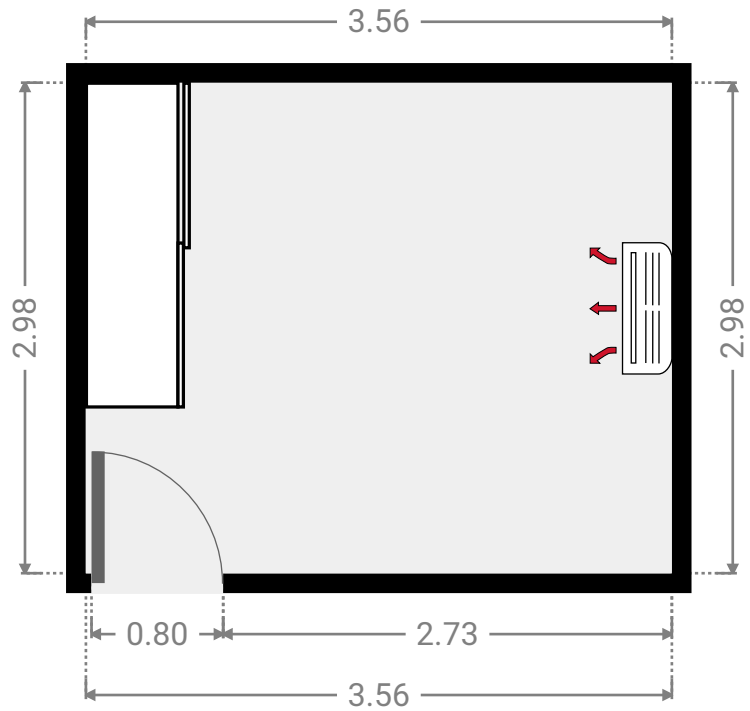
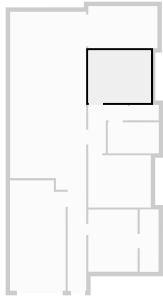

▼ **Other**
Ground Floor

WIDTH: 3.93 m • LENGTH: 2.39 m
AREA: 9.39 m² • PERIMETER: 12.64 m

