

3/10 Hassell Street

Ground Floor



THIS FLOORPLAN IS PROVIDED WITHOUT WARRANTY OF ANY KIND. SENSOPIA DISCLAIMS ANY WARRANTY INCLUDING, WITHOUT LIMITATION, SATISFACTORY QUALITY OR ACCURACY OF DIMENSIONS.

3/10 Hassell Street

Hall

Width: 1.99 m
Length: 5.51 m
Area: 6.09 m²
Perimeter: 13.37 m

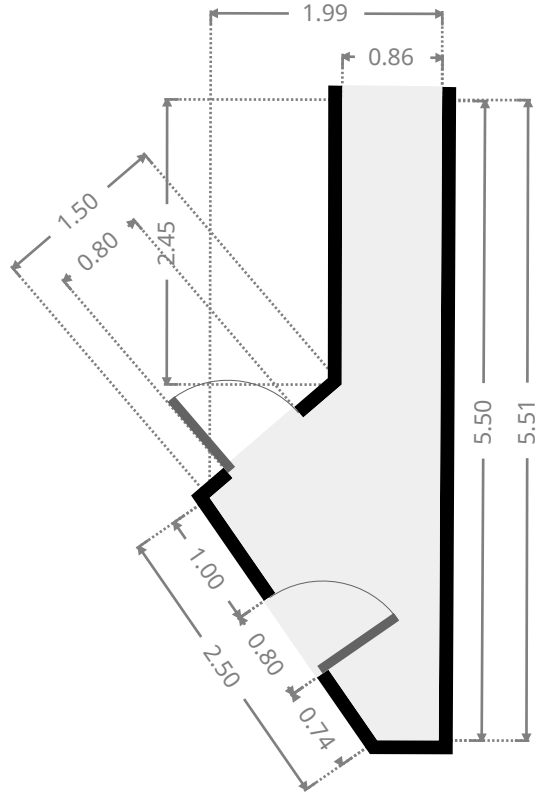
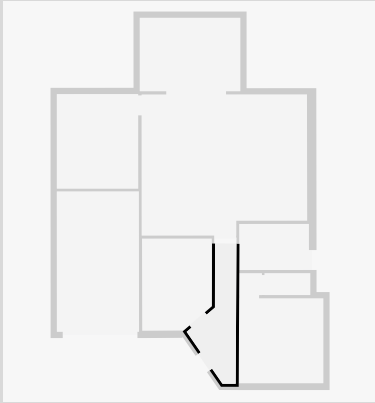

Bedroom

Width: 2.81 m
Length: 3.70 m
Area: 9.79 m²
Perimeter: 12.38 m

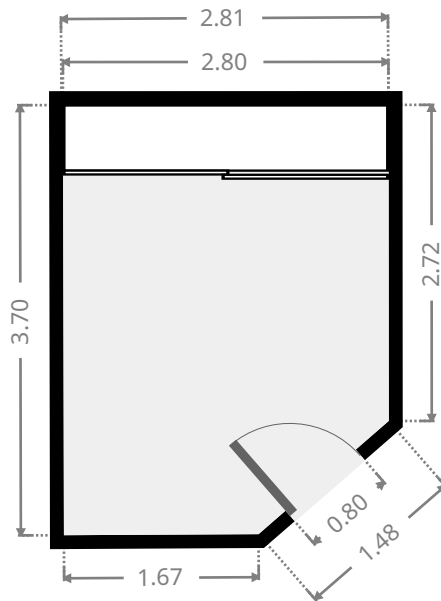
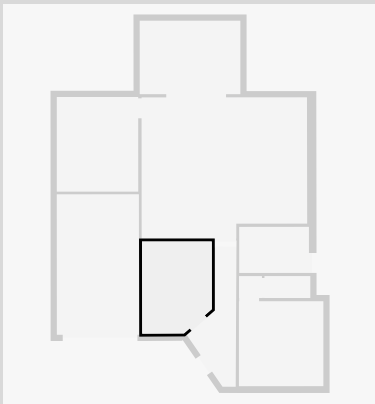

THIS FLOORPLAN IS PROVIDED WITHOUT WARRANTY OF ANY KIND. SENSOPIA DISCLAIMS ANY WARRANTY INCLUDING, WITHOUT LIMITATION, SATISFACTORY QUALITY OR ACCURACY OF DIMENSIONS.



3/10 Hassell Street

Bedroom

Width: 3.39 m
Length: 3.41 m
Area: 11.56 m²
Perimeter: 13.60 m

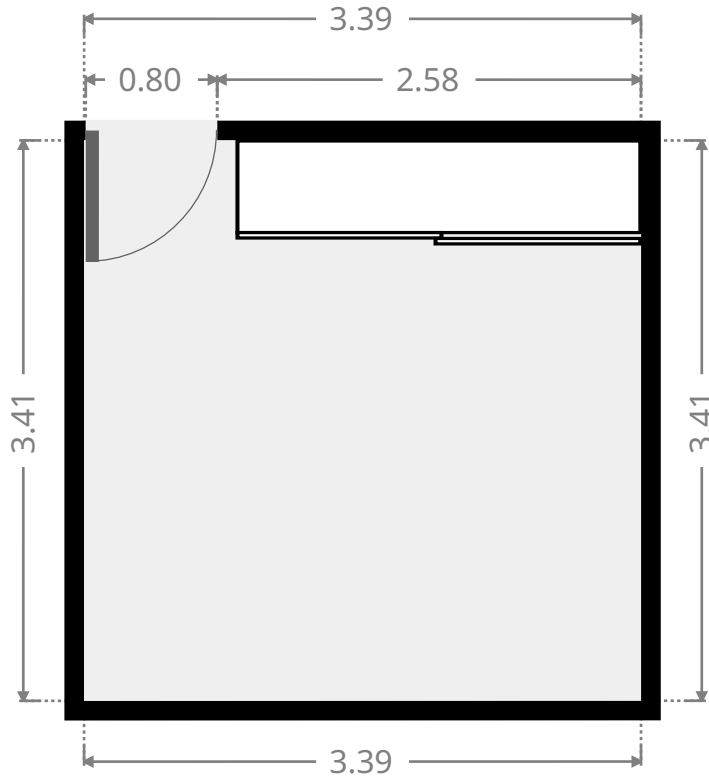
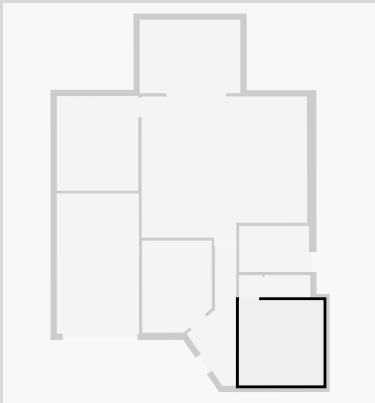

Hall

Width: 0.88 m
Length: 0.92 m
Area: 0.81 m²
Perimeter: 3.60 m

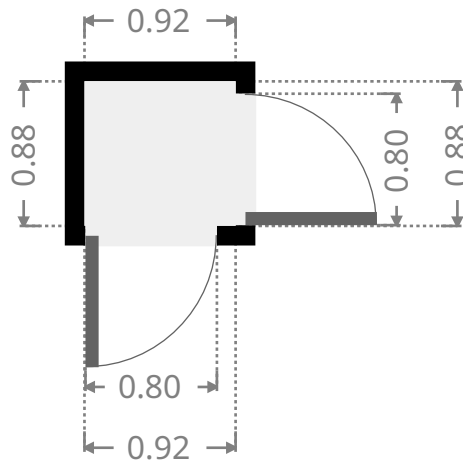
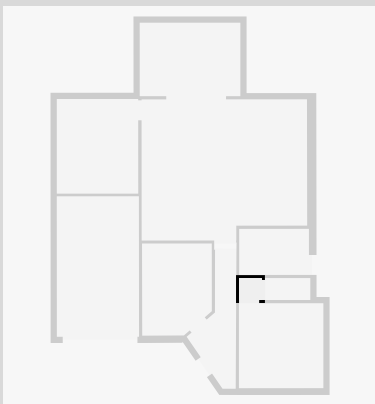

THIS FLOORPLAN IS PROVIDED WITHOUT WARRANTY OF ANY KIND. SENSOPIA DISCLAIMS ANY WARRANTY INCLUDING, WITHOUT LIMITATION, SATISFACTORY QUALITY OR ACCURACY OF DIMENSIONS.

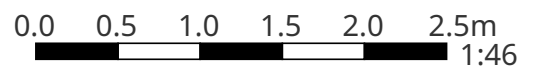

3/10 Hassell Street

Toilet / Half Bath

Width: 0.88 m
Length: 1.84 m
Area: 1.62 m²
Perimeter: 5.44 m

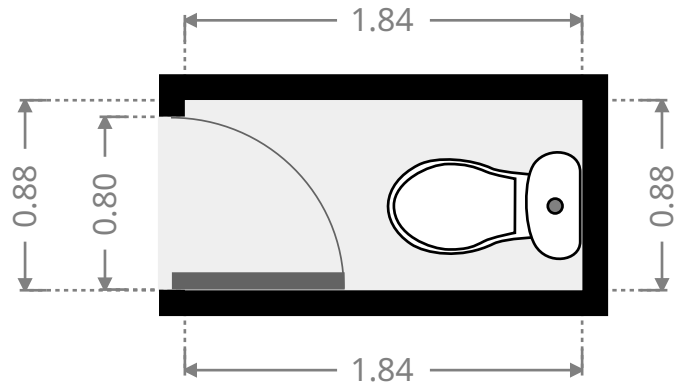
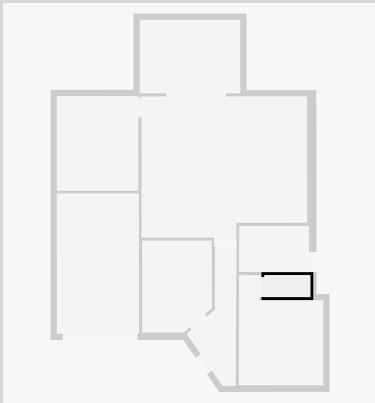

Bathroom

Width: 1.85 m
Length: 2.80 m
Area: 5.18 m²
Perimeter: 9.30 m

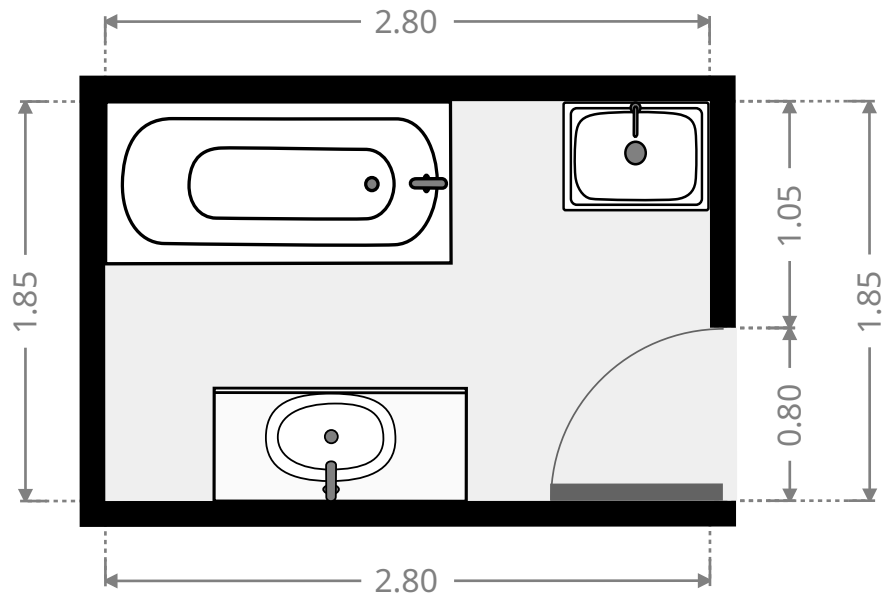
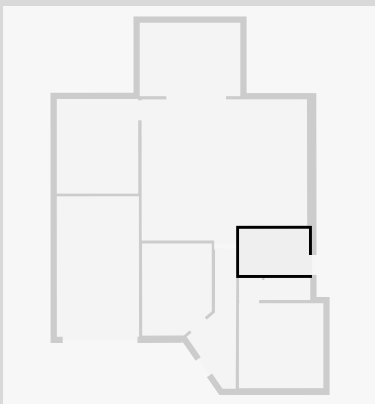

THIS FLOORPLAN IS PROVIDED WITHOUT WARRANTY OF ANY KIND. SENSOPIA DISCLAIMS ANY WARRANTY INCLUDING, WITHOUT LIMITATION, SATISFACTORY QUALITY OR ACCURACY OF DIMENSIONS.

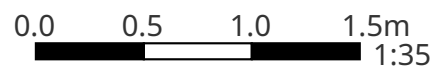

3/10 Hassell Street

Kitchen

Width: 5.67 m
 Length: 6.65 m
 Area: 35.95 m²
 Perimeter: 24.62 m

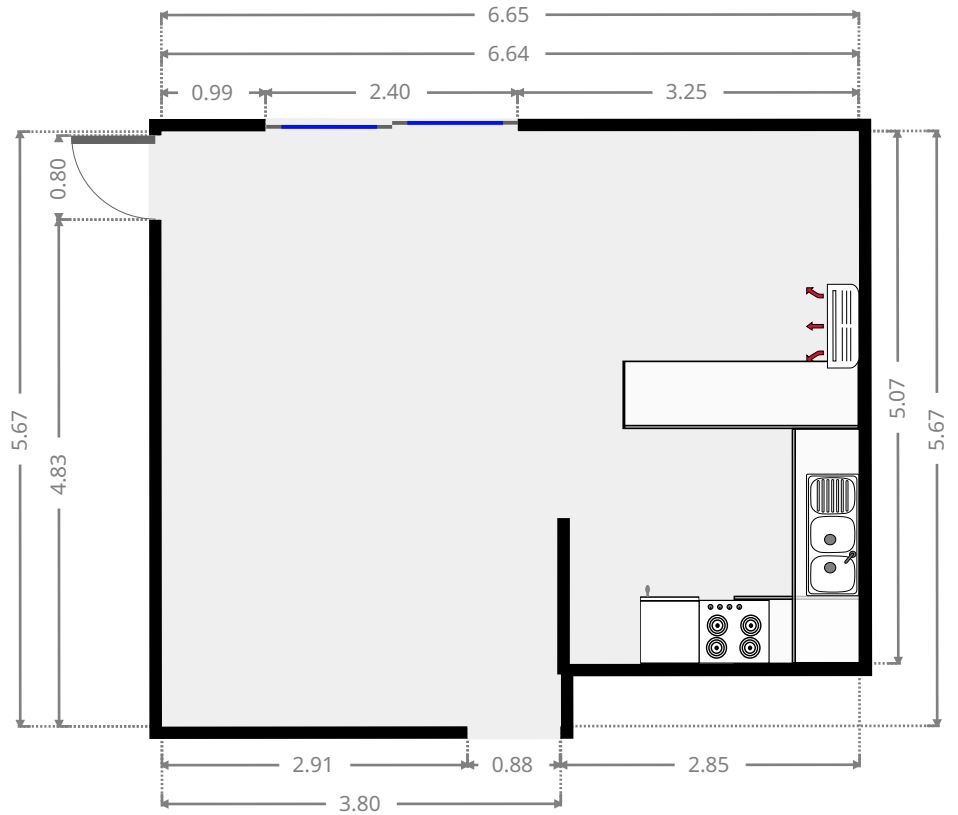
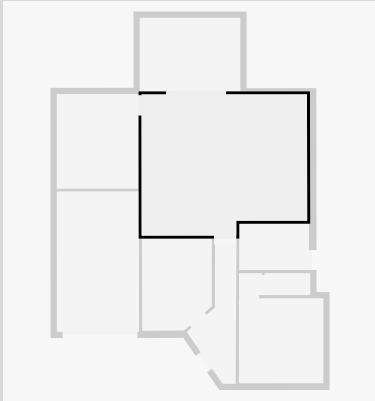

Bedroom

Width: 3.27 m
 Length: 3.80 m
 Area: 12.42 m²
 Perimeter: 14.14 m

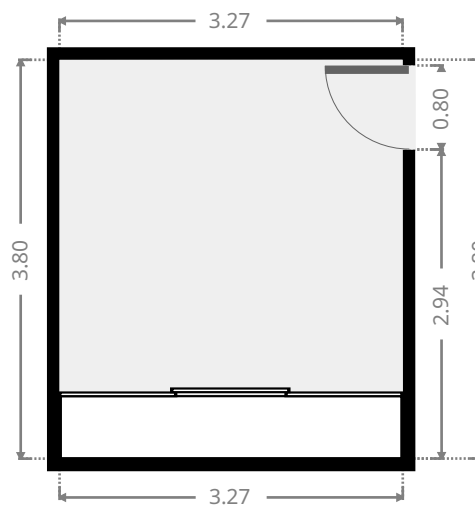
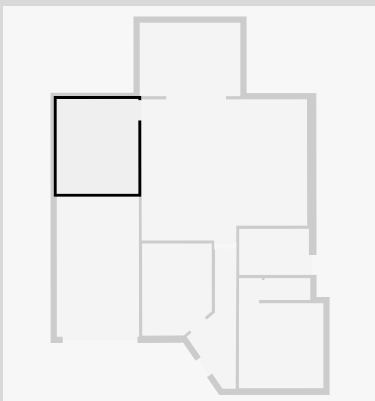

THIS FLOORPLAN IS PROVIDED WITHOUT WARRANTY OF ANY KIND. SENSOPIA DISCLAIMS ANY WARRANTY INCLUDING, WITHOUT LIMITATION, SATISFACTORY QUALITY OR ACCURACY OF DIMENSIONS.



3/10 Hassell Street

Other

Width: 2.95 m
Length: 4.04 m
Area: 11.92 m²
Perimeter: 13.98 m

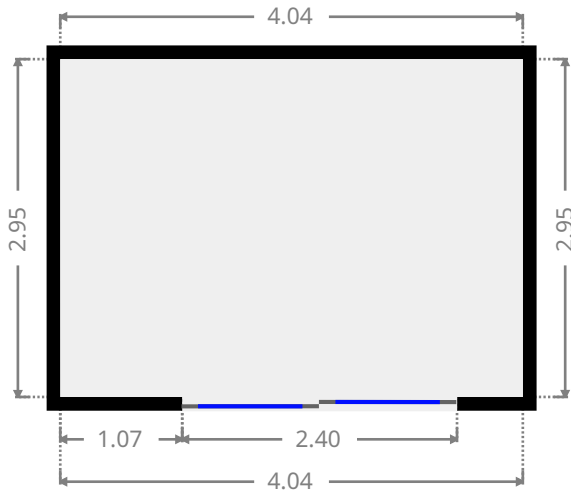
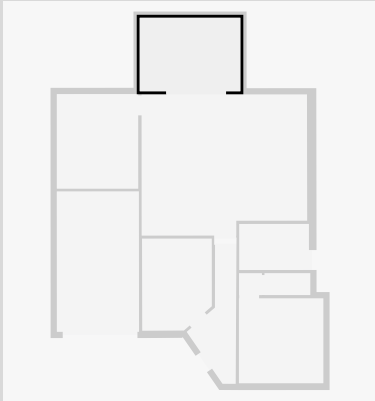

Garage

Width: 3.30 m
Length: 5.64 m
Area: 18.60 m²
Perimeter: 17.88 m

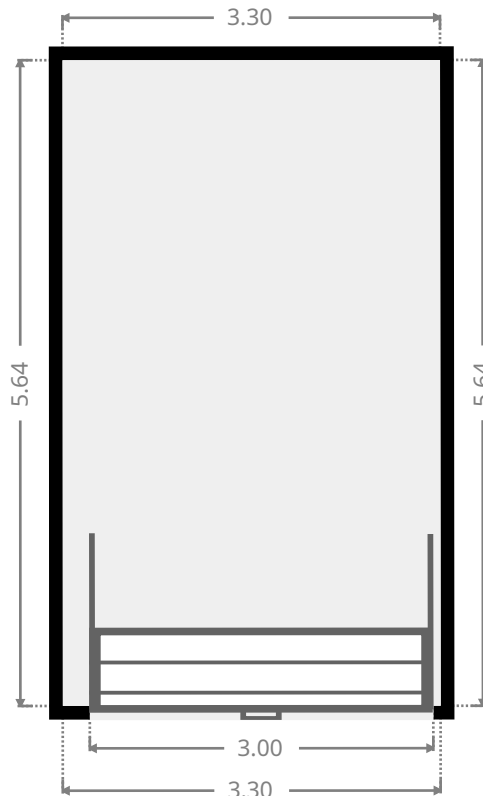
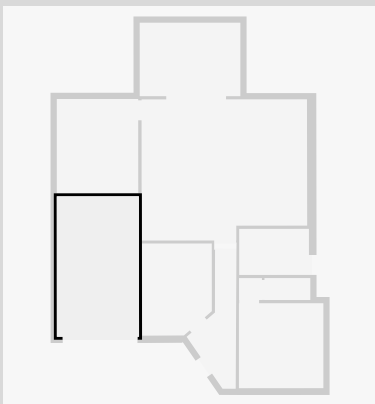

THIS FLOORPLAN IS PROVIDED WITHOUT WARRANTY OF ANY KIND. SENSOPIA DISCLAIMS ANY WARRANTY INCLUDING, WITHOUT LIMITATION, SATISFACTORY QUALITY OR ACCURACY OF DIMENSIONS.

