

29 Victoria Street

SUBMITTED BY
Ray White Rockhampton Casey
stockers@cqoz.com

CREATED ON
2022-04-20

Floors
2

▼ Ground Floor

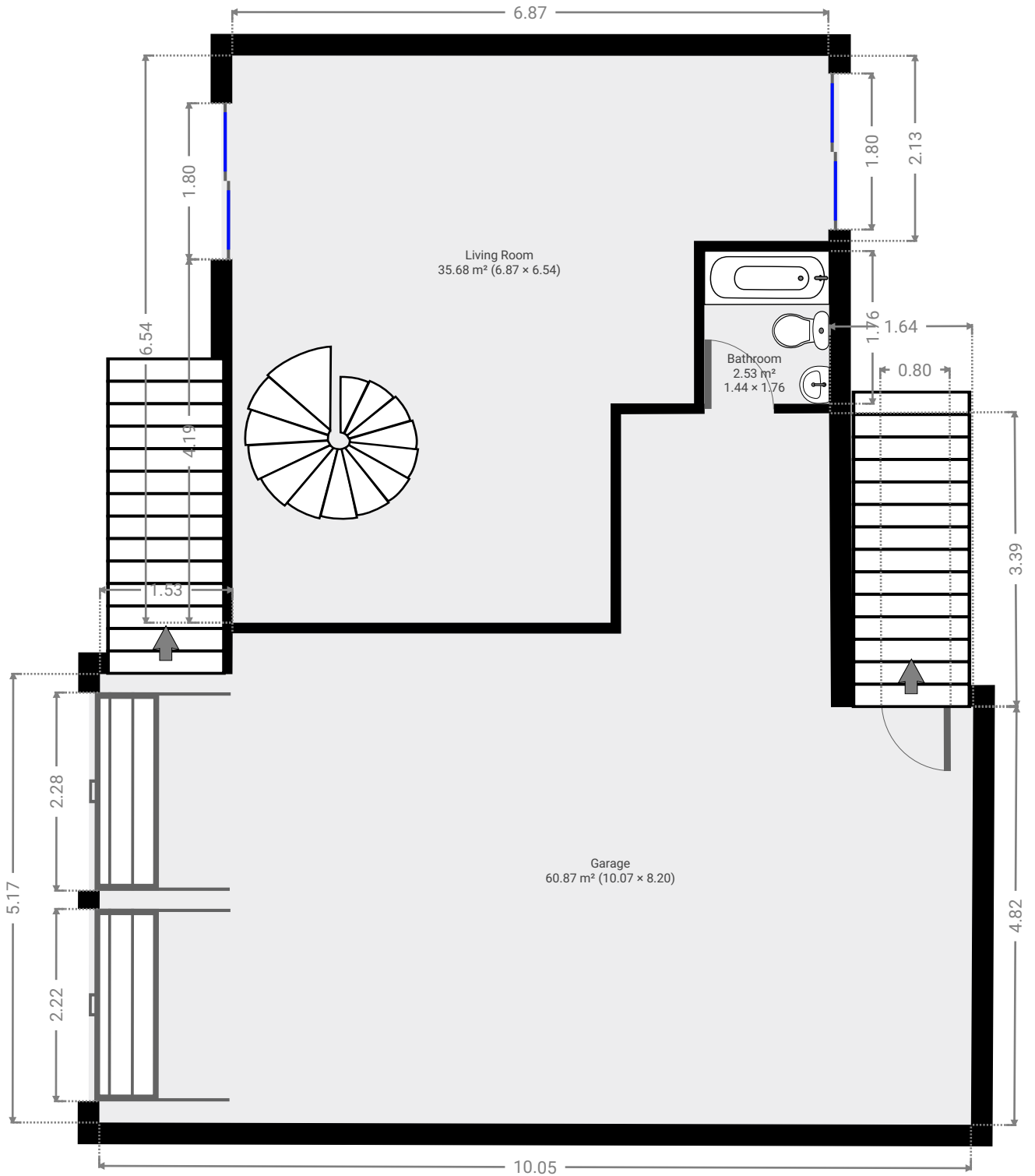

▼ **Garage**
Ground Floor

WIDTH: 8.18 m • LENGTH: 10.08 m
AREA: 60.87 m² • PERIMETER: 36.48 m

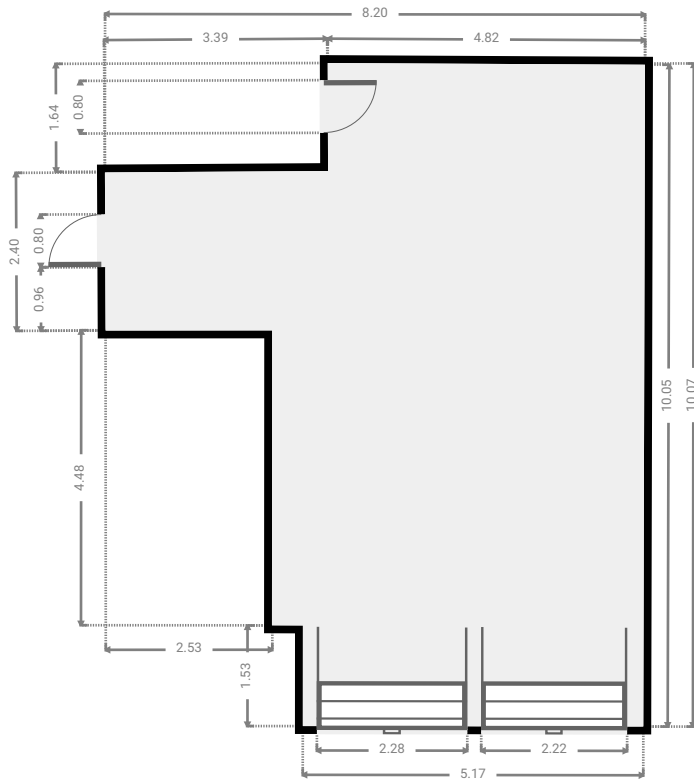
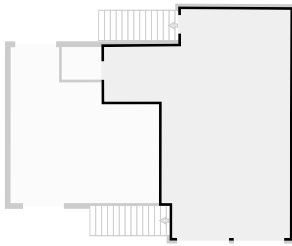

▼ **Bathroom**
Ground Floor

WIDTH: 1.76 m • LENGTH: 1.44 m
AREA: 2.53 m² • PERIMETER: 6.40 m

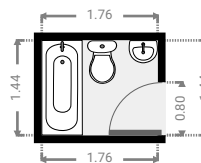

▼ **Living Room**
Ground Floor

WIDTH: 6.54 m • LENGTH: 6.87 m
AREA: 35.68 m² • PERIMETER: 26.82 m

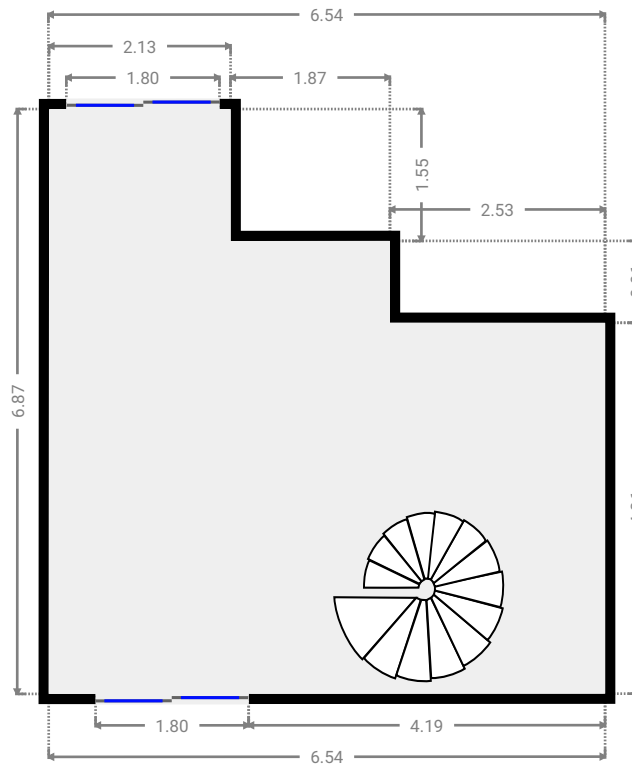
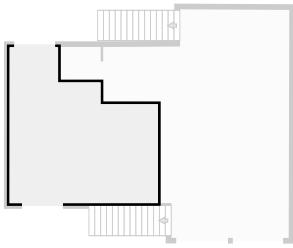

▼ 1st Floor

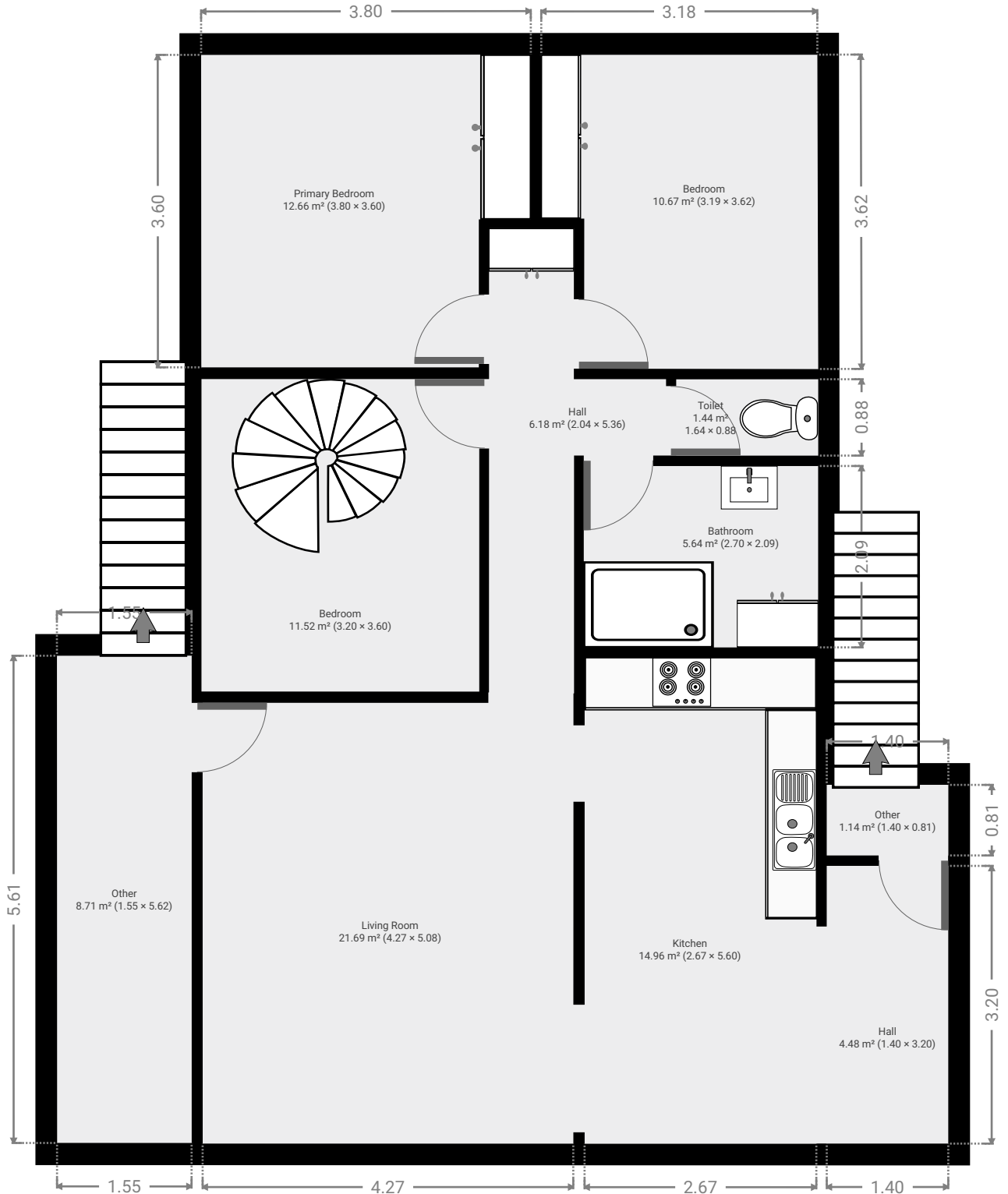

▼ **Living Room**
1st Floor

WIDTH: 5.08 m • LENGTH: 4.27 m
AREA: 21.69 m² • PERIMETER: 18.70 m

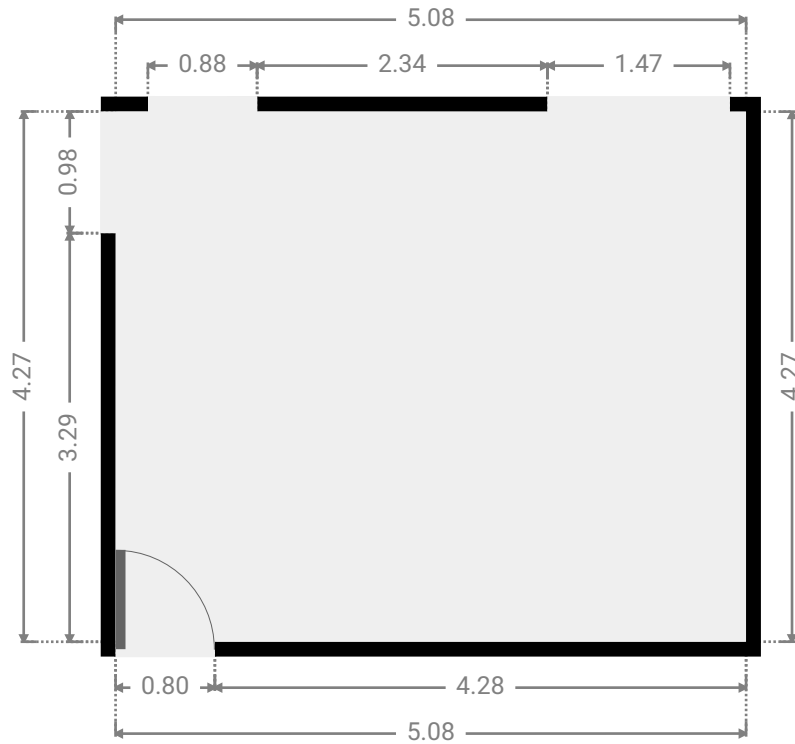
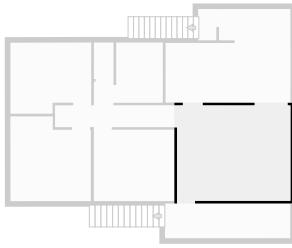

▼ **Kitchen**
1st Floor

WIDTH: 5.60 m • LENGTH: 2.67 m
AREA: 14.96 m² • PERIMETER: 16.54 m

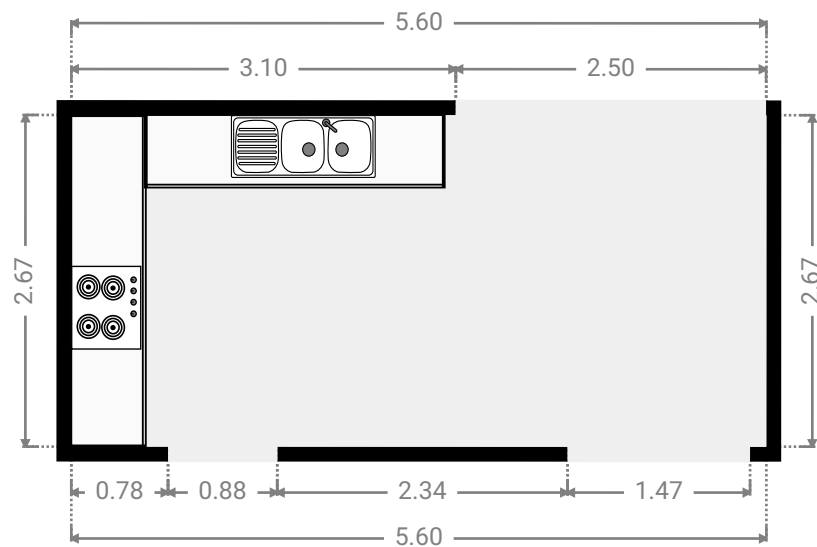
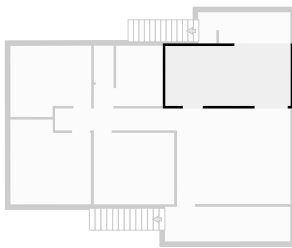

▼ **Hall**
1st Floor

WIDTH: 3.20 m • LENGTH: 1.40 m
AREA: 4.48 m² • PERIMETER: 9.20 m

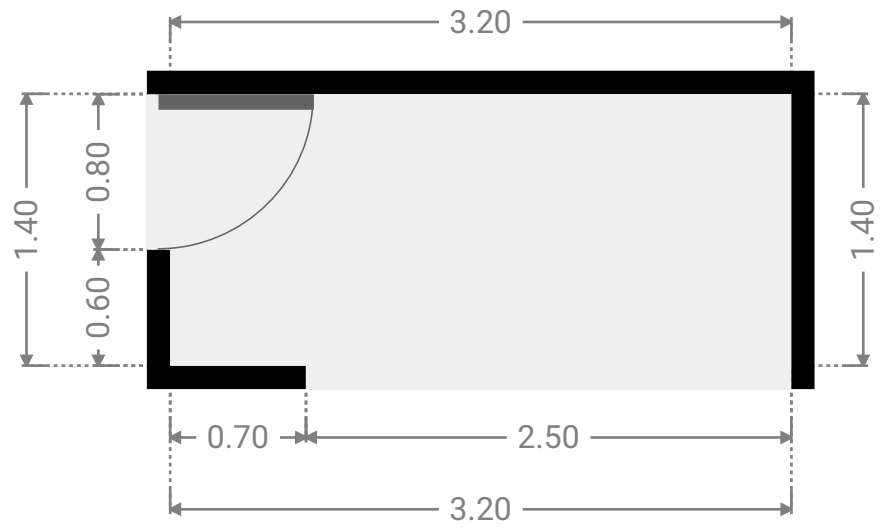
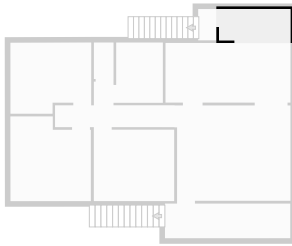

▼ **Other**
1st Floor

WIDTH: 0.81 m • LENGTH: 1.40 m
AREA: 1.14 m² • PERIMETER: 4.43 m

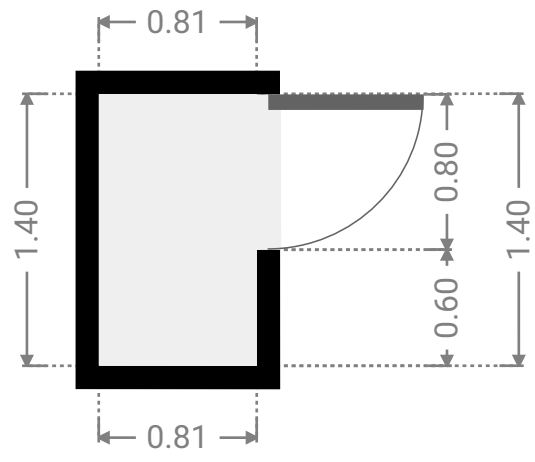
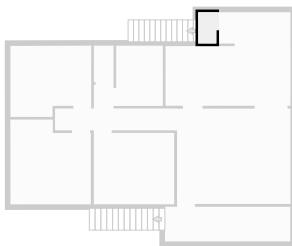

▼ **Hall**
1st Floor

WIDTH: 5.36 m • LENGTH: 2.04 m
AREA: 6.18 m² • PERIMETER: 14.80 m

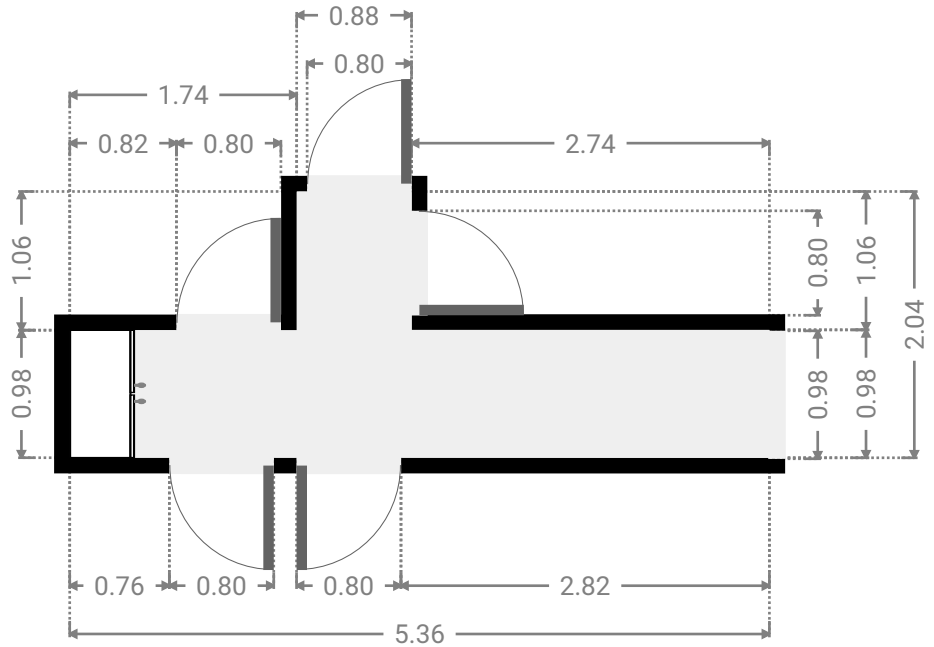
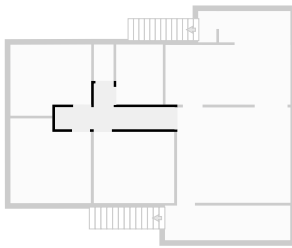

▼ **Bathroom**
1st Floor

WIDTH: 2.09 m • LENGTH: 2.70 m
AREA: 5.64 m² • PERIMETER: 9.58 m

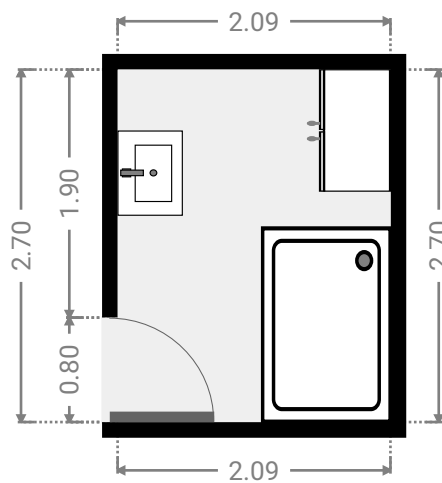
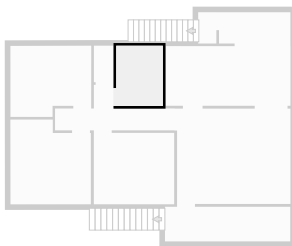

▼ **Toilet**
1st Floor

WIDTH: 0.88 m • LENGTH: 1.64 m
AREA: 1.44 m² • PERIMETER: 5.03 m

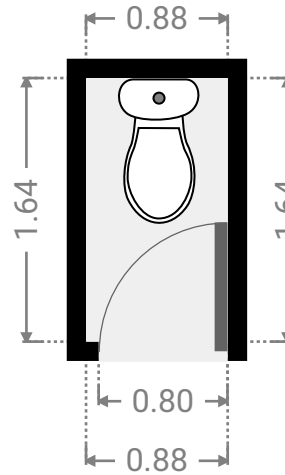
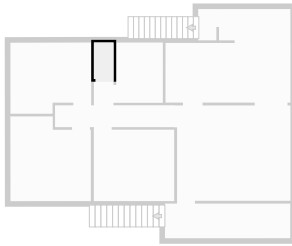

▼ **Bedroom**
1st Floor

WIDTH: 3.60 m • LENGTH: 3.20 m
AREA: 11.52 m² • PERIMETER: 13.60 m

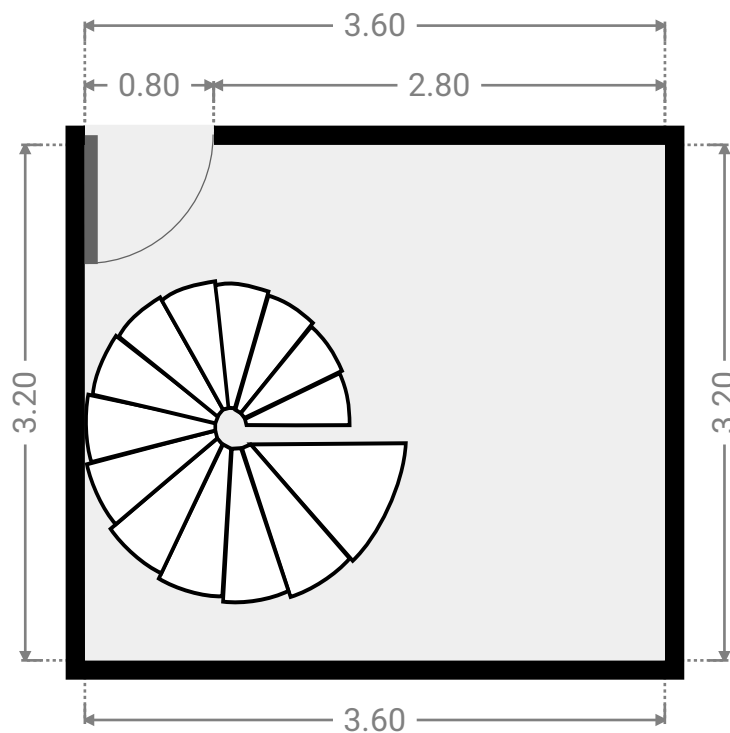
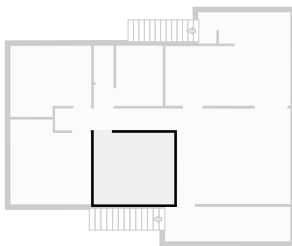

▼ **Primary Bedroom**
1st Floor

WIDTH: 3.60 m • LENGTH: 3.80 m
AREA: 12.66 m² • PERIMETER: 14.80 m

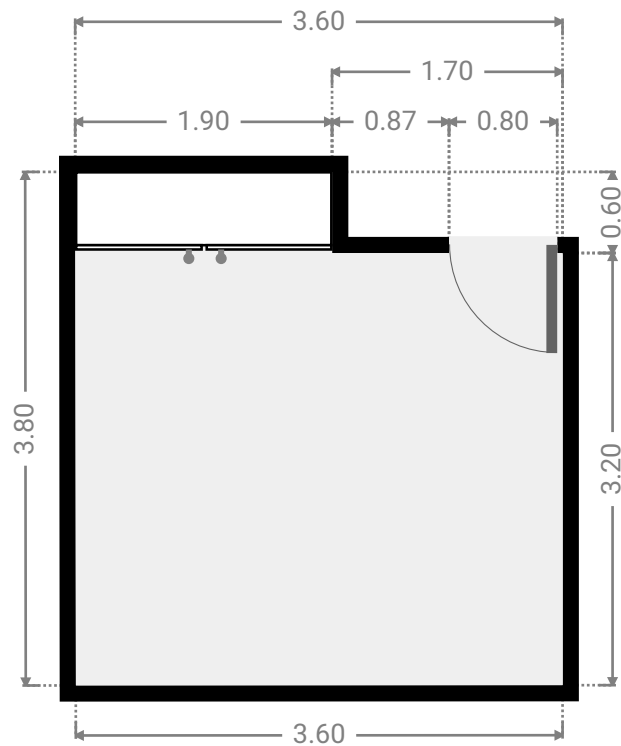
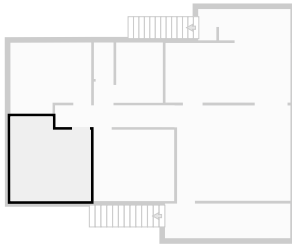

▼ **Bedroom**
1st Floor

WIDTH: 3.62 m • LENGTH: 3.19 m
AREA: 10.67 m² • PERIMETER: 13.61 m

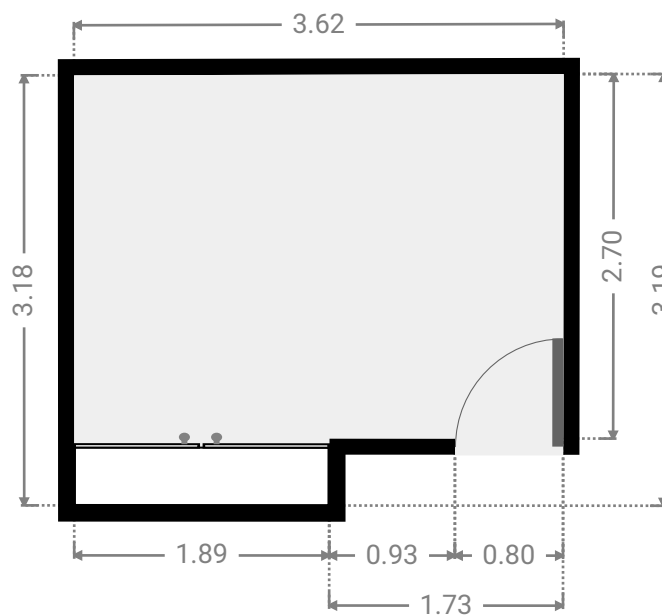
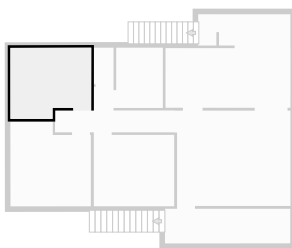

▼ Other
1st Floor

WIDTH: 5.62 m • LENGTH: 1.55 m
AREA: 8.71 m² • PERIMETER: 14.33 m

