

29 Belbowrie Court

Ground Floor

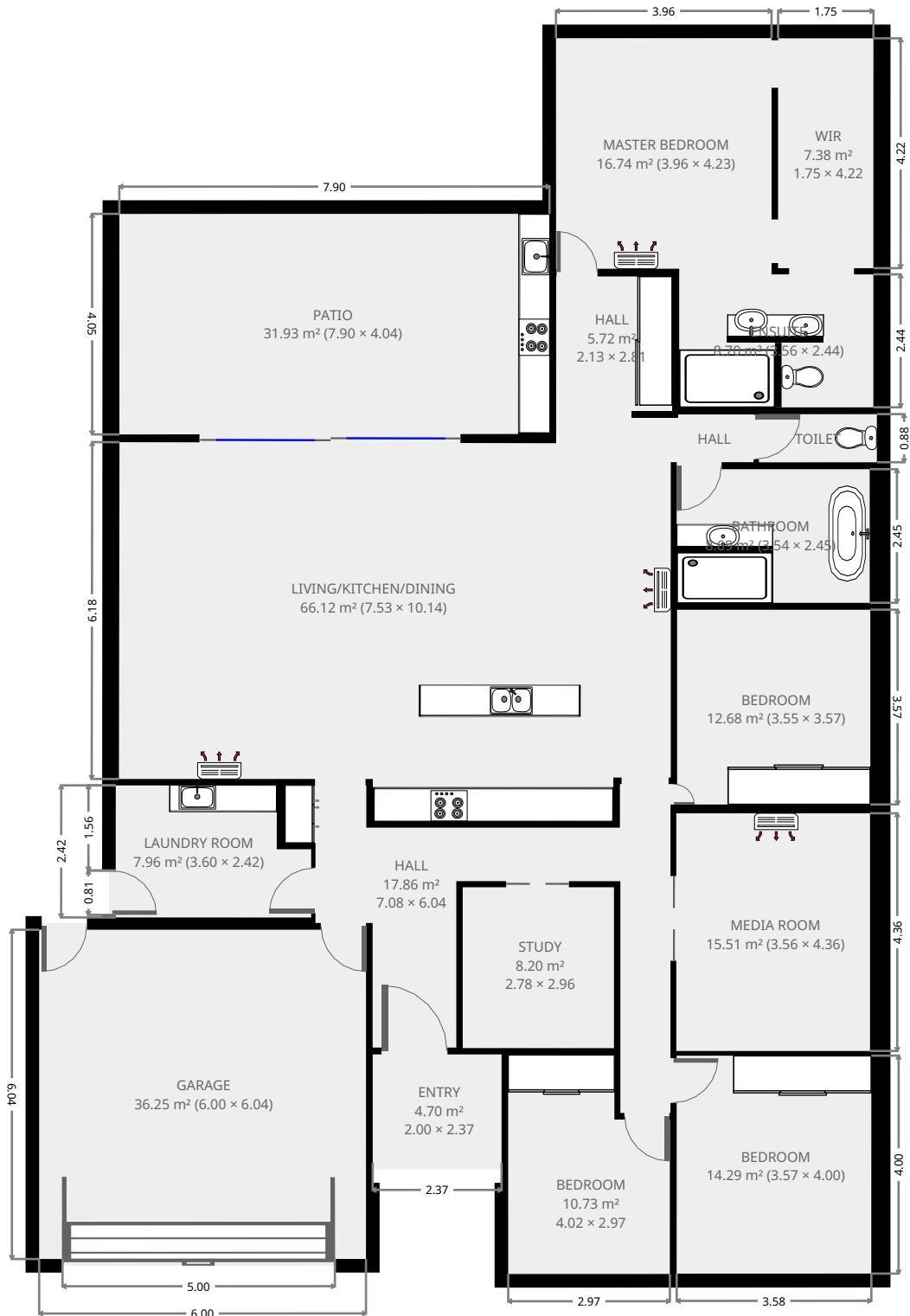

THIS FLOORPLAN IS PROVIDED WITHOUT WARRANTY OF ANY KIND. SENSOPIA DISCLAIMS ANY WARRANTY INCLUDING, WITHOUT LIMITATION, SATISFACTORY QUALITY OR ACCURACY OF DIMENSIONS.



29 Belbowrie Court

Bathroom

Width: 2.45 m
Length: 3.54 m
Area: 8.69 m²
Perimeter: 11.99 m

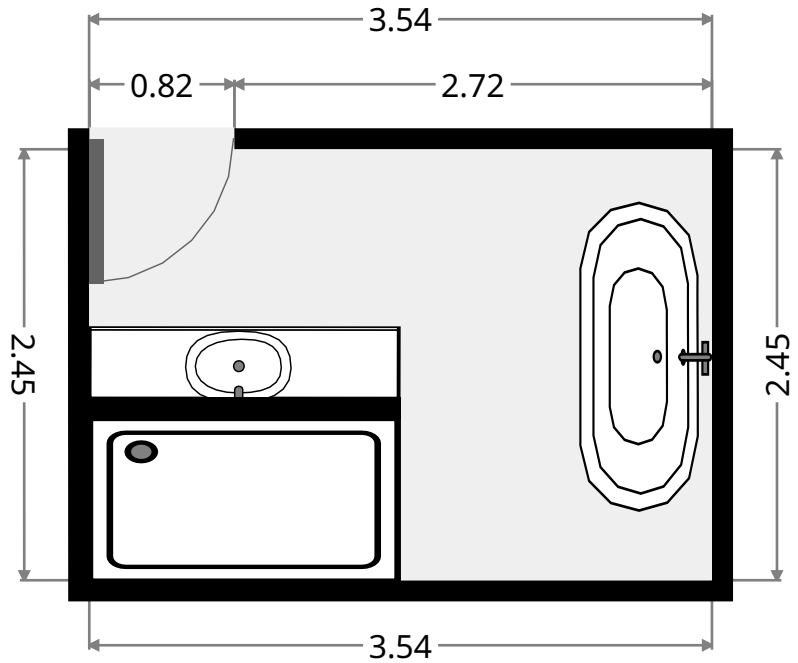
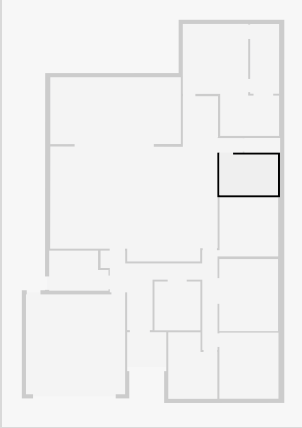

Entry

Width: 2.00 m
Length: 2.37 m
Area: 4.70 m²
Perimeter: 8.70 m

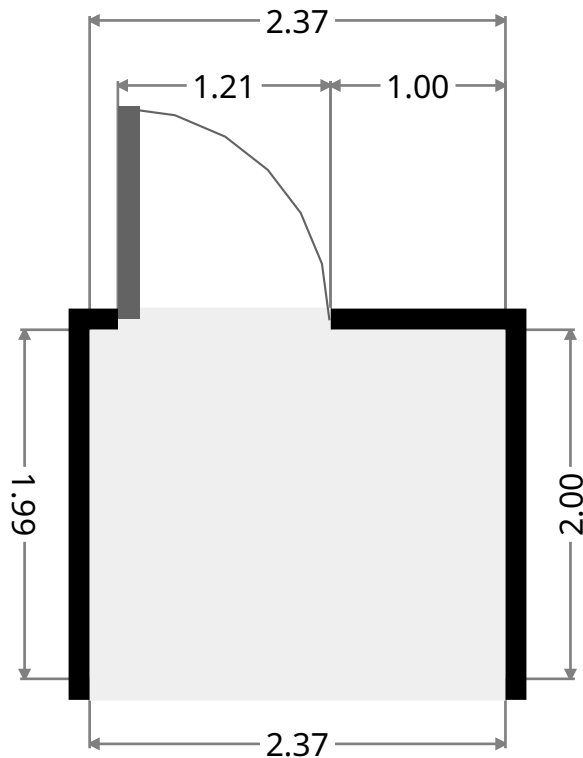
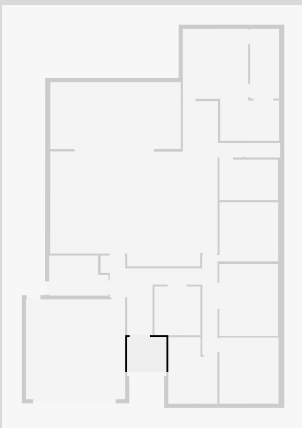

29 Belbowrie Court

Garage

Width: 6.00 m
Length: 6.04 m
Area: 36.25 m²
Perimeter: 24.08 m

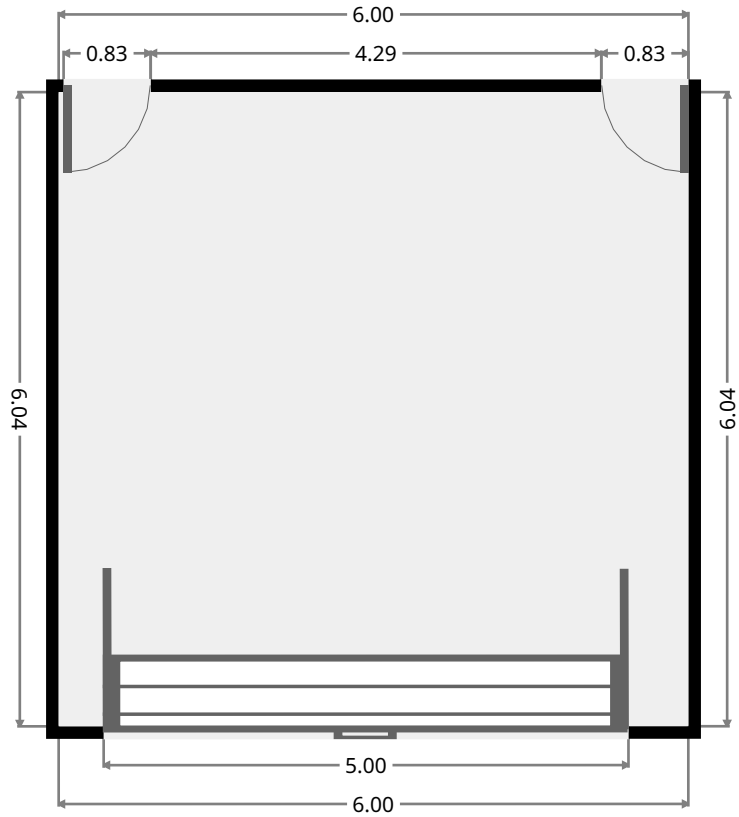
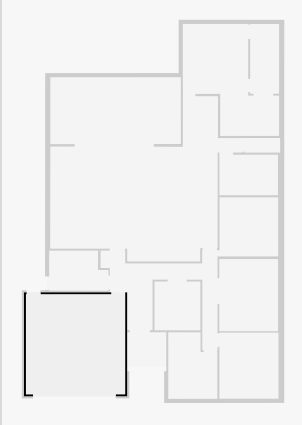

Laundry Room

Width: 2.42 m
Length: 3.60 m
Area: 7.96 m²
Perimeter: 12.02 m

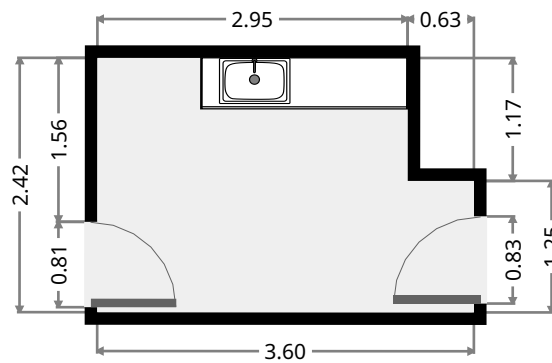
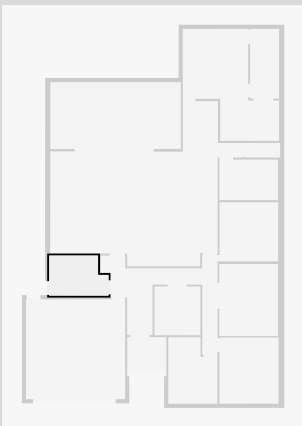

29 Belbowrie Court

Patio

Width: 4.04 m
Length: 7.90 m
Area: 31.93 m²
Perimeter: 23.88 m

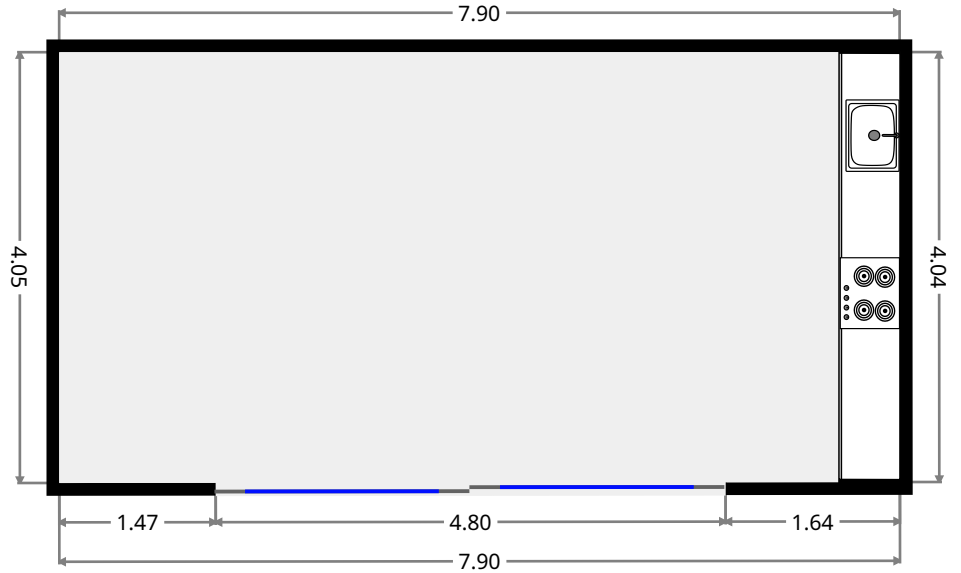
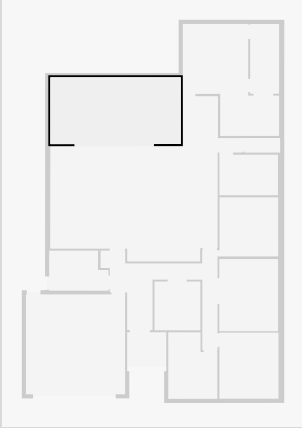

Hall

Width: 2.13 m
Length: 2.81 m
Area: 5.72 m²
Perimeter: 9.90 m

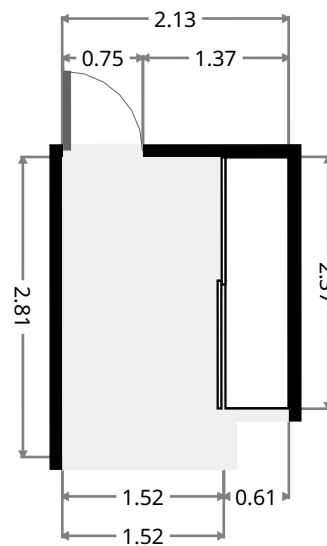
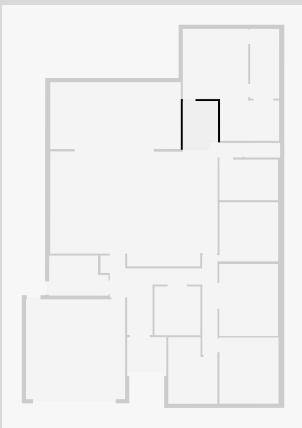

THIS FLOORPLAN IS PROVIDED WITHOUT WARRANTY OF ANY KIND. SENSOPIA DISCLAIMS ANY WARRANTY INCLUDING, WITHOUT LIMITATION, SATISFACTORY QUALITY OR ACCURACY OF DIMENSIONS.



29 Belbowrie Court

Ensuite

Width: 2.44 m
Length: 3.56 m
Area: 8.70 m²
Perimeter: 12.01 m

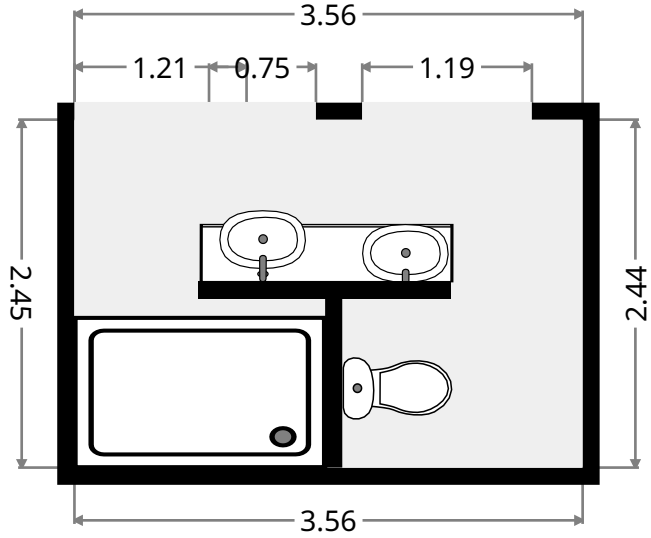
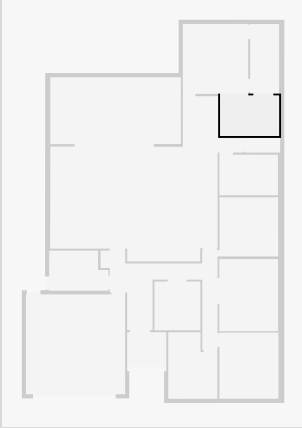

WIR

Width: 1.75 m
Length: 4.22 m
Area: 7.38 m²
Perimeter: 11.94 m

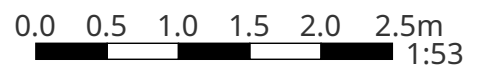
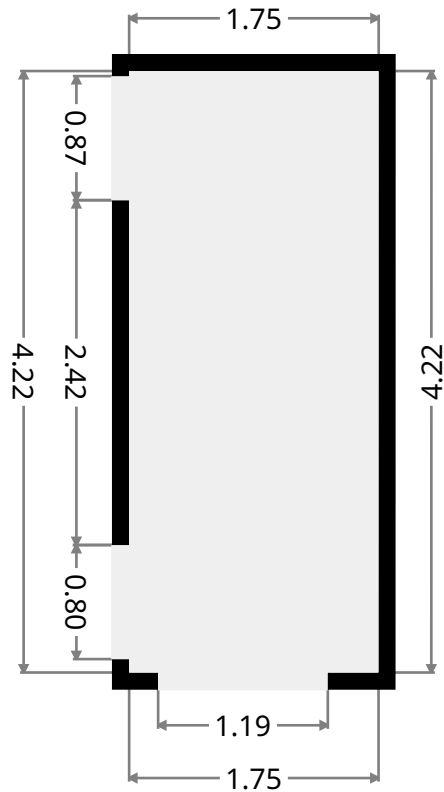
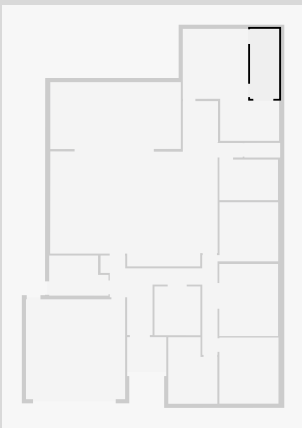

THIS FLOORPLAN IS PROVIDED WITHOUT WARRANTY OF ANY KIND. SENSOPIA DISCLAIMS ANY WARRANTY INCLUDING, WITHOUT LIMITATION, SATISFACTORY QUALITY OR ACCURACY OF DIMENSIONS.

29 Belbowrie Court

Toilet

Width: 0.88 m
Length: 2.16 m
Area: 1.91 m²
Perimeter: 6.09 m

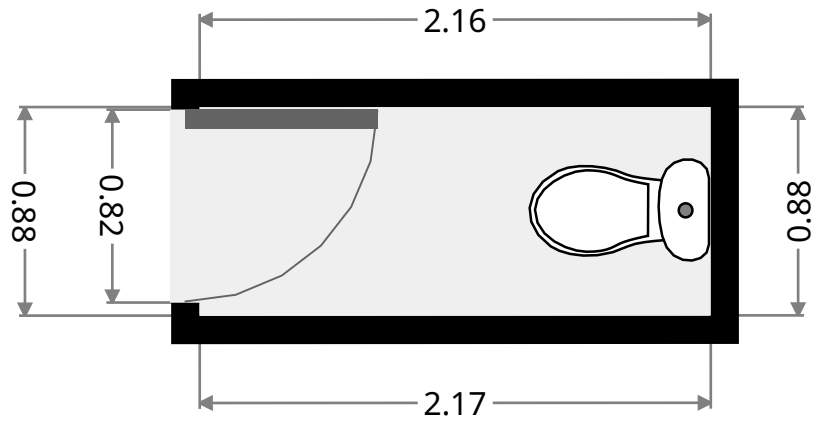
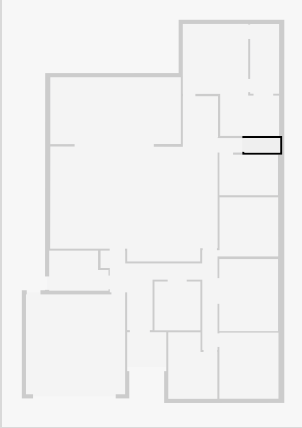

Hall

Width: 0.87 m
Length: 1.44 m
Area: 1.26 m²
Perimeter: 4.63 m

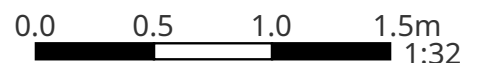
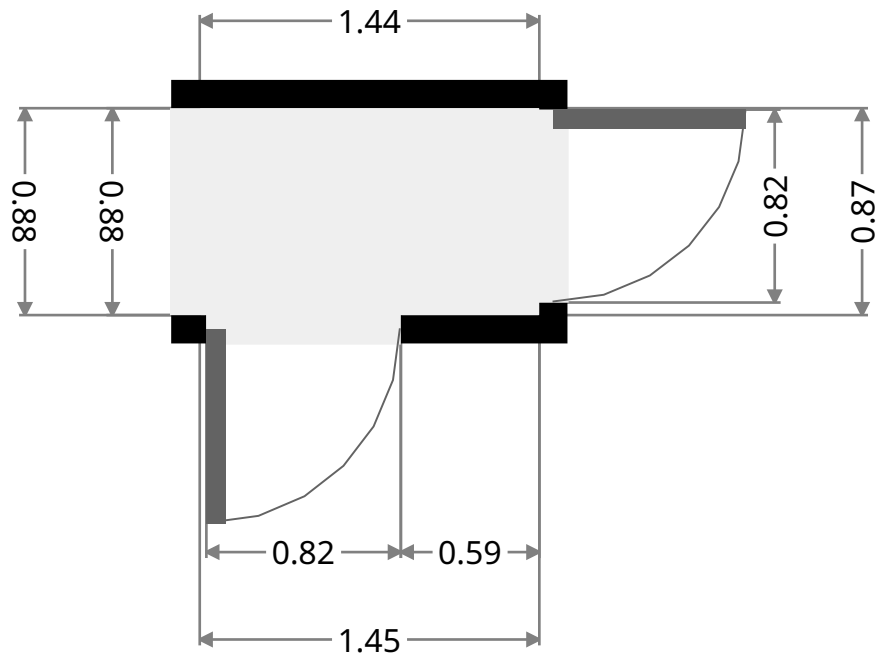
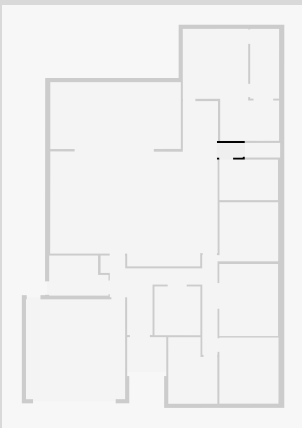

29 Belbowrie Court

Bedroom

Width: 3.55 m
 Length: 3.57 m
 Area: 12.68 m²
 Perimeter: 14.24 m

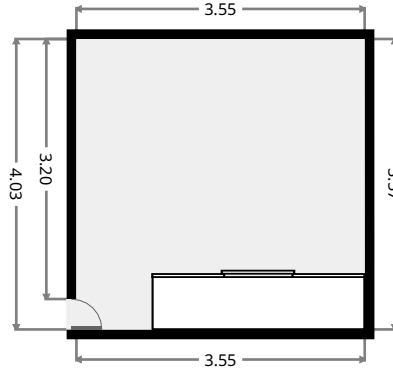
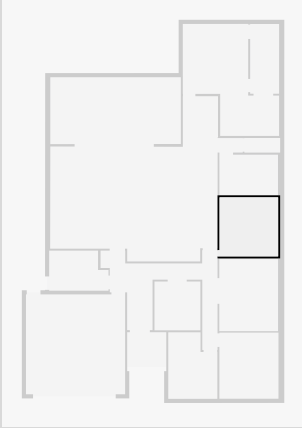

Living/Kitchen/Dining

Width: 7.53 m
 Length: 10.14 m
 Area: 66.12 m²
 Perimeter: 35.32 m

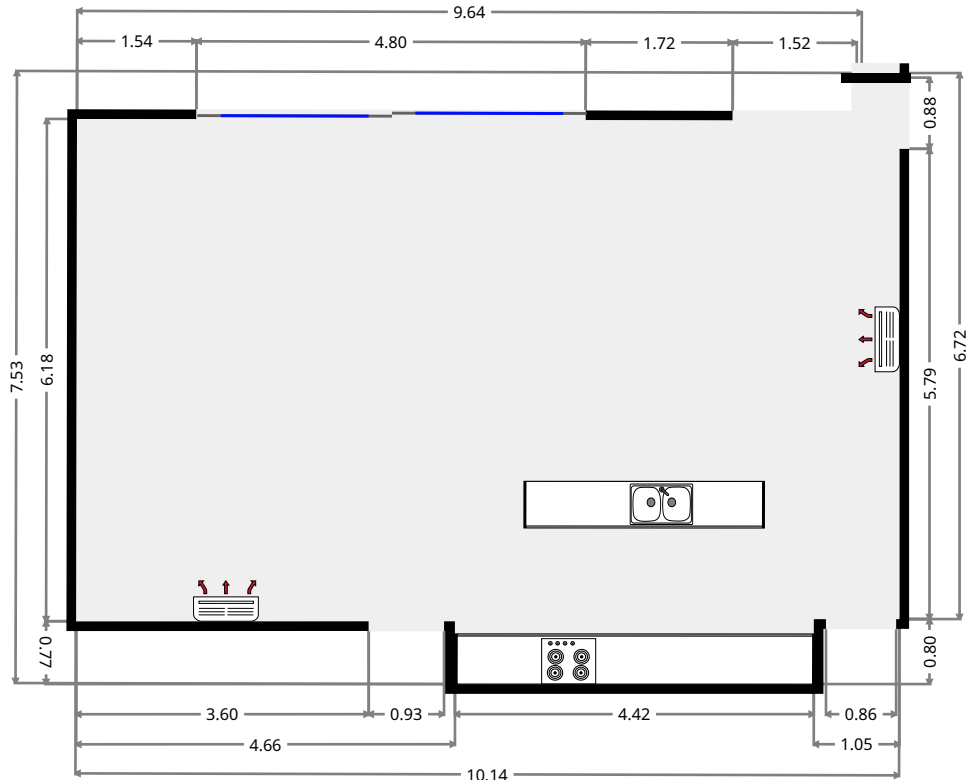
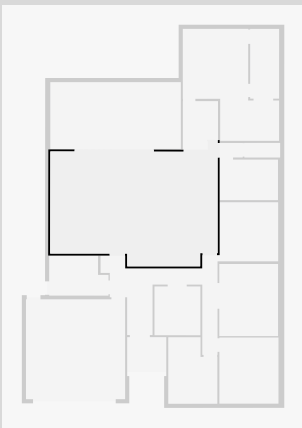

THIS FLOORPLAN IS PROVIDED WITHOUT WARRANTY OF ANY KIND. SENSOPIA DISCLAIMS ANY WARRANTY INCLUDING, WITHOUT LIMITATION, SATISFACTORY QUALITY OR ACCURACY OF DIMENSIONS.

29 Belbowrie Court

Bedroom

Width: 2.97 m
 Length: 4.02 m
 Area: 10.73 m²
 Perimeter: 13.99 m

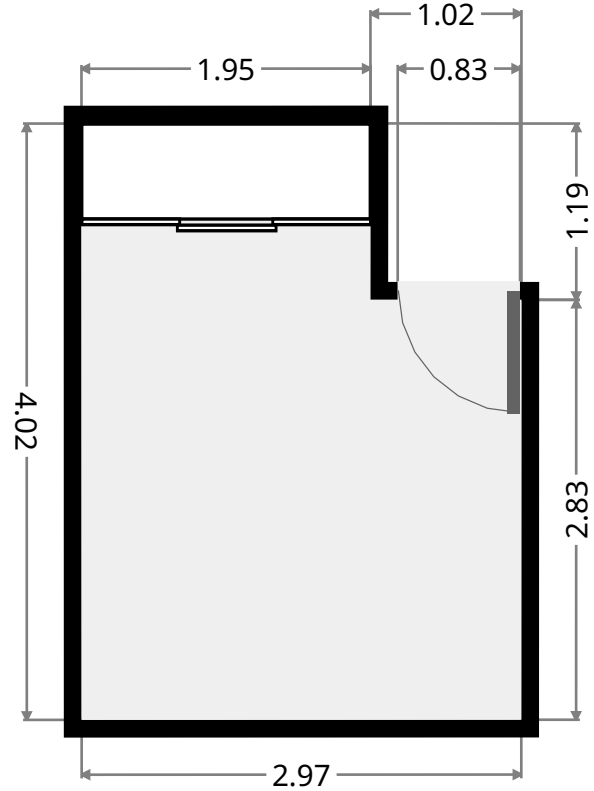

Bedroom

Width: 3.57 m
 Length: 4.00 m
 Area: 14.29 m²
 Perimeter: 15.14 m

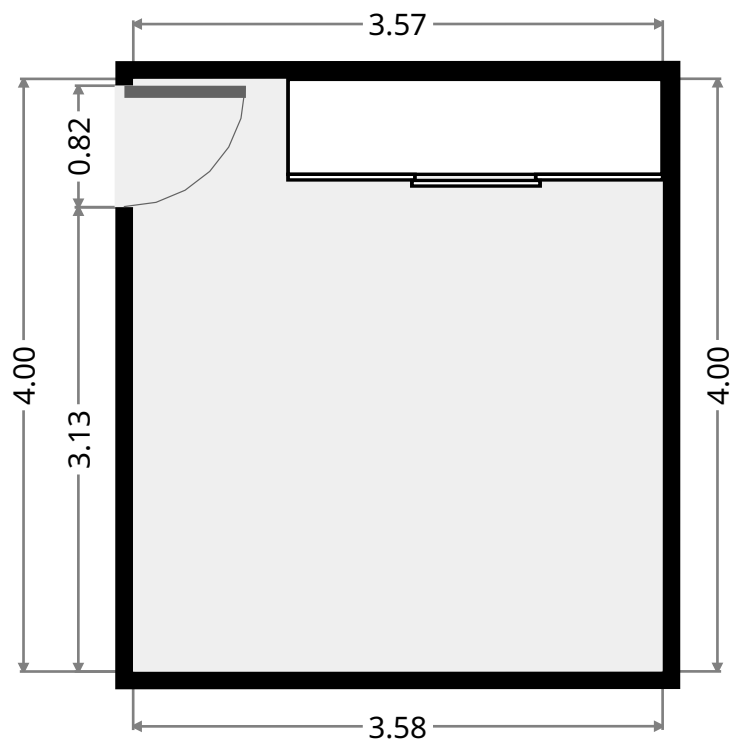
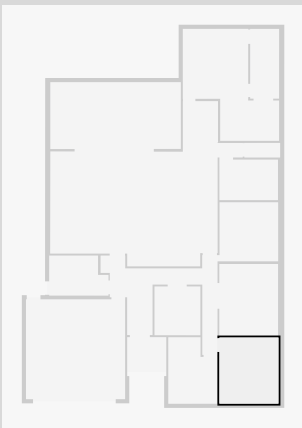

29 Belbowrie Court

Media Room

Width: 3.56 m
Length: 4.36 m
Area: 15.51 m²
Perimeter: 15.84 m

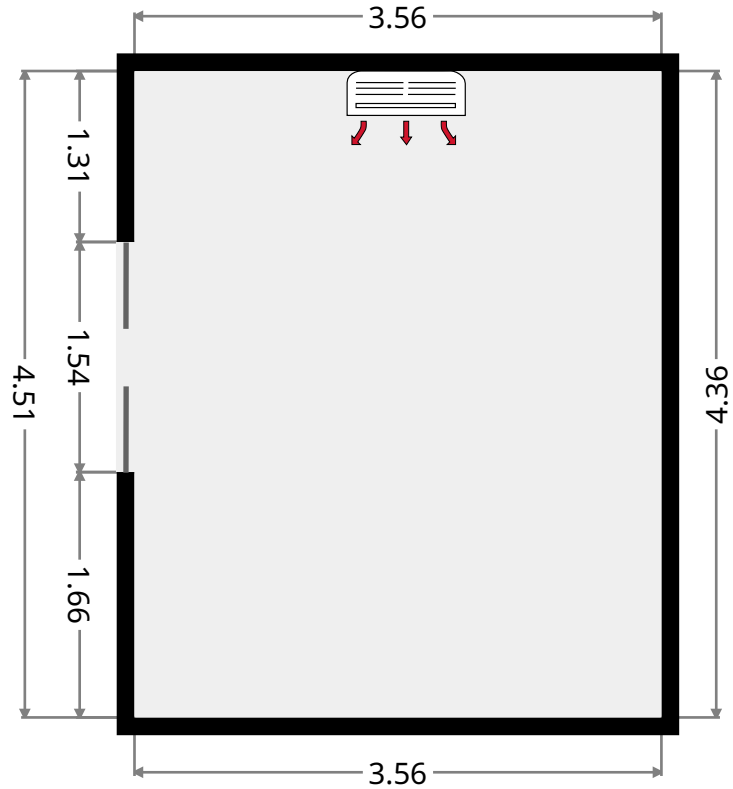
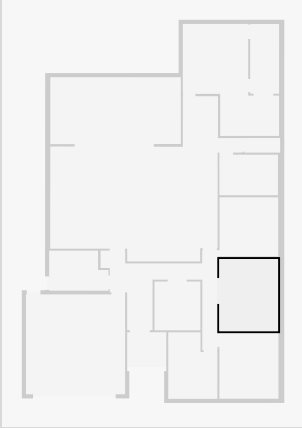

Study

Width: 2.78 m
Length: 2.96 m
Area: 8.20 m²
Perimeter: 11.46 m

