

# 289 Thirkettle Street

**SUBMITTED BY**  
Ray White Rockhampton Casey  
stockers@cqoz.com

---

**CREATED ON**  
2021-12-06

---

**Floors**  
2

---

▼ Ground Floor

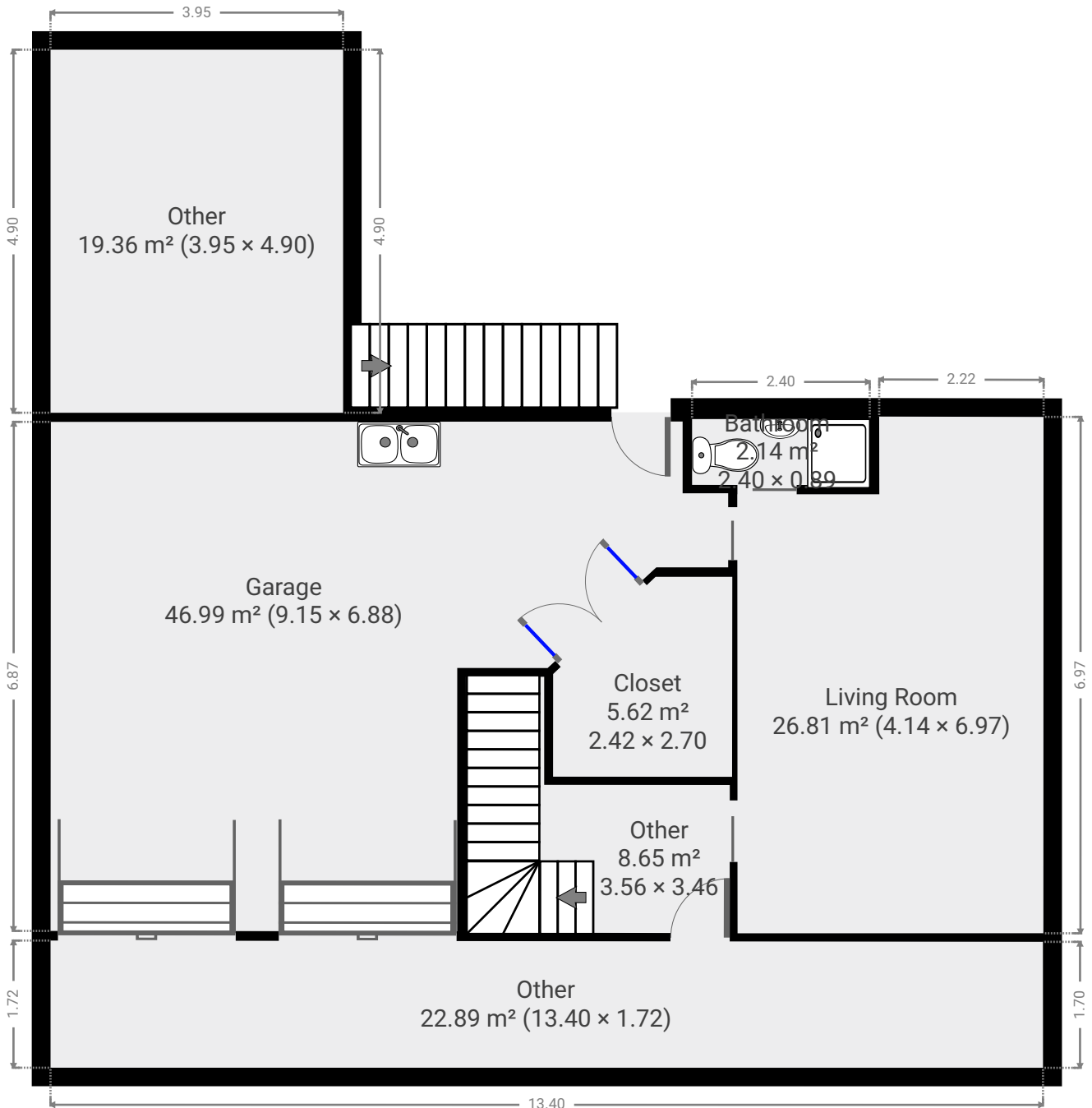

▼ **Living Room**  
Ground Floor

WIDTH: 4.14 m • LENGTH: 6.97 m  
AREA: 26.81 m<sup>2</sup> • PERIMETER: 22.21 m

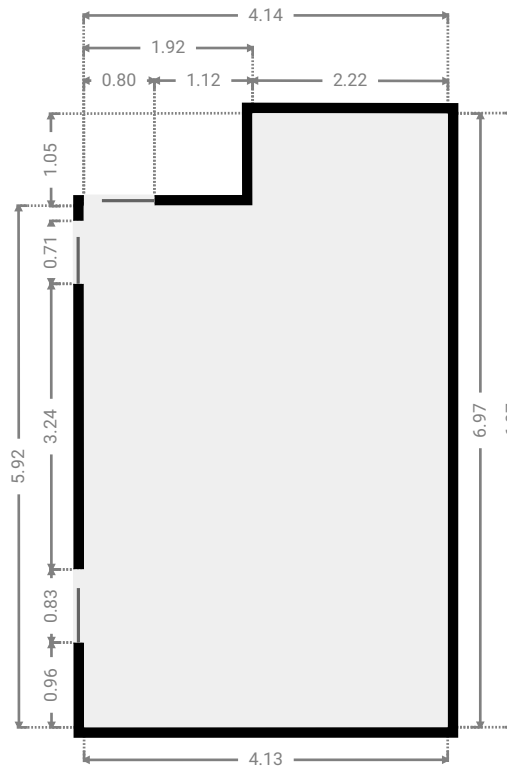
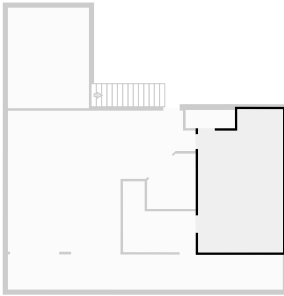

▼ **Bathroom**  
Ground Floor

WIDTH: 2.40 m • LENGTH: 0.89 m  
AREA: 2.14 m<sup>2</sup> • PERIMETER: 6.58 m

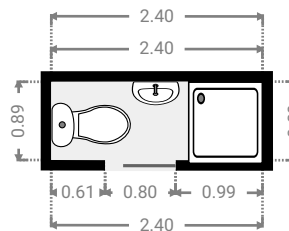
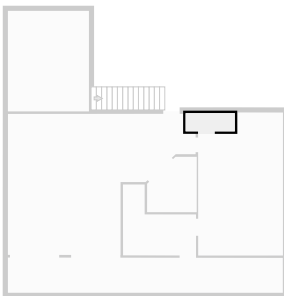

▼ **Garage**  
Ground Floor

WIDTH: 9.15 m • LENGTH: 6.88 m  
AREA: 46.99 m<sup>2</sup> • PERIMETER: 31.22 m

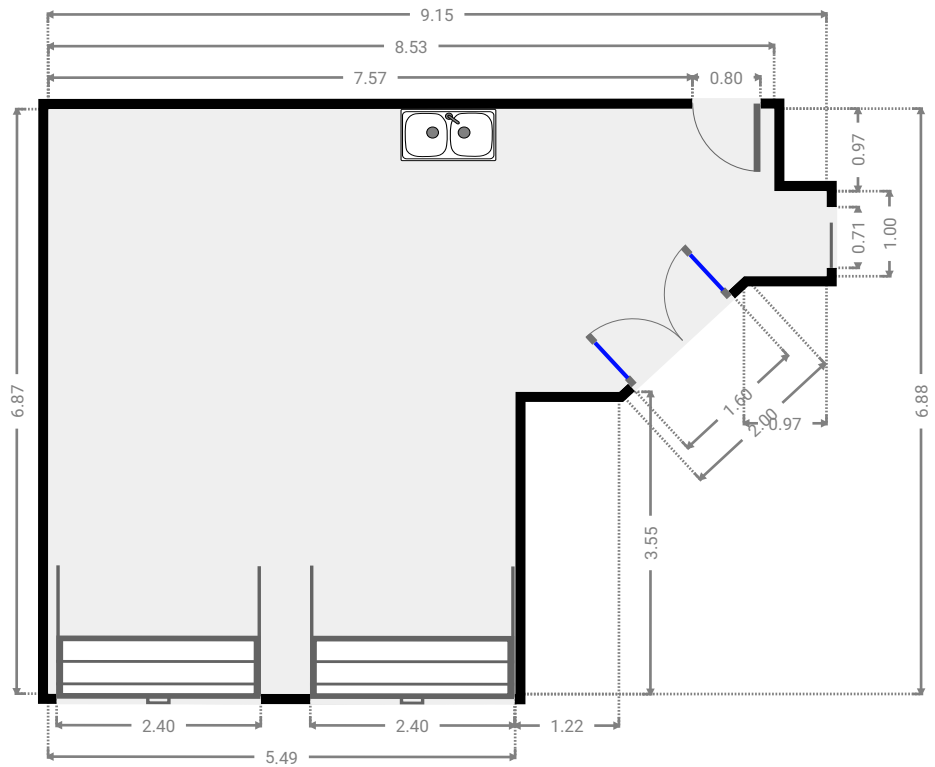
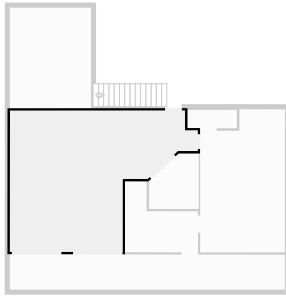

▼ **Closet**  
Ground Floor

WIDTH: 2.42 m • LENGTH: 2.70 m  
AREA: 5.62 m<sup>2</sup> • PERIMETER: 9.44 m

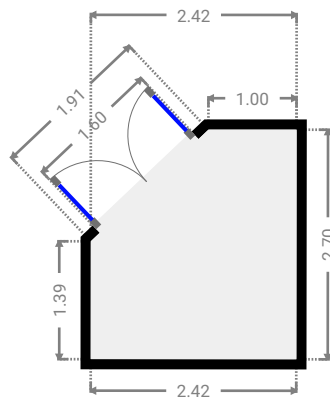
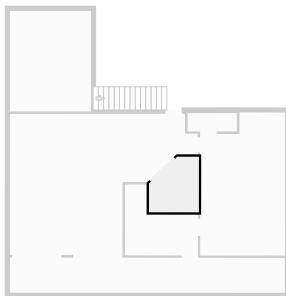

FLOORS: 2

▼ **Other**  
Ground Floor

WIDTH: 3.56 m • LENGTH: 3.46 m  
AREA: 8.65 m<sup>2</sup> • PERIMETER: 14.03 m

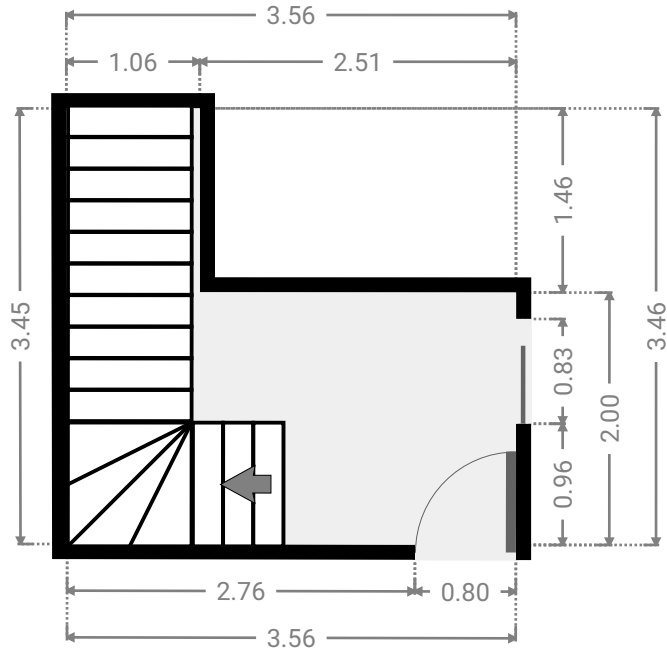
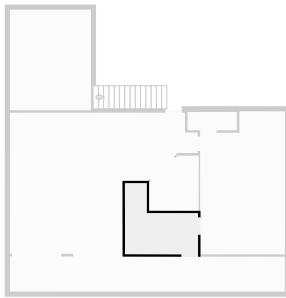

▼ **Other**  
Ground Floor

WIDTH: 3.95 m • LENGTH: 4.90 m  
AREA: 19.36 m<sup>2</sup> • PERIMETER: 17.70 m

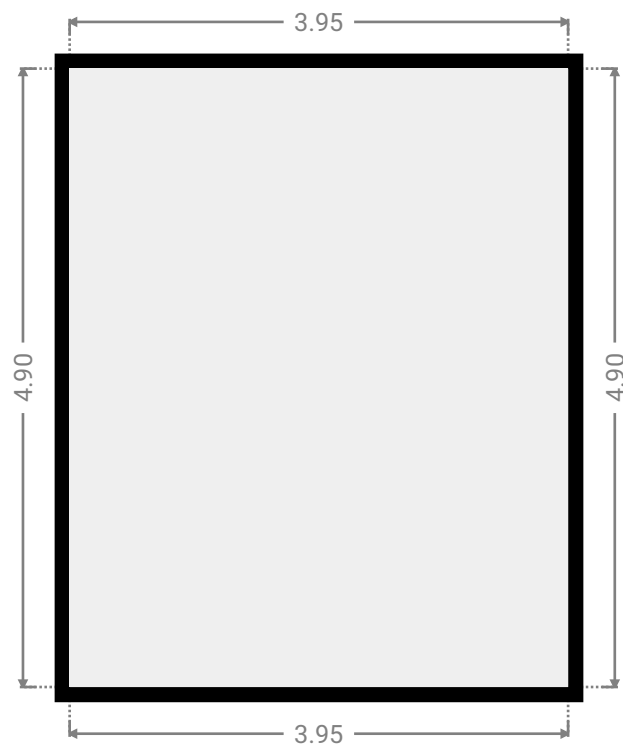
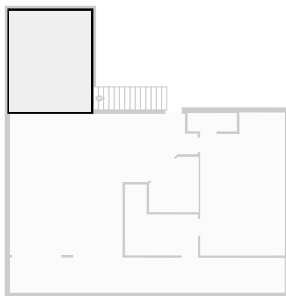

▼ Other  
Ground Floor

WIDTH: 13.40 m • LENGTH: 1.72 m  
AREA: 22.89 m<sup>2</sup> • PERIMETER: 30.22 m

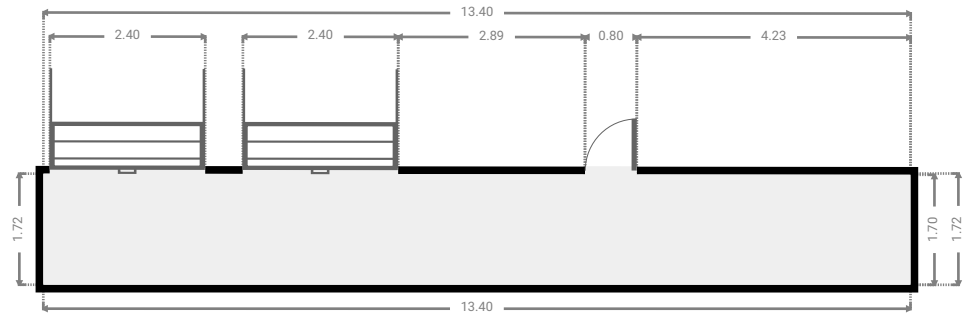
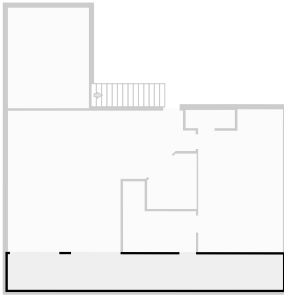

▼ 1st Floor

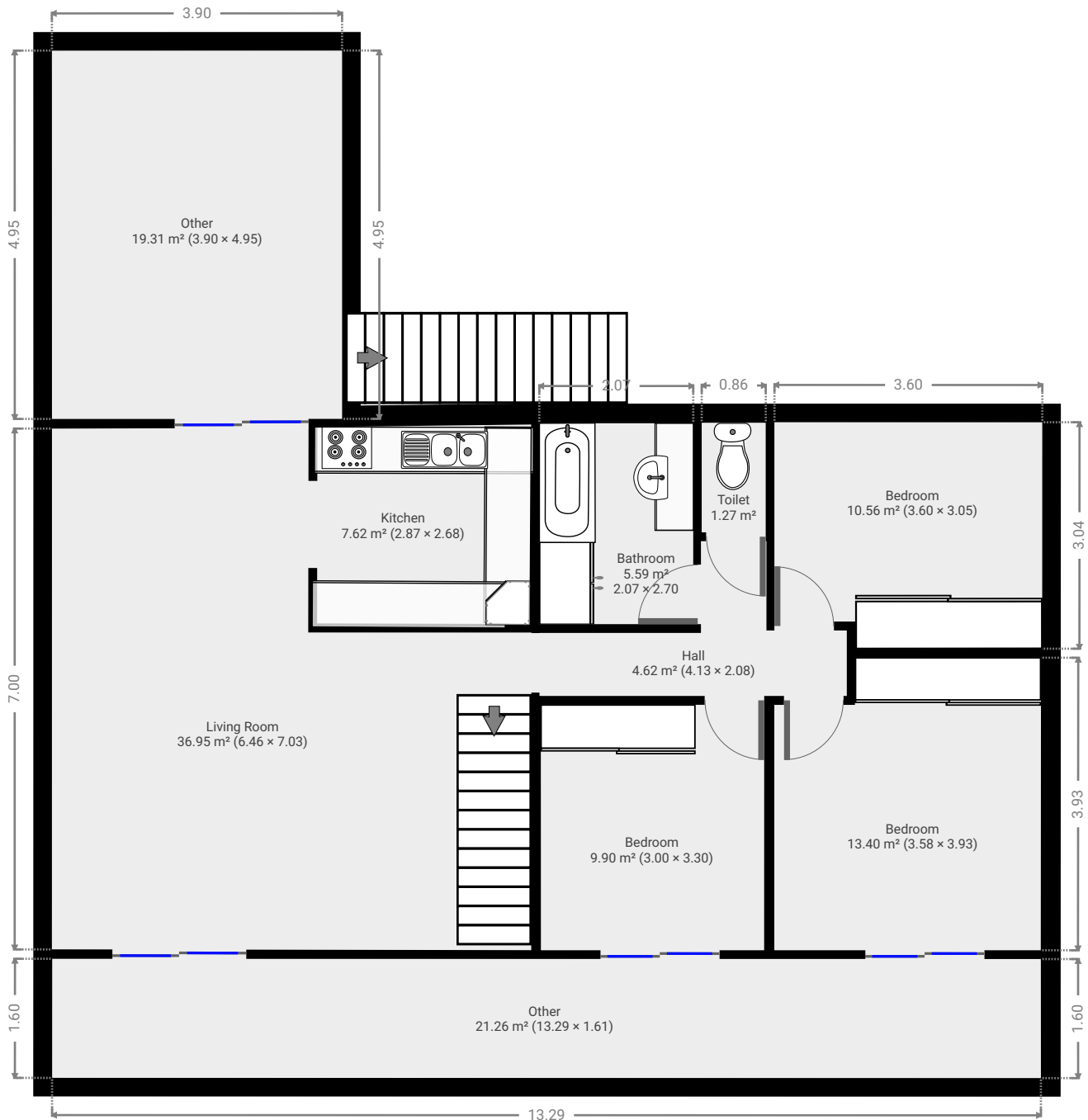

▼ Living Room  
1st Floor

WIDTH: 6.46 m • LENGTH: 7.03 m  
AREA: 36.95 m<sup>2</sup> • PERIMETER: 26.91 m

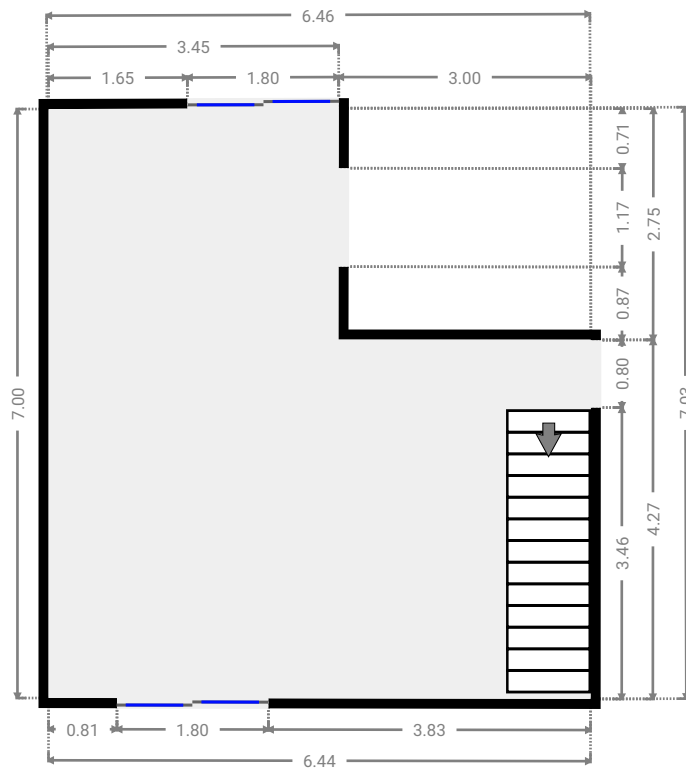
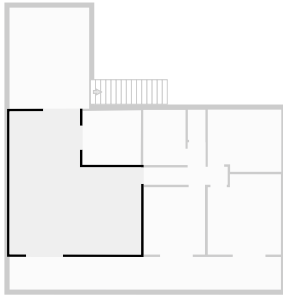

▼ Hall  
1st Floor

WIDTH: 4.13 m • LENGTH: 2.08 m  
AREA: 4.62 m<sup>2</sup> • PERIMETER: 12.42 m

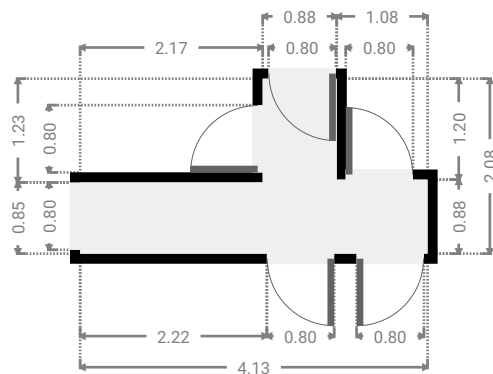
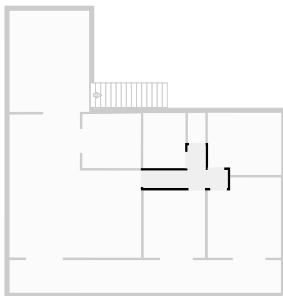



FLOORS: 2

▼ **Bedroom**  
1st Floor

WIDTH: 3.00 m • LENGTH: 3.30 m  
AREA: 9.90 m<sup>2</sup> • PERIMETER: 12.60 m

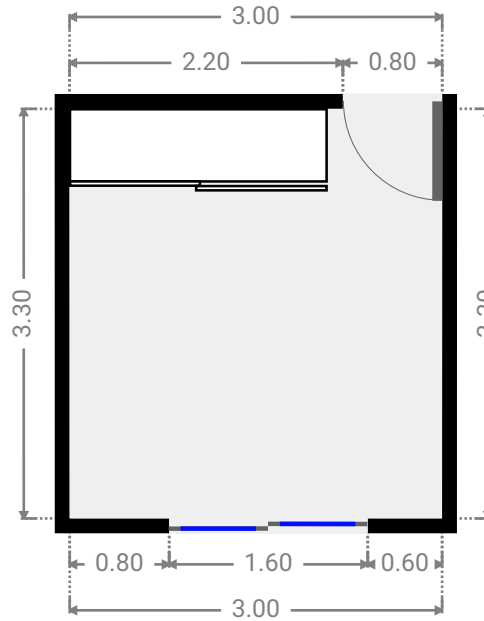
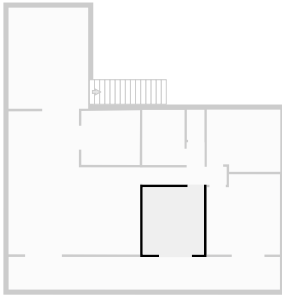

▼ **Bedroom**  
1st Floor

WIDTH: 3.58 m • LENGTH: 3.93 m  
AREA: 13.40 m<sup>2</sup> • PERIMETER: 15.03 m

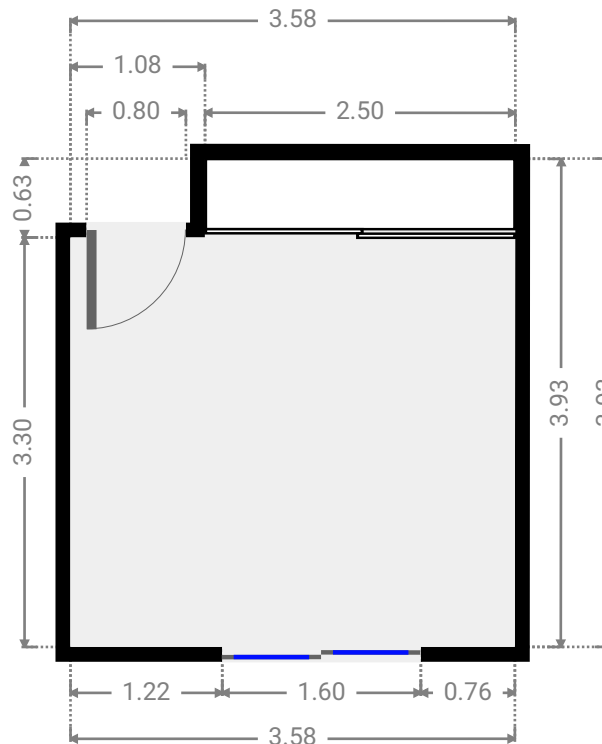
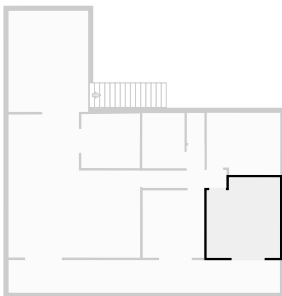

▼ **Bedroom**  
1st Floor

WIDTH: 3.60 m • LENGTH: 3.05 m  
AREA: 10.56 m<sup>2</sup> • PERIMETER: 13.29 m

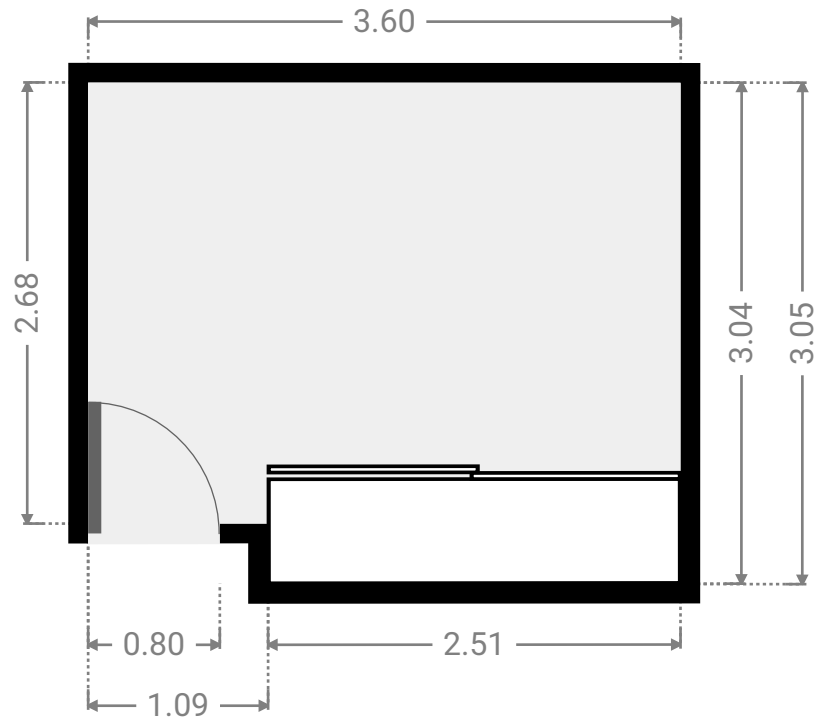
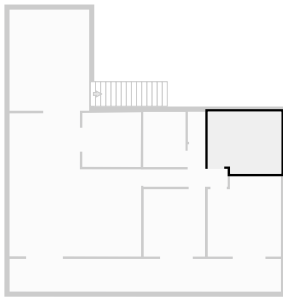

▼ **Toilet**  
1st Floor

WIDTH: 0.86 m • LENGTH: 1.47 m  
AREA: 1.27 m<sup>2</sup> • PERIMETER: 4.67 m

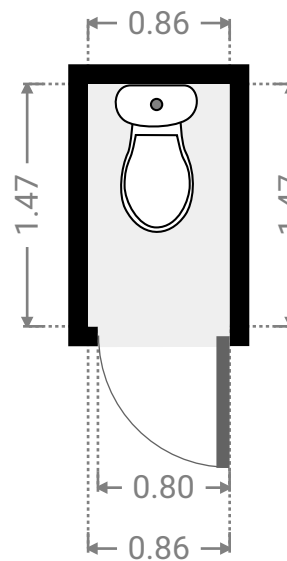
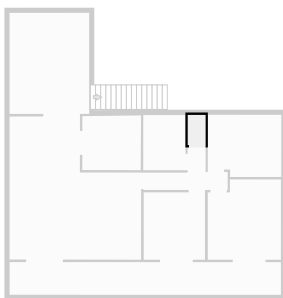

▼ **Bathroom**  
1st Floor

WIDTH: 2.07 m • LENGTH: 2.70 m  
AREA: 5.59 m<sup>2</sup> • PERIMETER: 9.54 m

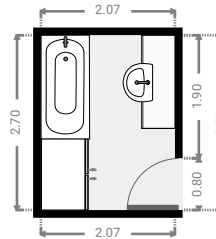
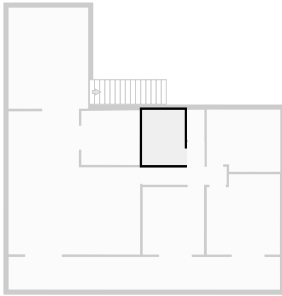

▼ **Other**  
1st Floor

WIDTH: 13.29 m • LENGTH: 1.61 m  
AREA: 21.26 m<sup>2</sup> • PERIMETER: 29.78 m

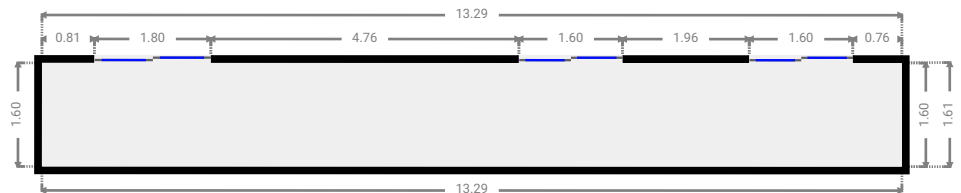
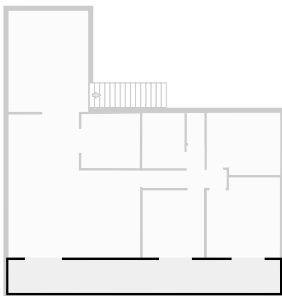

▼ **Kitchen**  
1st Floor

WIDTH: 2.87 m • LENGTH: 2.68 m  
AREA: 7.62 m<sup>2</sup> • PERIMETER: 11.05 m

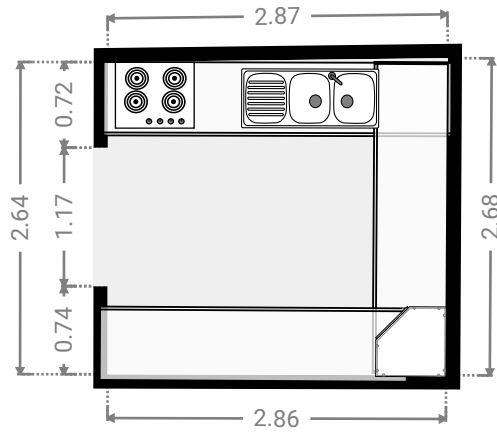
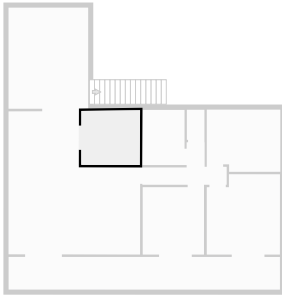

▼ **Other**  
1st Floor

WIDTH: 3.90 m • LENGTH: 4.95 m  
AREA: 19.31 m<sup>2</sup> • PERIMETER: 17.70 m

