

286 Dempsey Street

Created on
2020-08-13

Floors
1

▼ Ground Floor

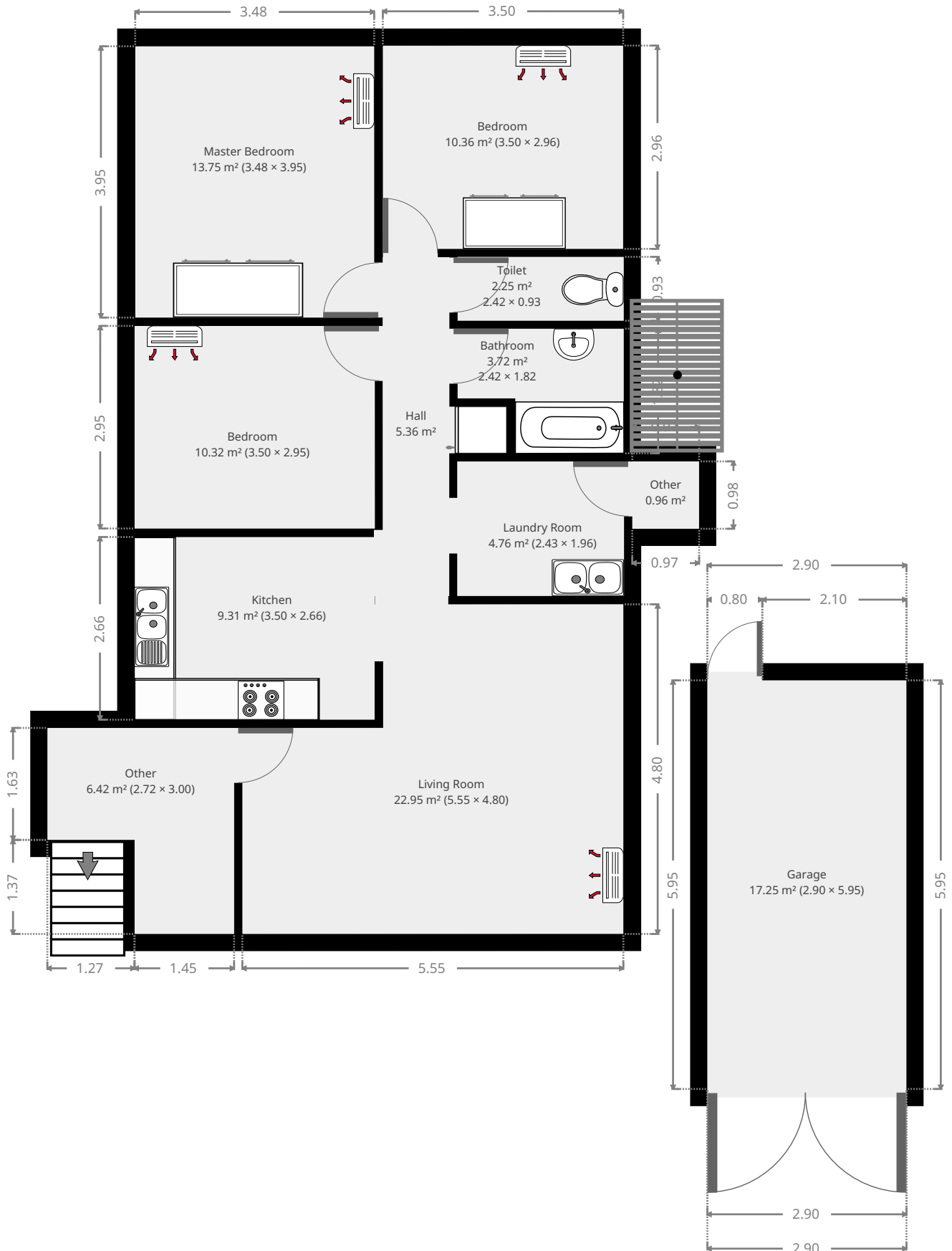

THIS FLOORPLAN IS PROVIDED WITHOUT WARRANTY OF ANY KIND. SENSOPIA DISCLAIMS ANY WARRANTY INCLUDING, WITHOUT LIMITATION, SATISFACTORY QUALITY OR ACCURACY OF DIMENSIONS.

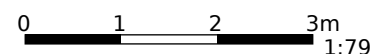

FLOORS: 1

▼ Living Room Ground Floor

WIDTH: 5.55 m • LENGTH: 4.80 m
AREA: 22.95 m² • PERIMETER: 20.70 m

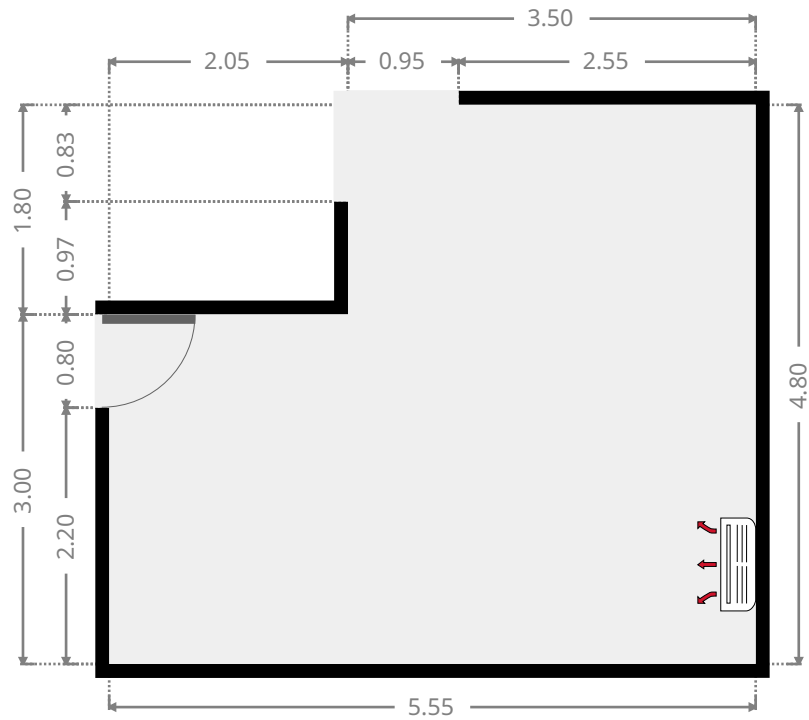
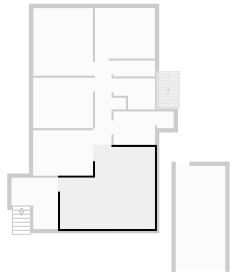

▼ Kitchen Ground Floor

WIDTH: 3.50 m • LENGTH: 2.66 m
AREA: 9.31 m² • PERIMETER: 12.32 m

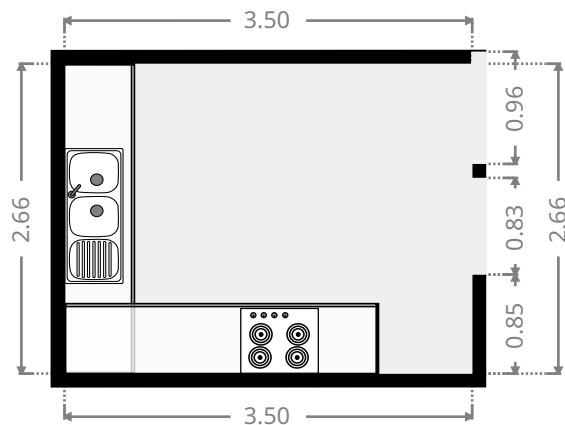
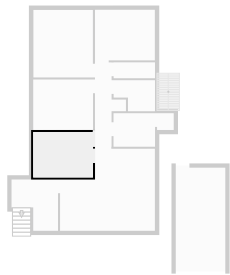

▼ **Hall**
Ground Floor

WIDTH: 1.81 m • **LENGTH:** 4.94 m
AREA: 5.36 m² • **PERIMETER:** 13.50 m

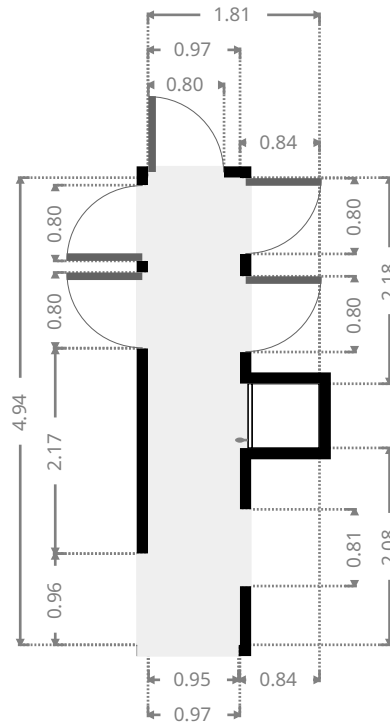
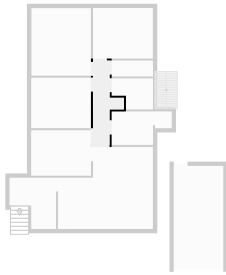

▼ **Laundry Room**
Ground Floor

WIDTH: 2.43 m • **LENGTH:** 1.96 m
AREA: 4.76 m² • **PERIMETER:** 8.78 m

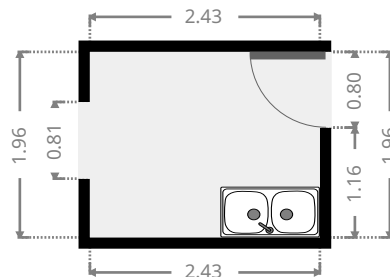

▼ **Bedroom**
Ground Floor

WIDTH: 3.50 m • LENGTH: 2.95 m
AREA: 10.32 m² • PERIMETER: 12.90 m

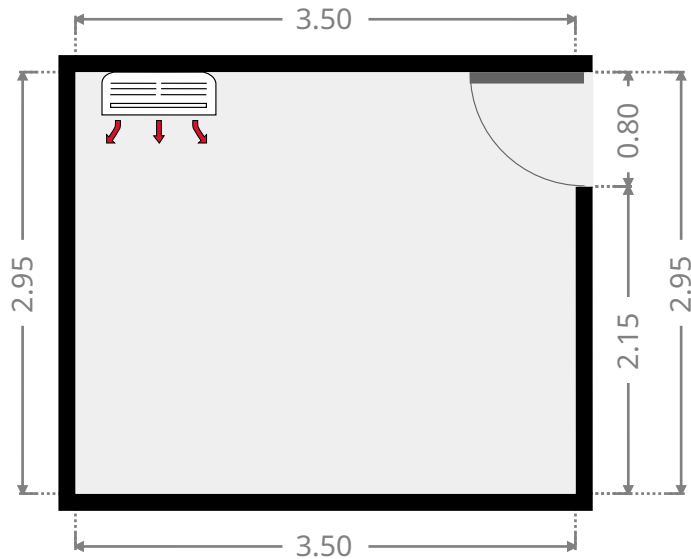
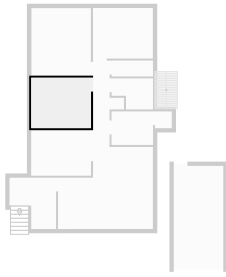

▼ **Master Bedroom**
Ground Floor

WIDTH: 3.48 m • LENGTH: 3.95 m
AREA: 13.75 m² • PERIMETER: 14.86 m

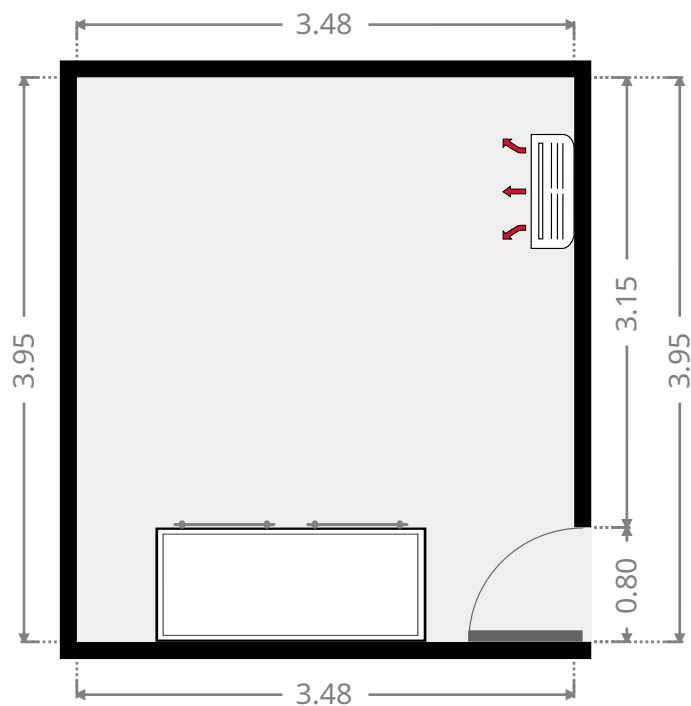
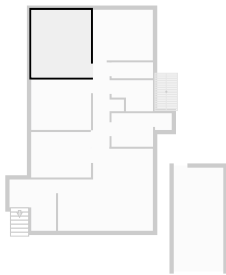

▼ **Bedroom**
Ground Floor

WIDTH: 3.50 m • LENGTH: 2.96 m
AREA: 10.36 m² • PERIMETER: 12.92 m

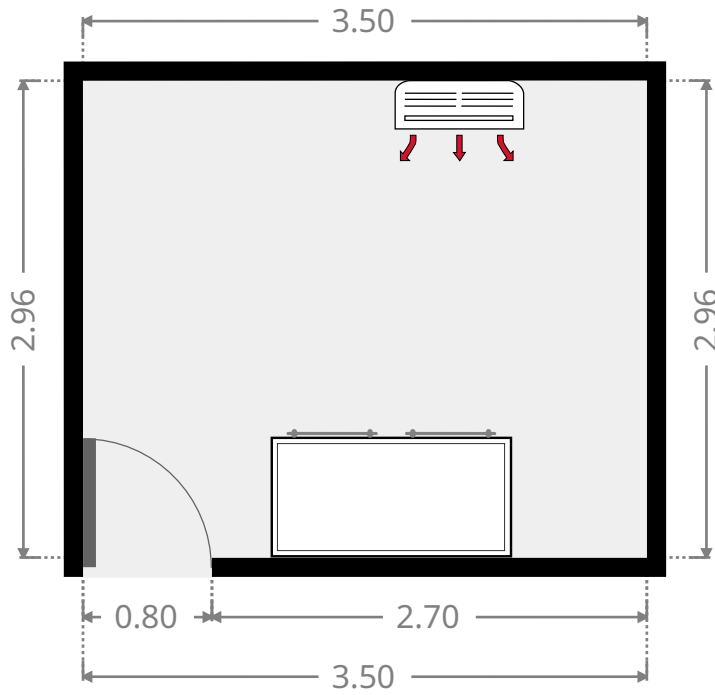
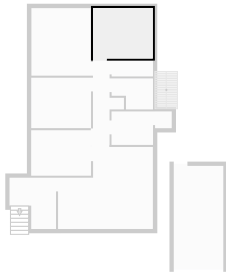

▼ **Toilet**
Ground Floor

WIDTH: 2.42 m • LENGTH: 0.93 m
AREA: 2.25 m² • PERIMETER: 6.70 m

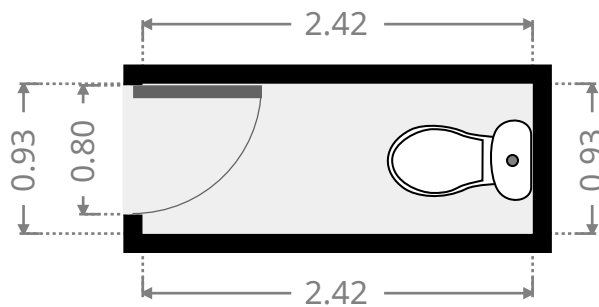
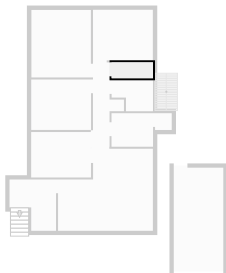

FLOORS: 1

▼ **Bathroom**
Ground Floor

WIDTH: 2.42 m • LENGTH: 1.82 m
AREA: 3.72 m² • PERIMETER: 8.47 m

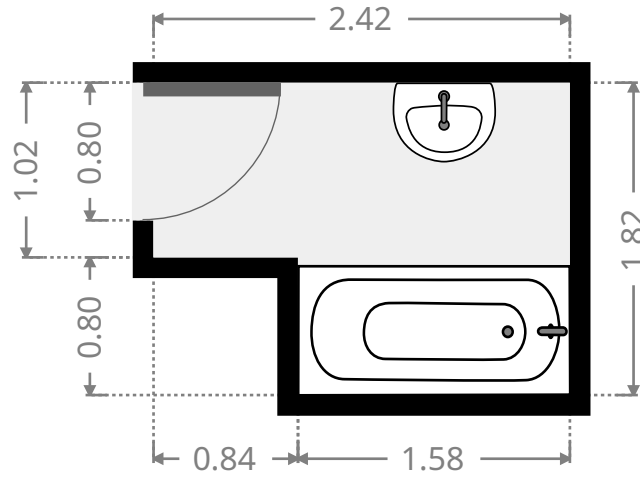
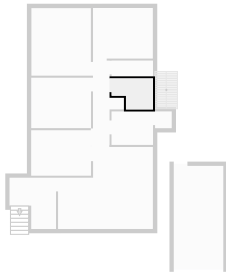

▼ **Other**
Ground Floor

WIDTH: 2.72 m • LENGTH: 3.00 m
AREA: 6.42 m² • PERIMETER: 11.44 m

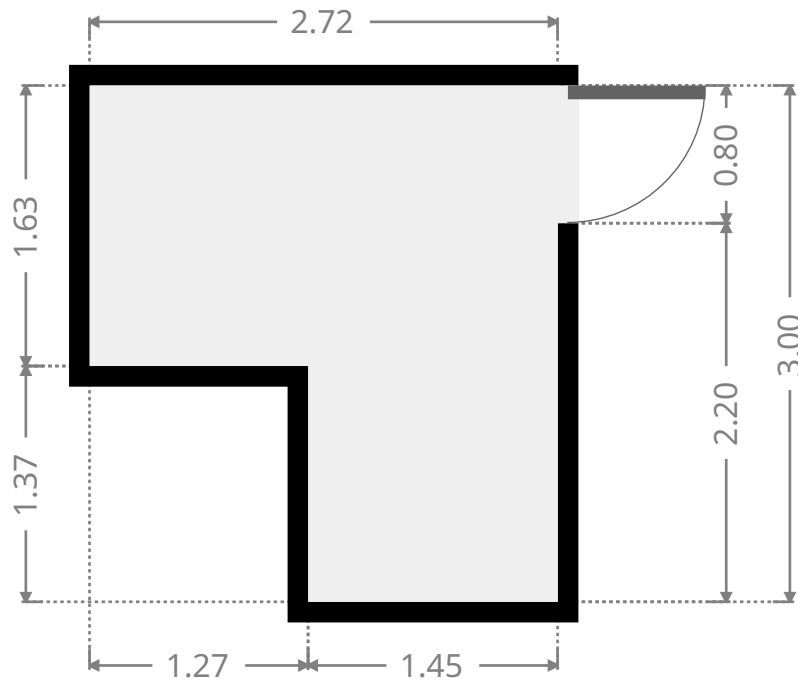
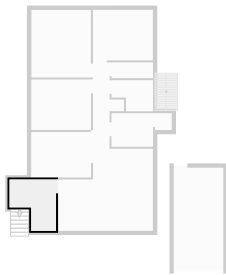

▼ Garage Ground Floor

WIDTH: 2.90 m • LENGTH: 5.95 m
AREA: 17.25 m² • PERIMETER: 17.70 m

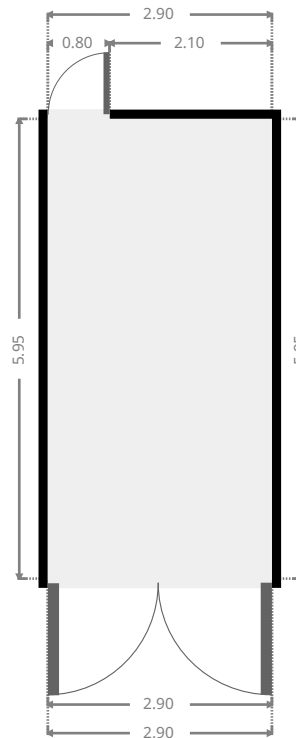
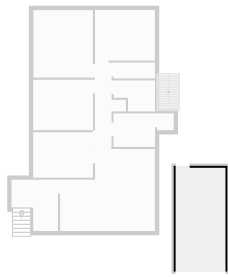

▼ Other Ground Floor

WIDTH: 0.97 m • LENGTH: 0.98 m
AREA: 0.96 m² • PERIMETER: 3.91 m

