

# 284 Richardson Road

## Ground Floor

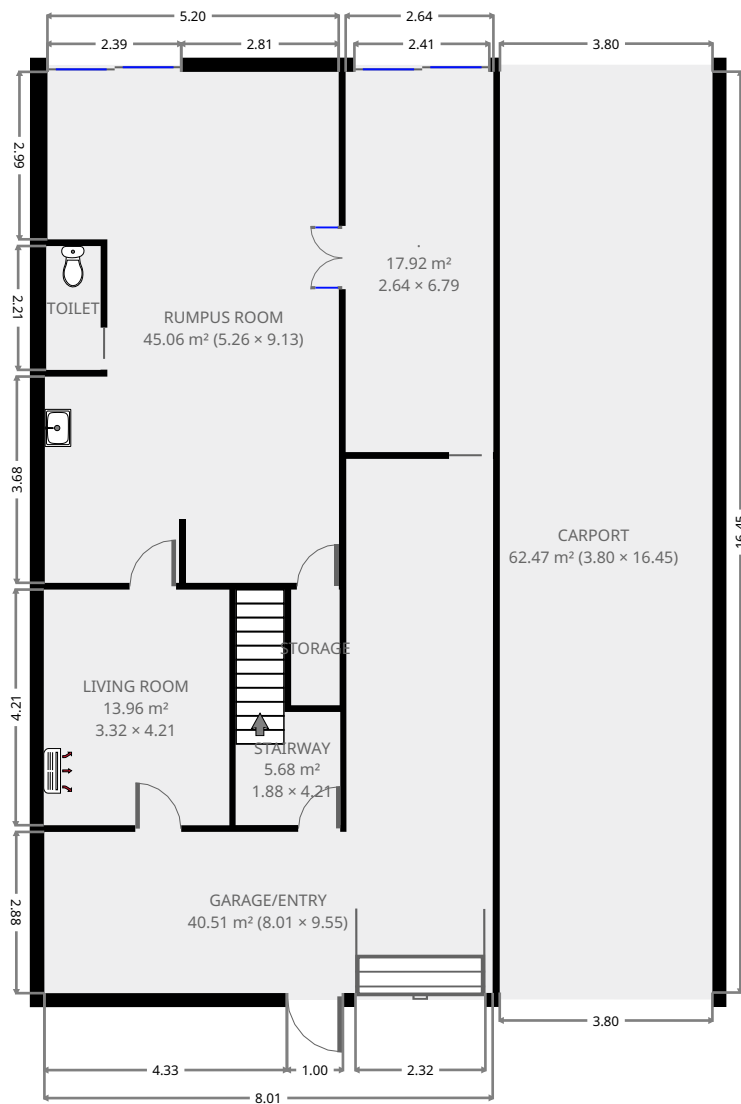

THIS FLOORPLAN IS PROVIDED WITHOUT WARRANTY OF ANY KIND. SENSOPIA DISCLAIMS ANY WARRANTY INCLUDING, WITHOUT LIMITATION, SATISFACTORY QUALITY OR ACCURACY OF DIMENSIONS.

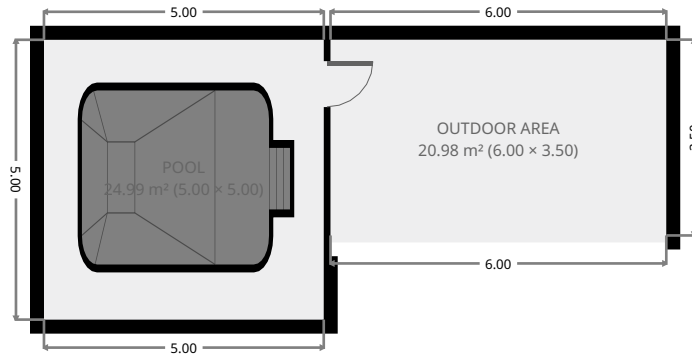

# 284 Richardson Road

## Garage/Entry

Width: 8.01 m  
 Length: 9.55 m  
 Area: 40.51 m<sup>2</sup>  
 Perimeter: 35.11 m

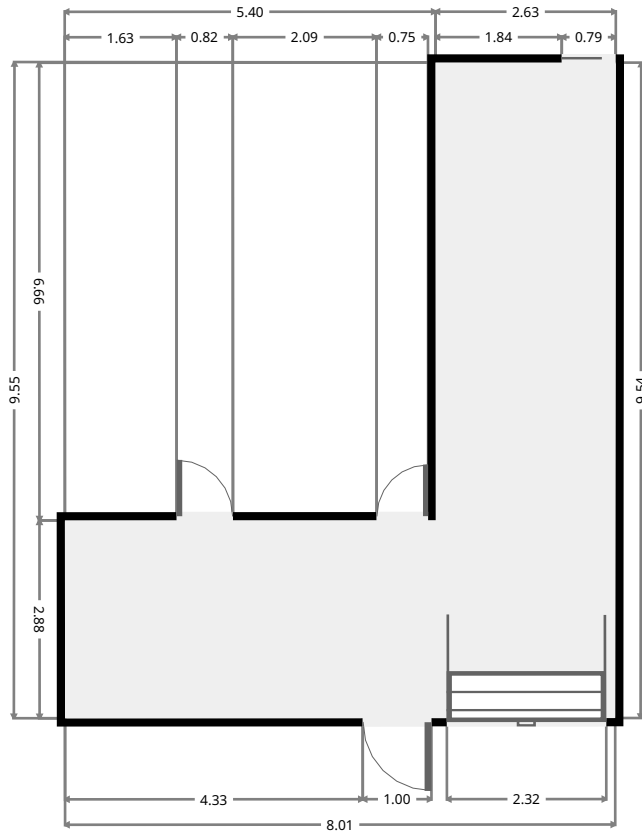
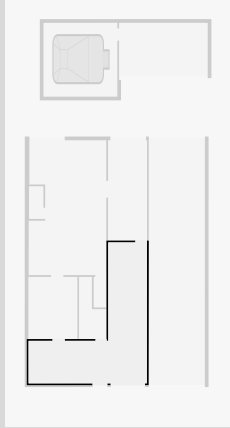

## Living Room

Width: 3.32 m  
 Length: 4.21 m  
 Area: 13.96 m<sup>2</sup>  
 Perimeter: 15.05 m

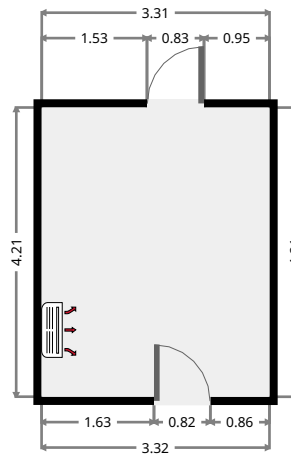
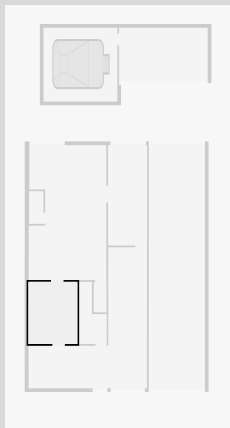

# 284 Richardson Road

## Stairway

Width: 1.88 m  
 Length: 4.21 m  
 Area: 5.68 m<sup>2</sup>  
 Perimeter: 12.15 m

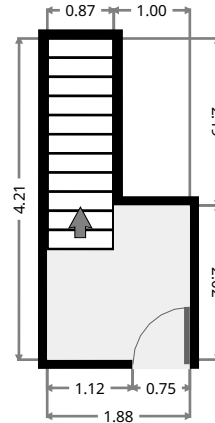
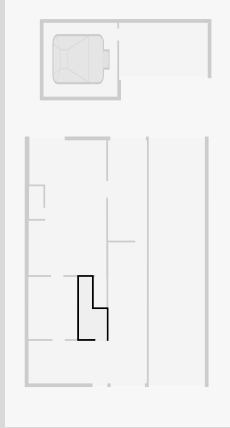

## Rumpus Room

Width: 5.26 m  
 Length: 9.13 m  
 Area: 45.06 m<sup>2</sup>  
 Perimeter: 30.90 m

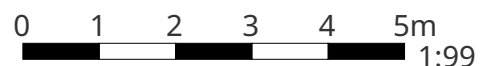
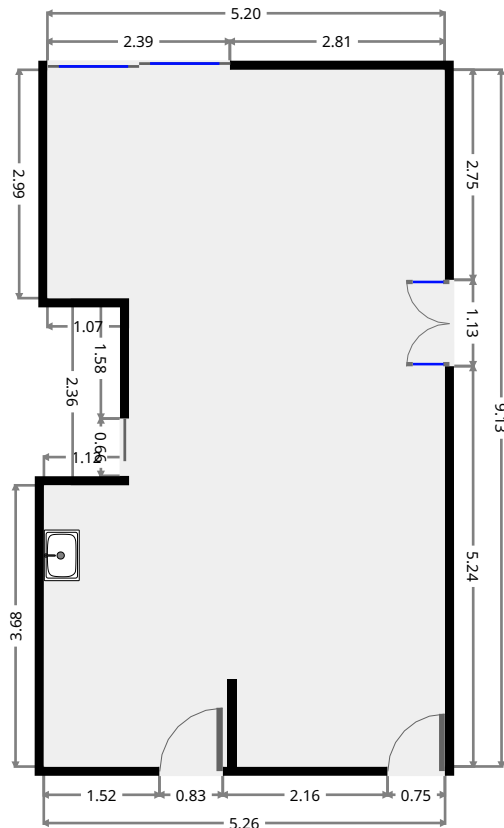
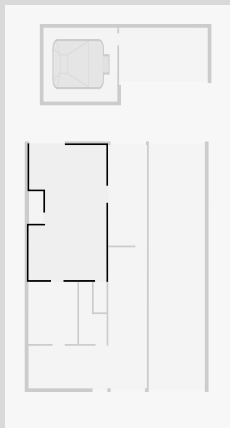

THIS FLOORPLAN IS PROVIDED WITHOUT WARRANTY OF ANY KIND. SENSOPIA DISCLAIMS ANY WARRANTY INCLUDING, WITHOUT LIMITATION, SATISFACTORY QUALITY OR ACCURACY OF DIMENSIONS.

# 284 Richardson Road

## Storage

Width: 1.04 m  
Length: 2.07 m  
Area: 1.79 m<sup>2</sup>  
Perimeter: 5.86 m

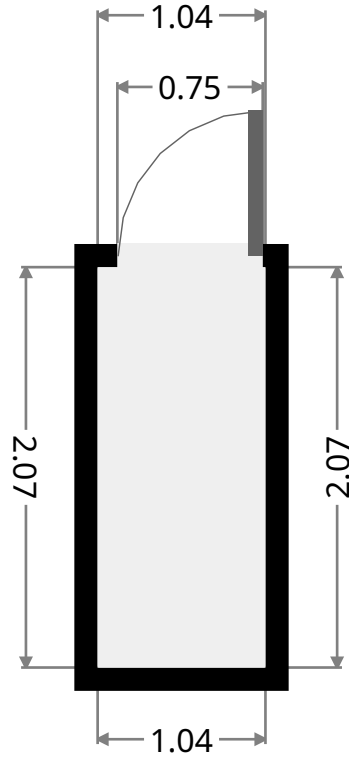
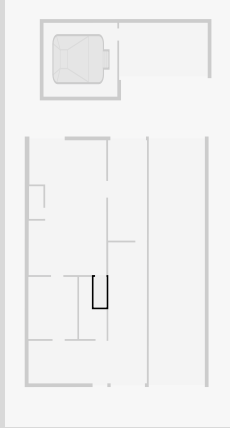

## Toilet

Width: 0.97 m  
Length: 2.21 m  
Area: 2.15 m<sup>2</sup>  
Perimeter: 6.37 m

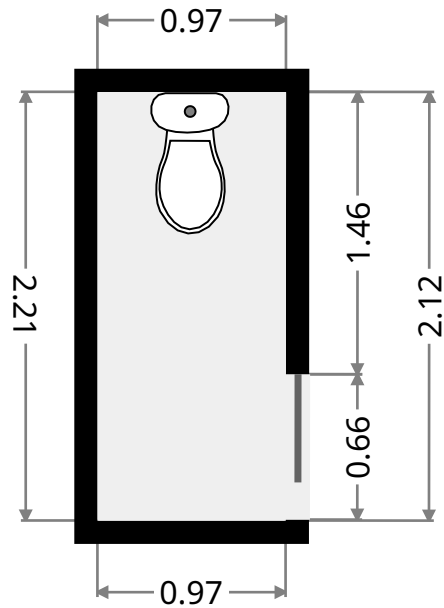
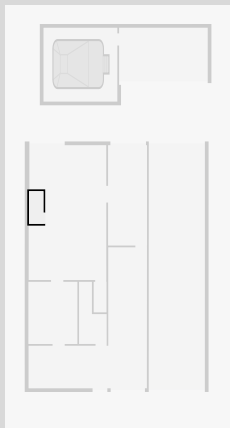

# 284 Richardson Road

•  
Width: 2.64 m  
Length: 6.79 m  
Area: 17.92 m<sup>2</sup>  
Perimeter: 18.86 m

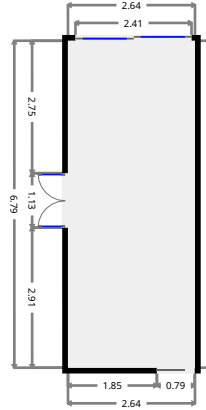
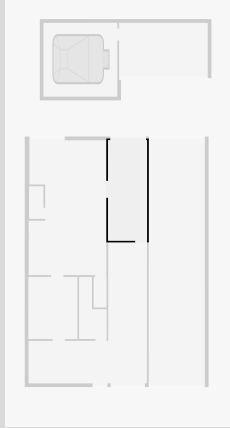

## Carport

Width: 3.80 m  
Length: 16.45 m  
Area: 62.47 m<sup>2</sup>  
Perimeter: 40.49 m

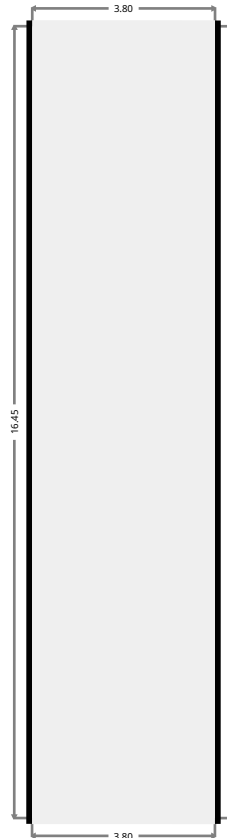
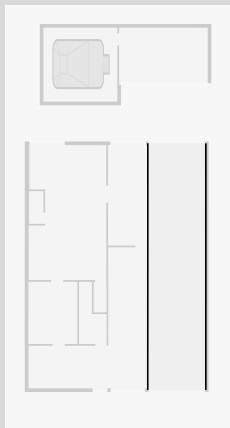

# 284 Richardson Road

## Outdoor Area

Width: 3.50 m  
Length: 6.00 m  
Area: 20.98 m<sup>2</sup>  
Perimeter: 18.99 m

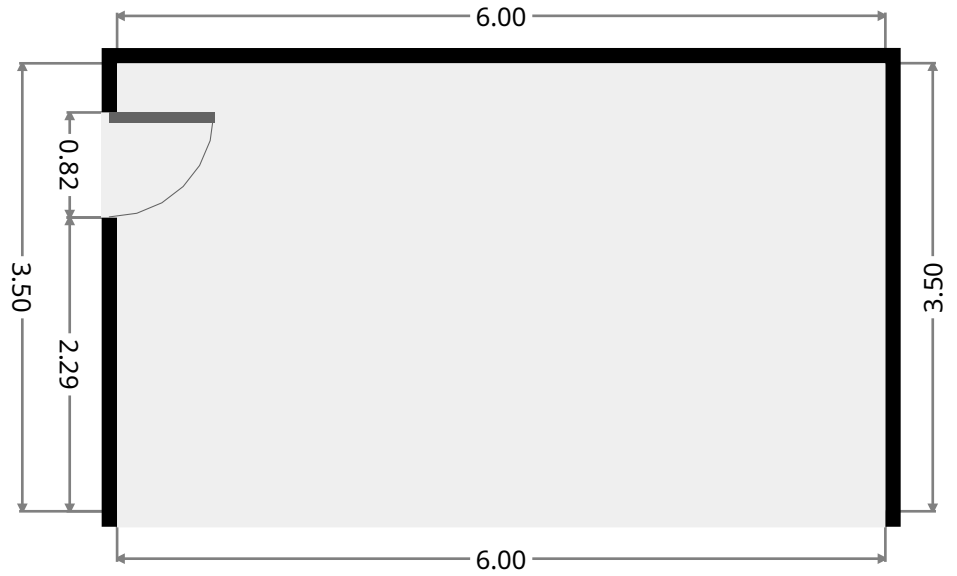
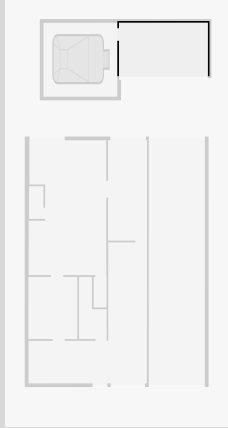

## Pool

Width: 5.00 m  
Length: 5.00 m  
Area: 24.99 m<sup>2</sup>  
Perimeter: 19.99 m

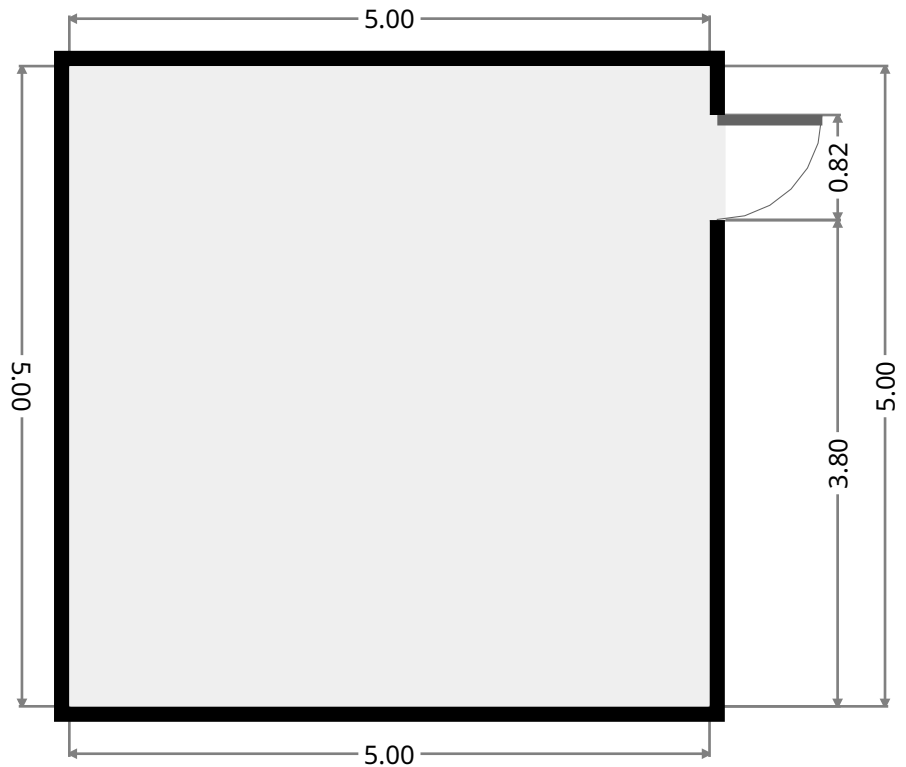
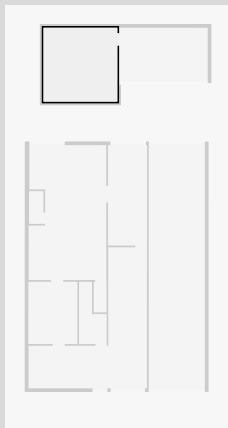

# 284 Richardson Road

## 1st Floor

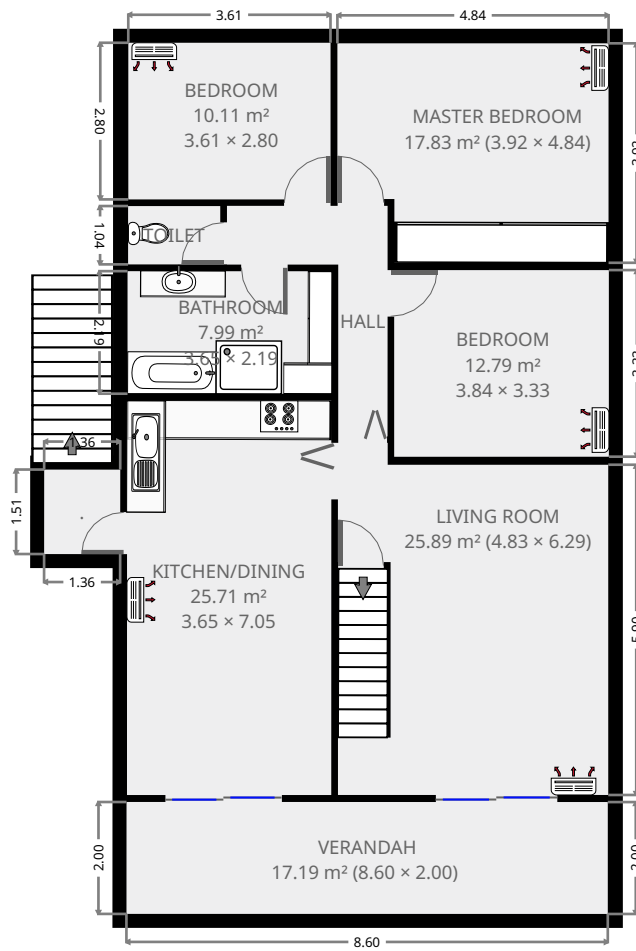

THIS FLOORPLAN IS PROVIDED WITHOUT WARRANTY OF ANY KIND. SENSOPIA DISCLAIMS ANY WARRANTY INCLUDING, WITHOUT LIMITATION, SATISFACTORY QUALITY OR ACCURACY OF DIMENSIONS.



# 284 Richardson Road

## Living Room

Width: 4.83 m  
 Length: 6.29 m  
 Area: 25.89 m<sup>2</sup>  
 Perimeter: 24.12 m

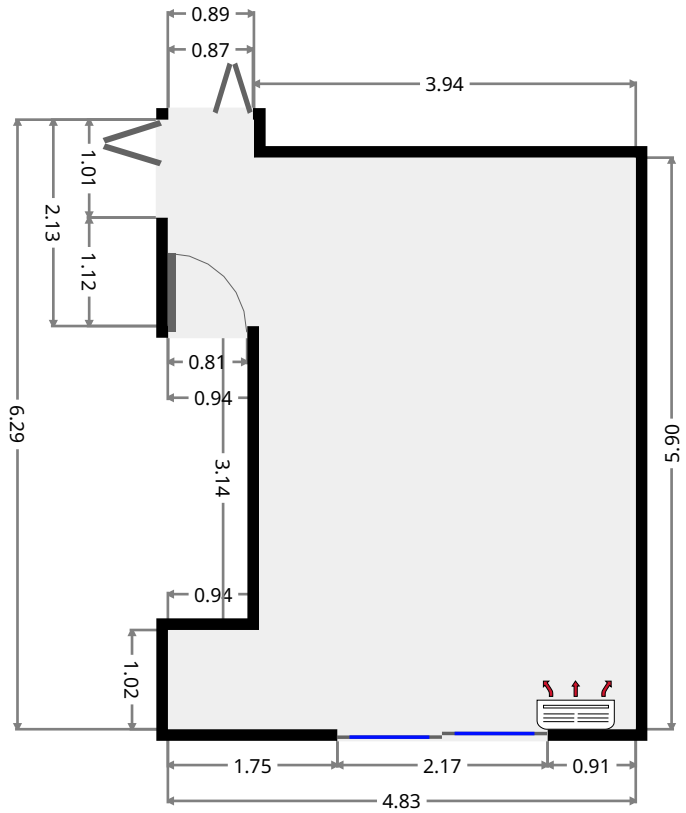
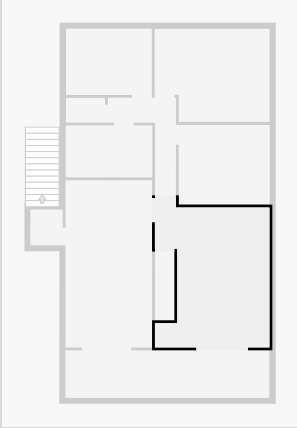

## Stairway

Width: 0.82 m  
 Length: 2.90 m  
 Area: 2.37 m<sup>2</sup>  
 Perimeter: 7.43 m

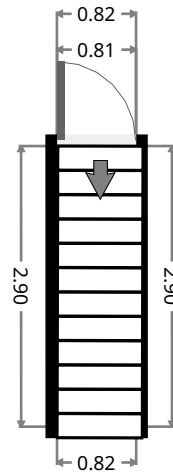
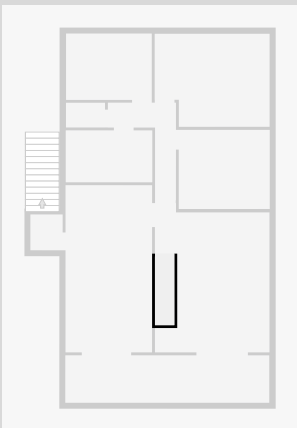



# 284 Richardson Road

## Kitchen/Dining

Width: 3.65 m  
 Length: 7.05 m  
 Area: 25.71 m<sup>2</sup>  
 Perimeter: 21.39 m

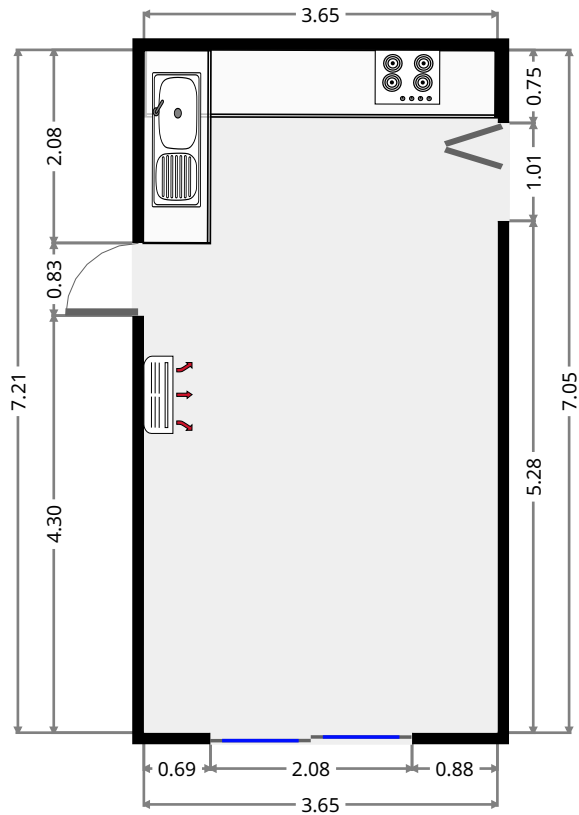
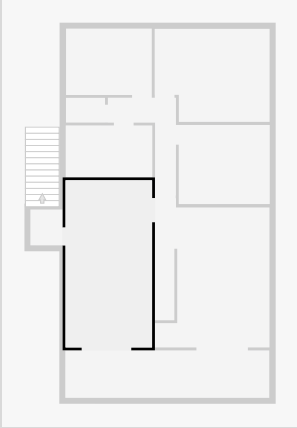

## Hall

Width: 2.87 m  
 Length: 4.12 m  
 Area: 5.71 m<sup>2</sup>  
 Perimeter: 13.97 m

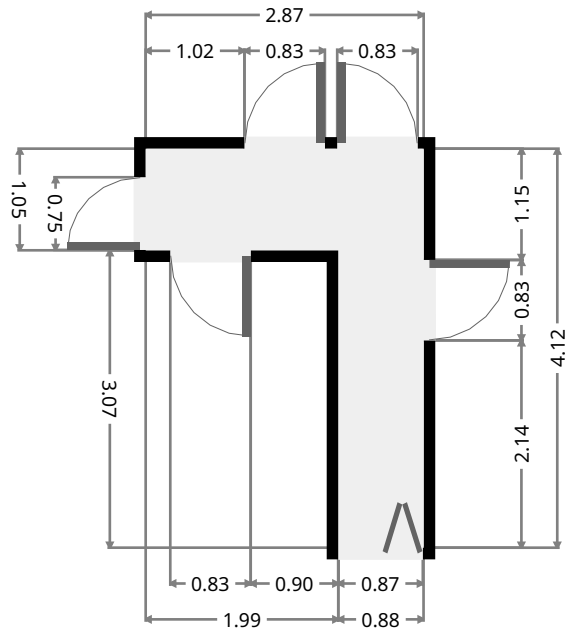
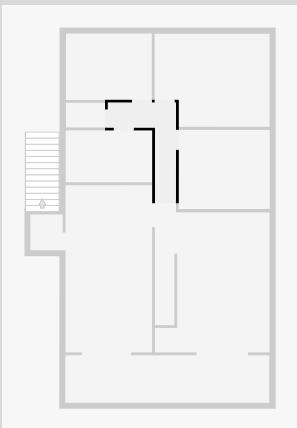

THIS FLOORPLAN IS PROVIDED WITHOUT WARRANTY OF ANY KIND. SENSOPIA DISCLAIMS ANY WARRANTY INCLUDING, WITHOUT LIMITATION, SATISFACTORY QUALITY OR ACCURACY OF DIMENSIONS.



# 284 Richardson Road

## Bedroom

Width: 3.33 m  
 Length: 3.84 m  
 Area: 12.79 m<sup>2</sup>  
 Perimeter: 14.34 m

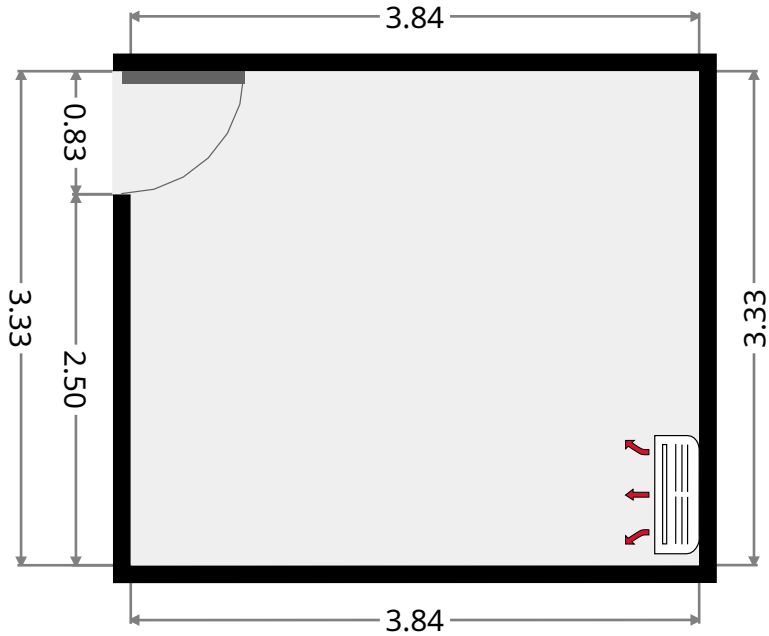
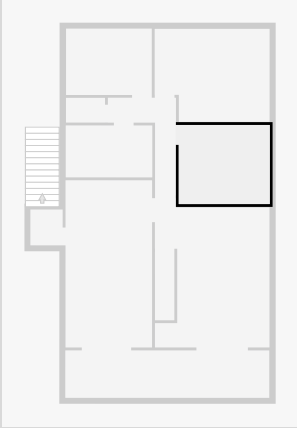

## Master Bedroom

Width: 3.92 m  
 Length: 4.84 m  
 Area: 17.83 m<sup>2</sup>  
 Perimeter: 17.53 m

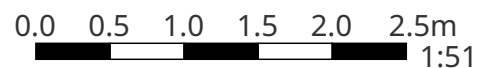
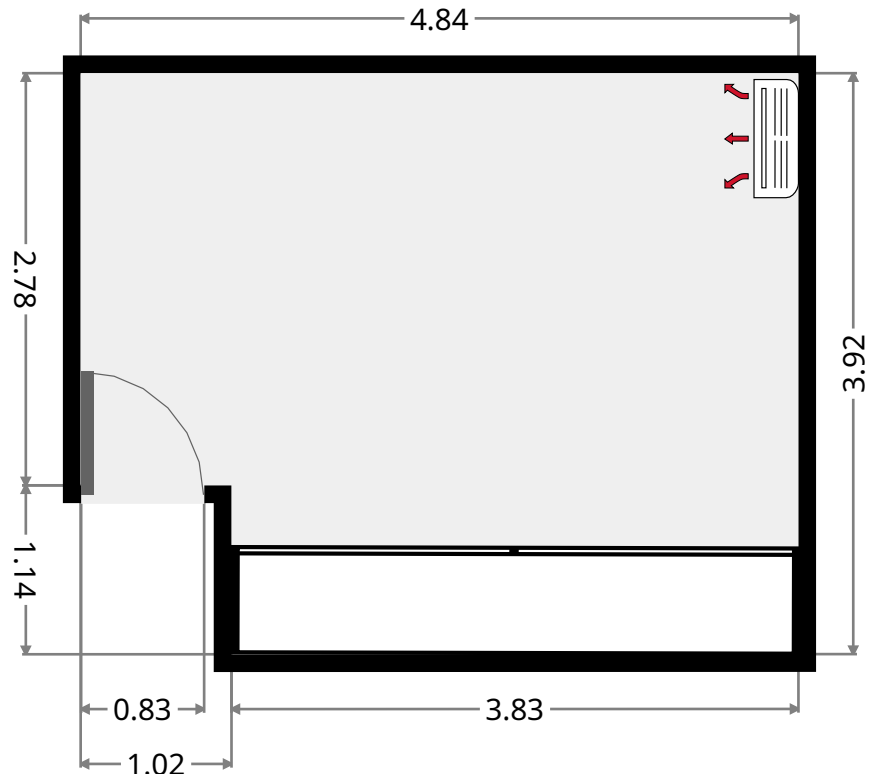
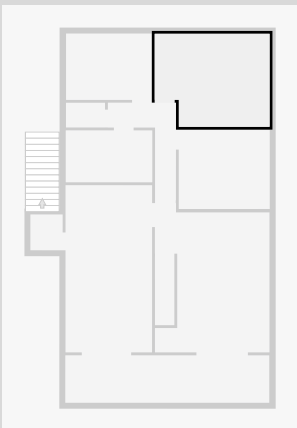

# 284 Richardson Road

## Bedroom

Width: 2.80 m  
Length: 3.61 m  
Area: 10.11 m<sup>2</sup>  
Perimeter: 12.82 m

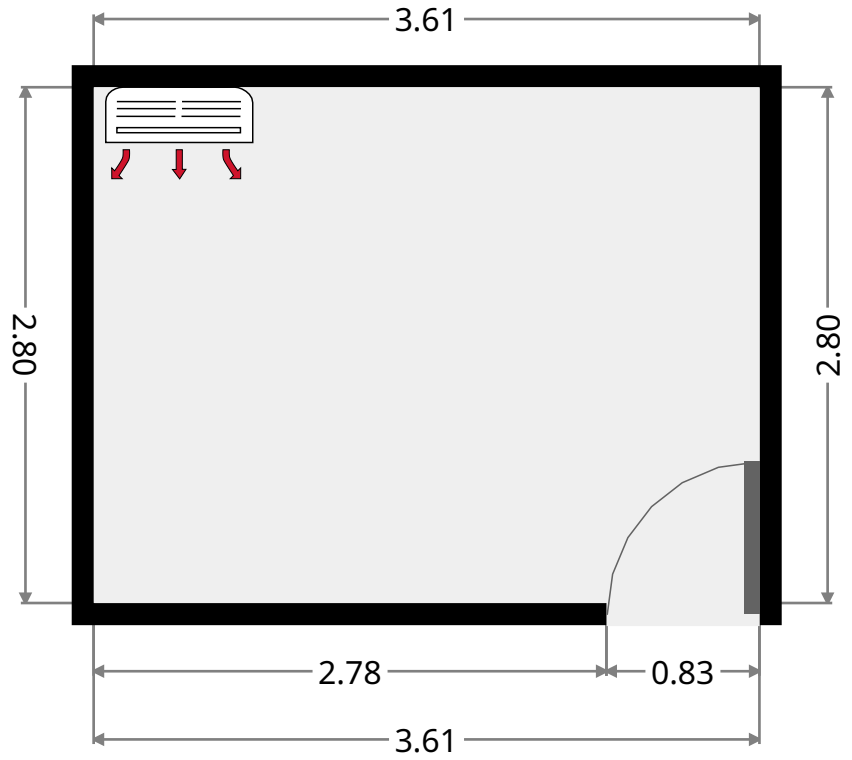
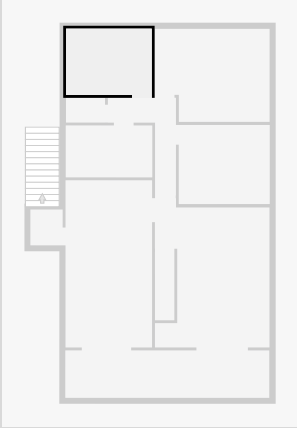

## Bathroom

Width: 2.19 m  
Length: 3.65 m  
Area: 7.99 m<sup>2</sup>  
Perimeter: 11.67 m

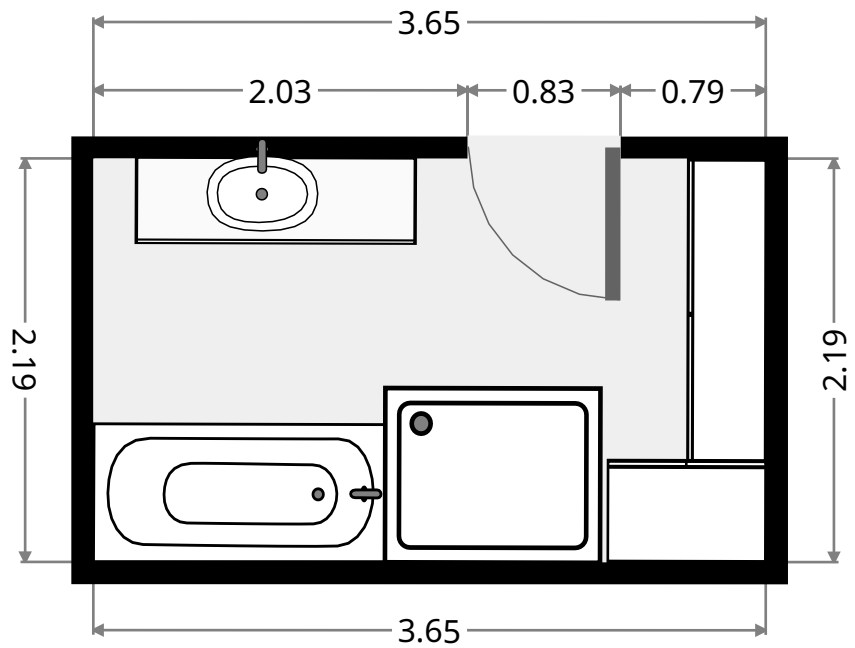
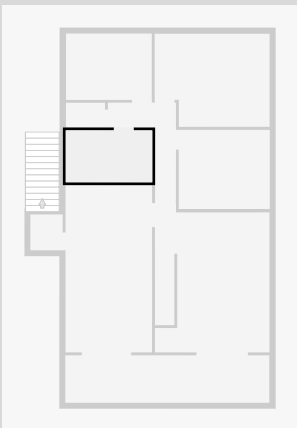

# 284 Richardson Road

## Toilet

Width: 1.04 m  
Length: 1.65 m  
Area: 1.72 m<sup>2</sup>  
Perimeter: 5.38 m

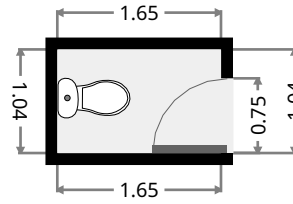
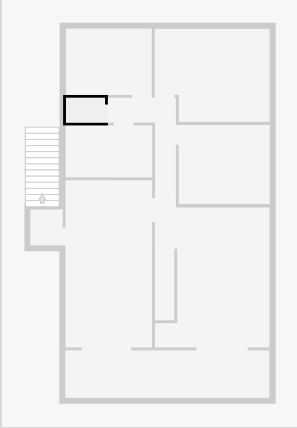

## Verandah

Width: 2.00 m  
Length: 8.60 m  
Area: 17.19 m<sup>2</sup>  
Perimeter: 21.20 m

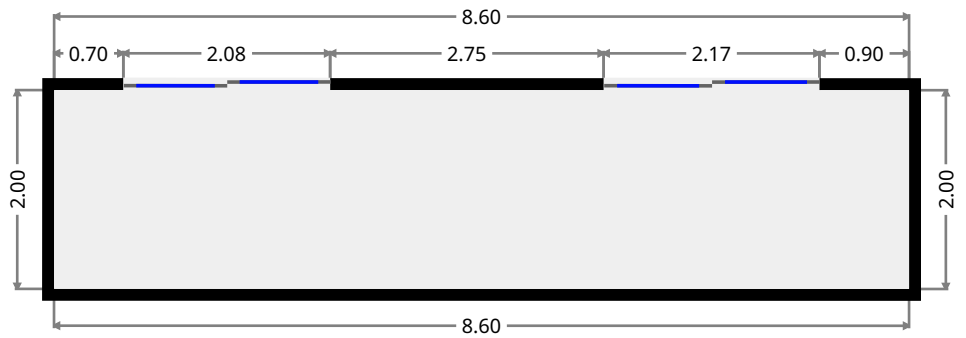
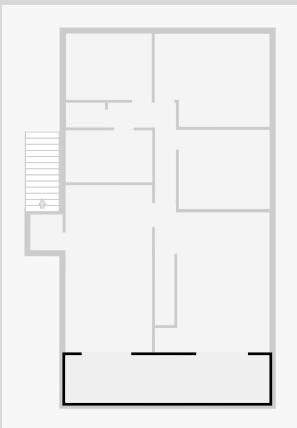

# 284 Richardson Road

•  
Width: 1.36 m  
Length: 1.50 m  
Area: 2.05 m<sup>2</sup>  
Perimeter: 5.74 m

