

28 Rundle Street

Ground Floor

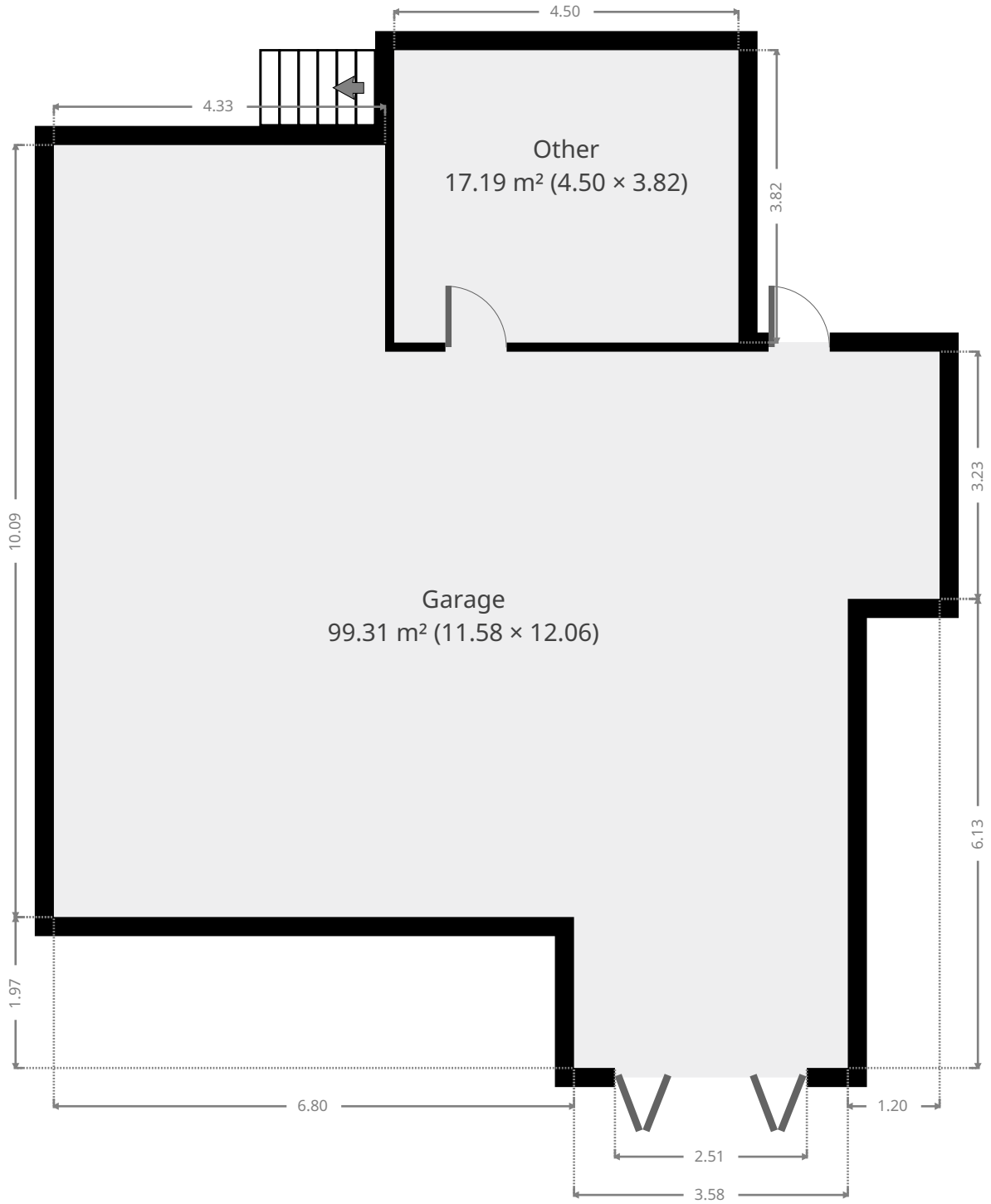

THIS FLOORPLAN IS PROVIDED WITHOUT WARRANTY OF ANY KIND. SENSOPIA DISCLAIMS ANY WARRANTY INCLUDING, WITHOUT LIMITATION, SATISFACTORY QUALITY OR ACCURACY OF DIMENSIONS.



28 Rundle Street

Garage

Width: 11.58 m
Length: 12.06 m
Area: 99.31 m²
Perimeter: 47.28 m

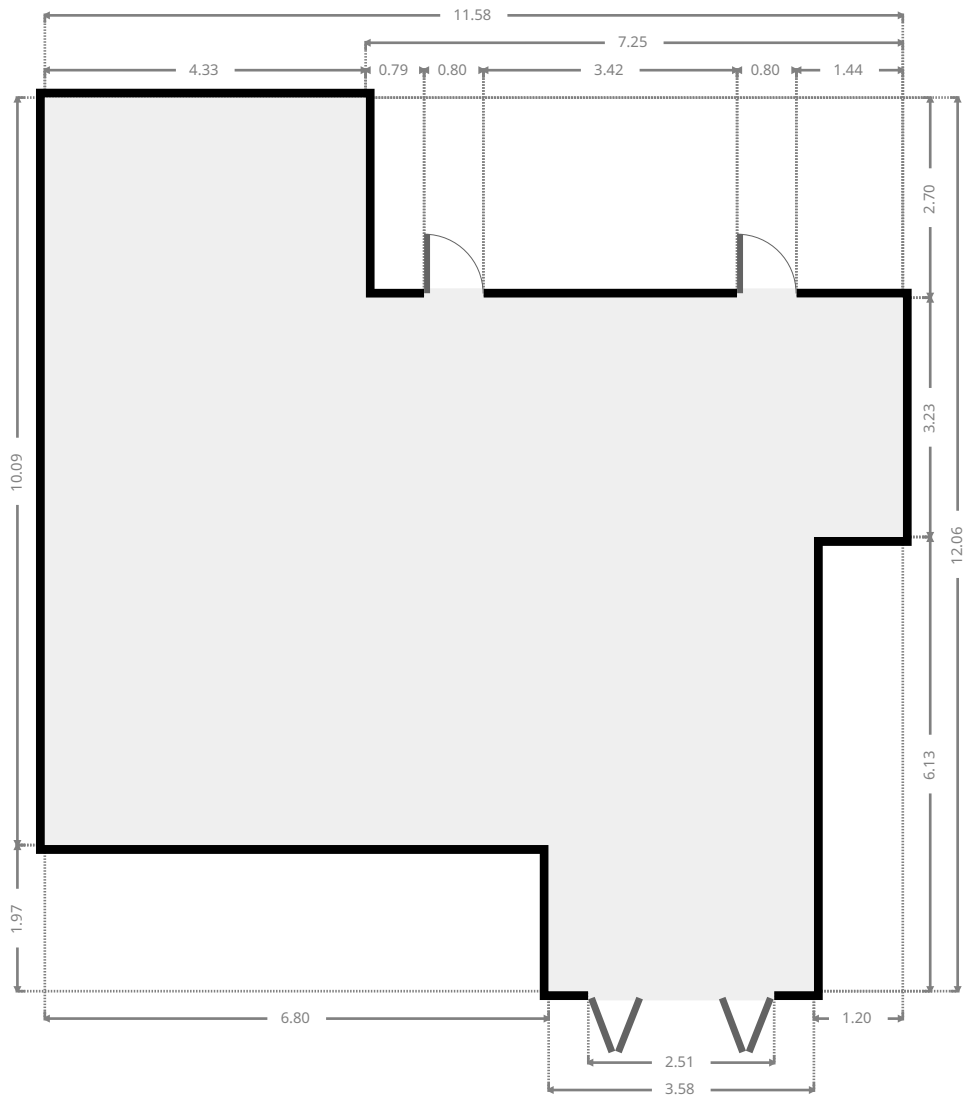
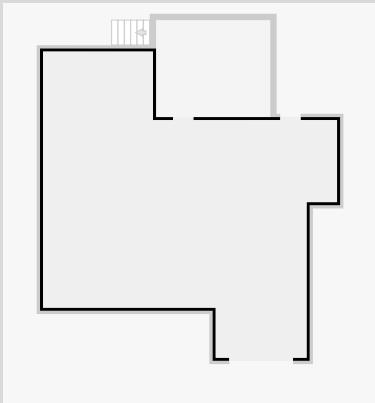

THIS FLOORPLAN IS PROVIDED WITHOUT WARRANTY OF ANY KIND. SENSOPIA DISCLAIMS ANY WARRANTY INCLUDING, WITHOUT LIMITATION, SATISFACTORY QUALITY OR ACCURACY OF DIMENSIONS.

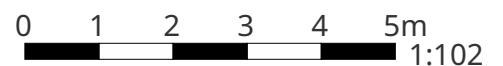

28 Rundle Street

Other

Width:	3.82 m
Length:	4.50 m
Area	17.19 m ²
Perimeter	16.64 m

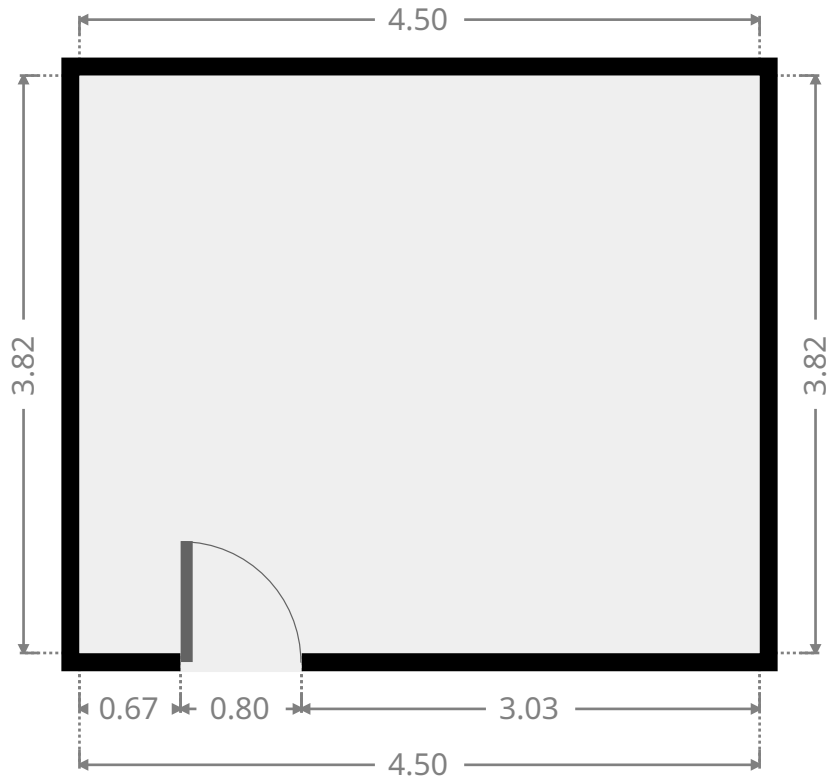
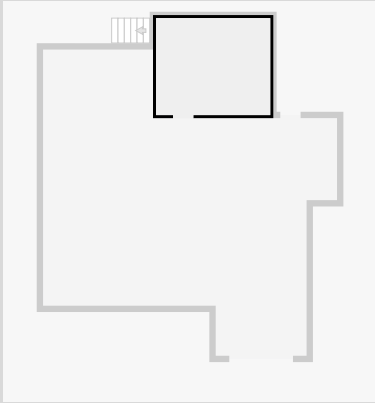

28 Rundle Street

1st Floor

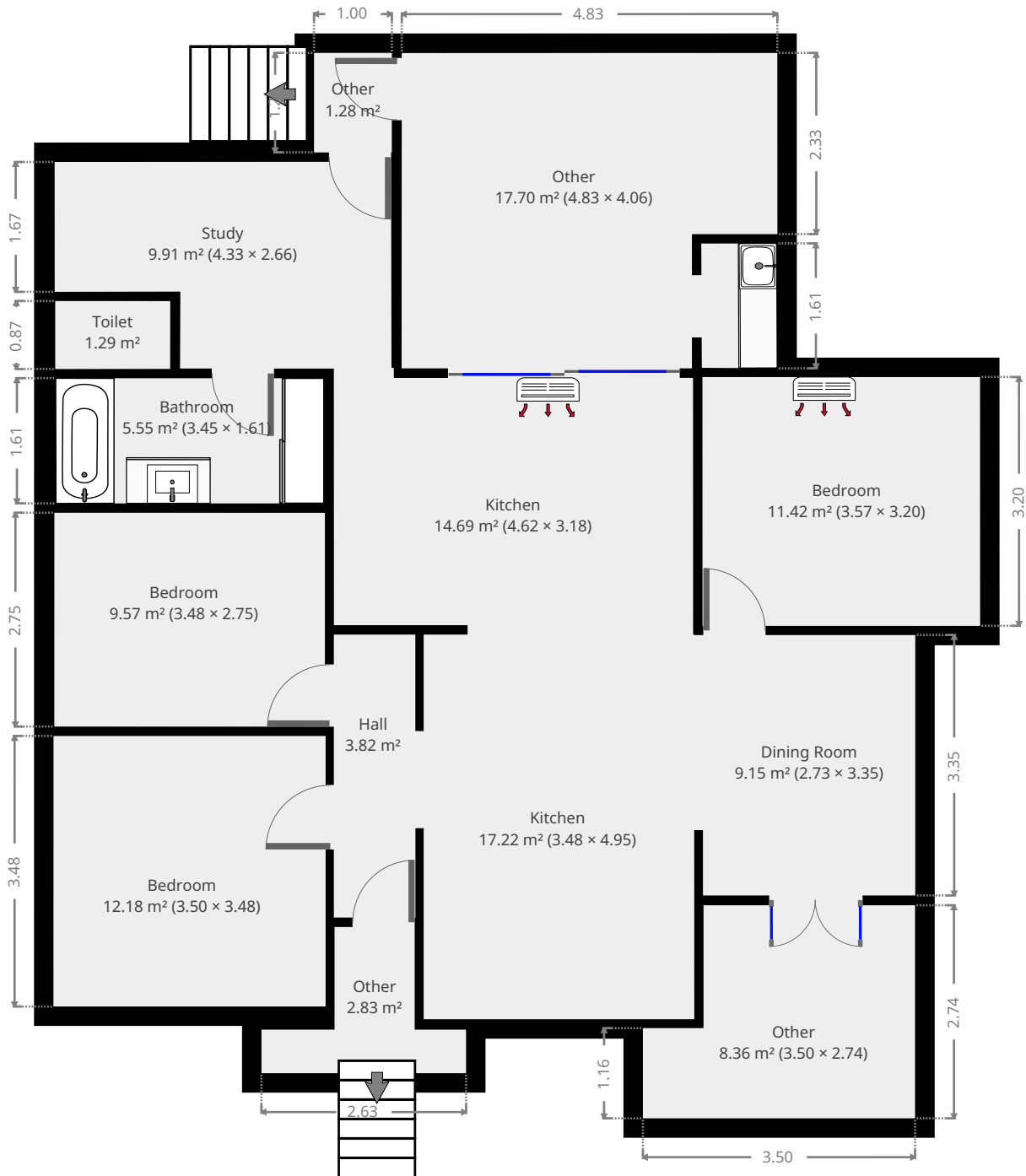

THIS FLOORPLAN IS PROVIDED WITHOUT WARRANTY OF ANY KIND. SENSOPIA DISCLAIMS ANY WARRANTY INCLUDING, WITHOUT LIMITATION, SATISFACTORY QUALITY OR ACCURACY OF DIMENSIONS.



28 Rundle Street

Hall

Width: 1.05 m
 Length: 3.64 m
 Area: 3.82 m²
 Perimeter: 9.38 m

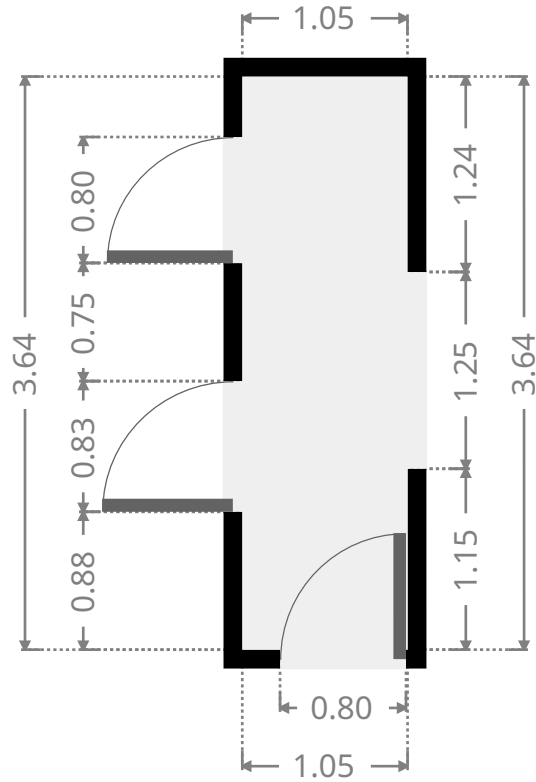
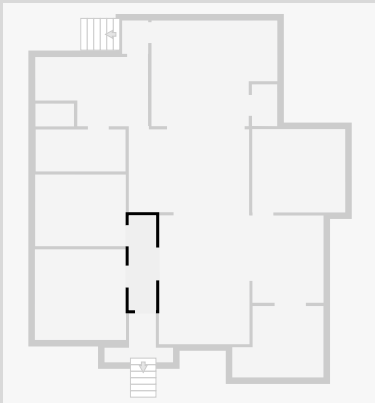

Bedroom

Width: 3.48 m
 Length: 3.50 m
 Area: 12.18 m²
 Perimeter: 13.96 m

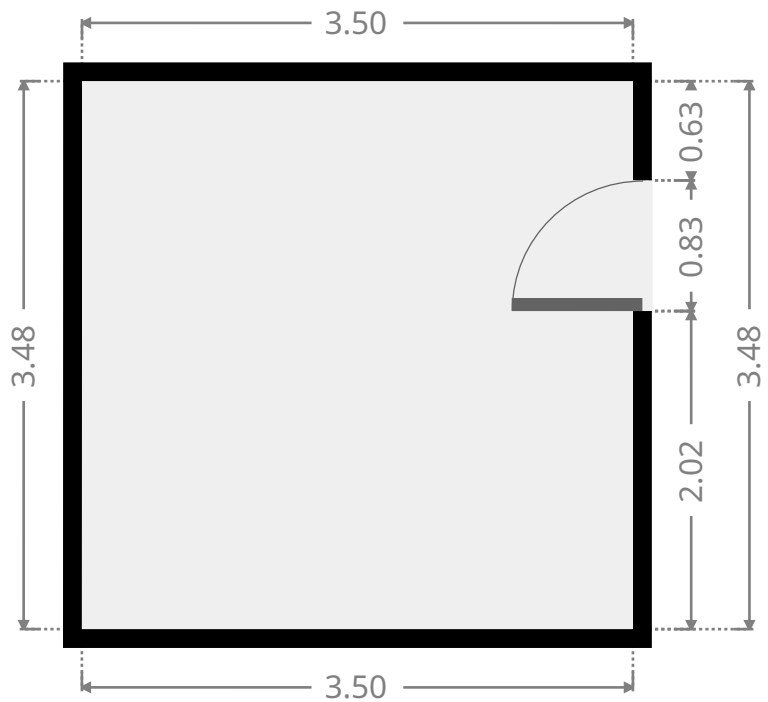
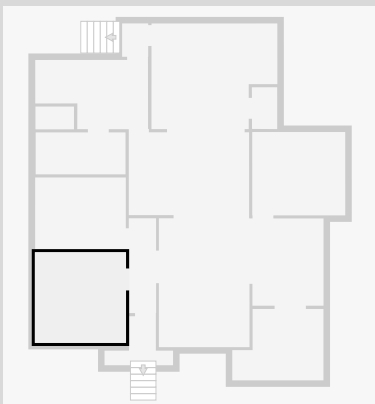

THIS FLOORPLAN IS PROVIDED WITHOUT WARRANTY OF ANY KIND. SENSOPIA DISCLAIMS ANY WARRANTY INCLUDING, WITHOUT LIMITATION, SATISFACTORY QUALITY OR ACCURACY OF DIMENSIONS.

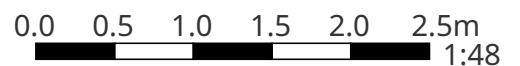

28 Rundle Street

Bedroom

Width: 2.75 m
Length: 3.48 m
Area: 9.57 m²
Perimeter: 12.46 m

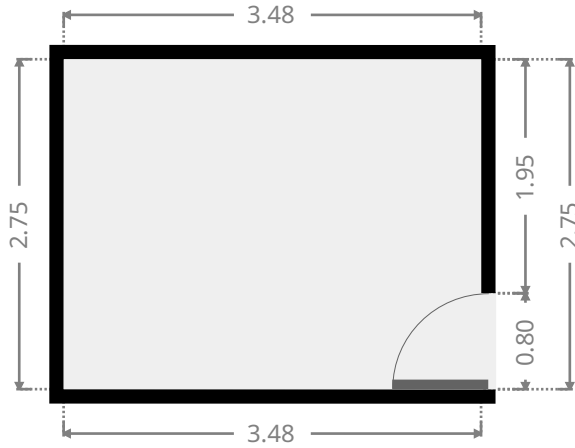
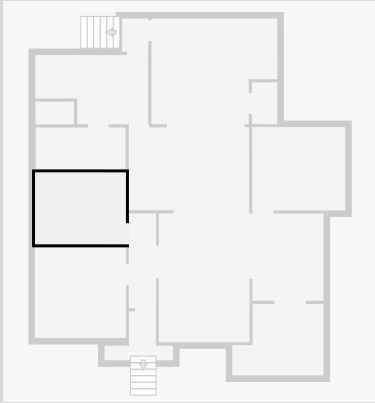

Kitchen

Width: 3.48 m
Length: 4.95 m
Area: 17.22 m²
Perimeter: 16.86 m

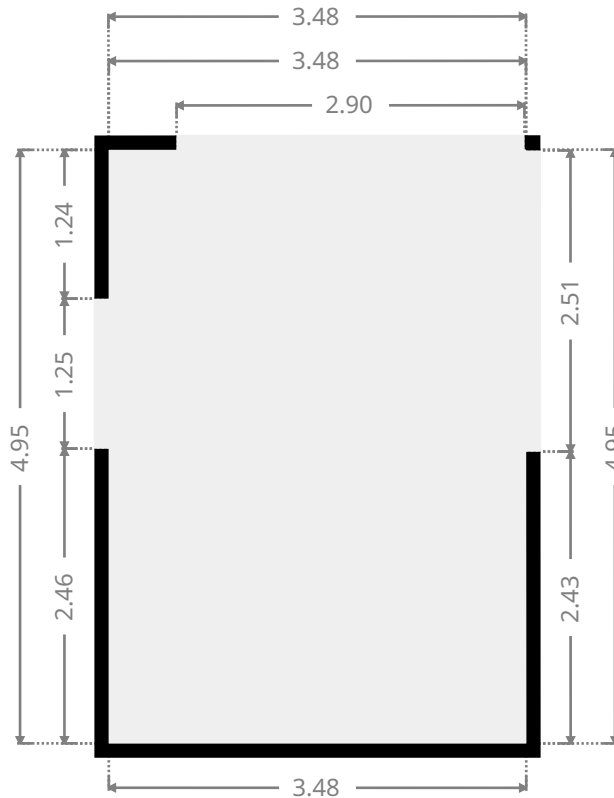

THIS FLOORPLAN IS PROVIDED WITHOUT WARRANTY OF ANY KIND. SENSOPIA DISCLAIMS ANY WARRANTY INCLUDING, WITHOUT LIMITATION, SATISFACTORY QUALITY OR ACCURACY OF DIMENSIONS.

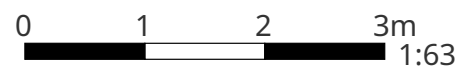

28 Rundle Street

Dining Room

Width: 2.73 m
 Length: 3.35 m
 Area: 9.15 m²
 Perimeter: 12.16 m

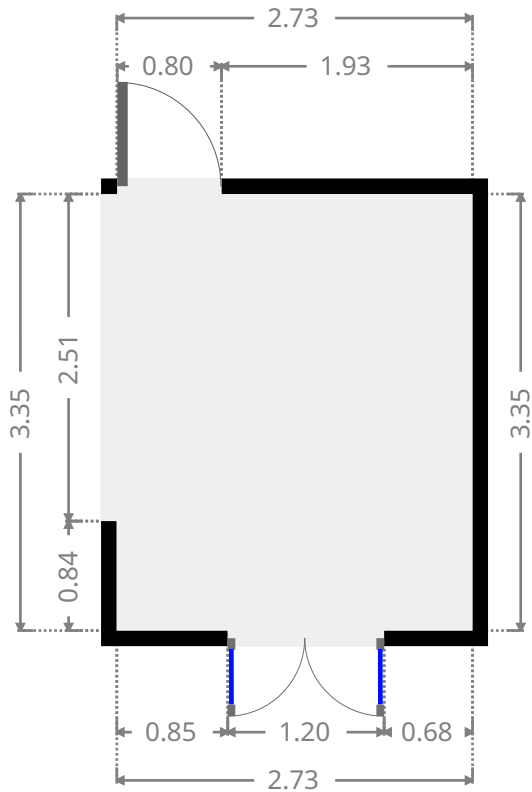
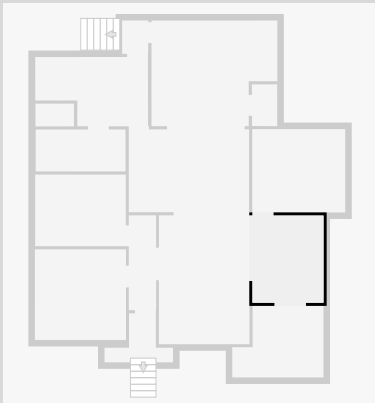

Bedroom

Width: 3.20 m
 Length: 3.57 m
 Area: 11.42 m²
 Perimeter: 13.54 m

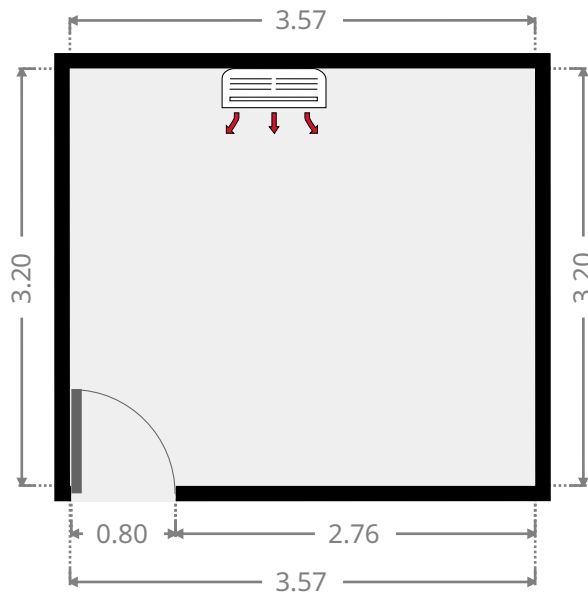
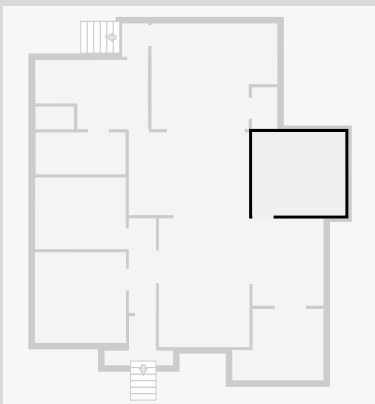

THIS FLOORPLAN IS PROVIDED WITHOUT WARRANTY OF ANY KIND. SENSOPIA DISCLAIMS ANY WARRANTY INCLUDING, WITHOUT LIMITATION, SATISFACTORY QUALITY OR ACCURACY OF DIMENSIONS.

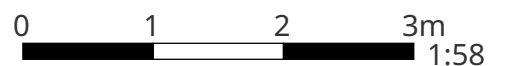

28 Rundle Street

Kitchen

Width: 3.18 m
 Length: 4.62 m
 Area: 14.69 m²
 Perimeter: 15.60 m

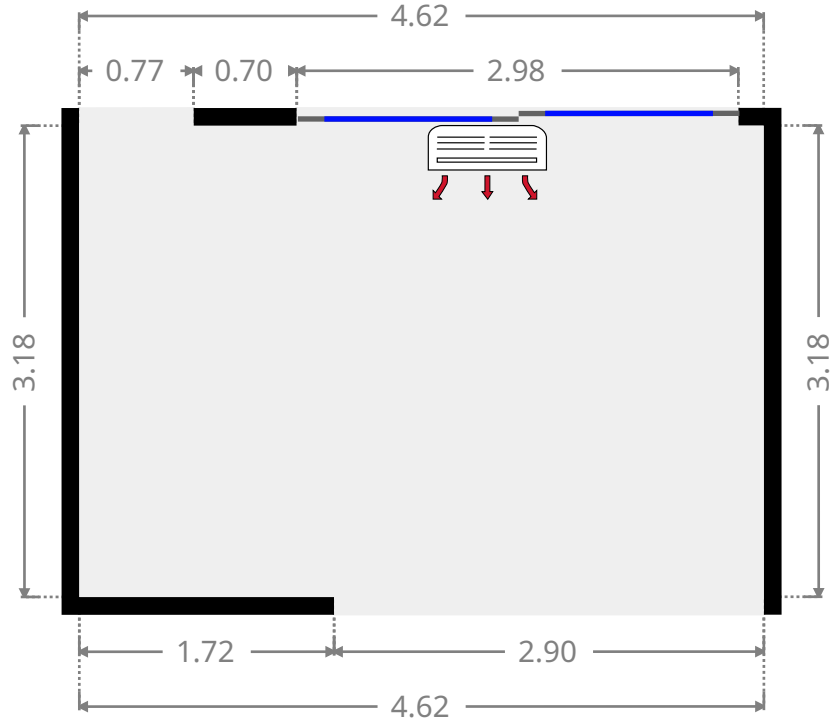
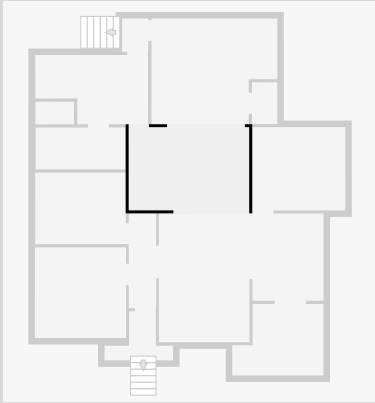

Study

Width: 2.66 m
 Length: 4.33 m
 Area: 9.91 m²
 Perimeter: 13.98 m

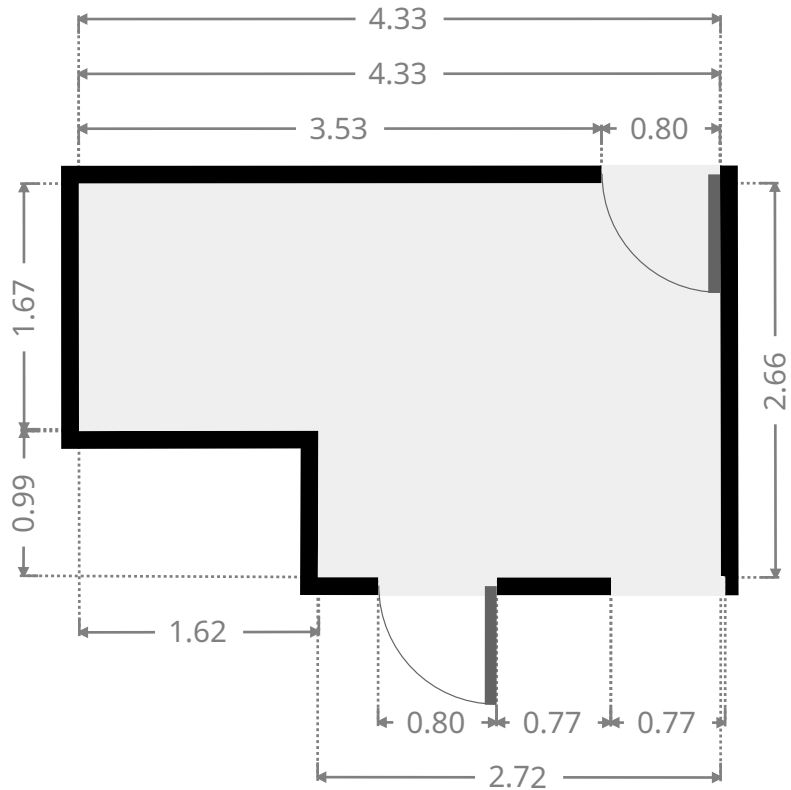
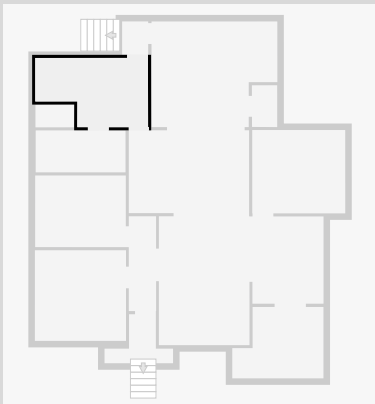

THIS FLOORPLAN IS PROVIDED WITHOUT WARRANTY OF ANY KIND. SENSOPIA DISCLAIMS ANY WARRANTY INCLUDING, WITHOUT LIMITATION, SATISFACTORY QUALITY OR ACCURACY OF DIMENSIONS.

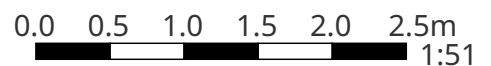

28 Rundle Street

Bathroom

Width: 1.61 m
Length: 3.45 m
Area: 5.55 m²
Perimeter: 10.12 m

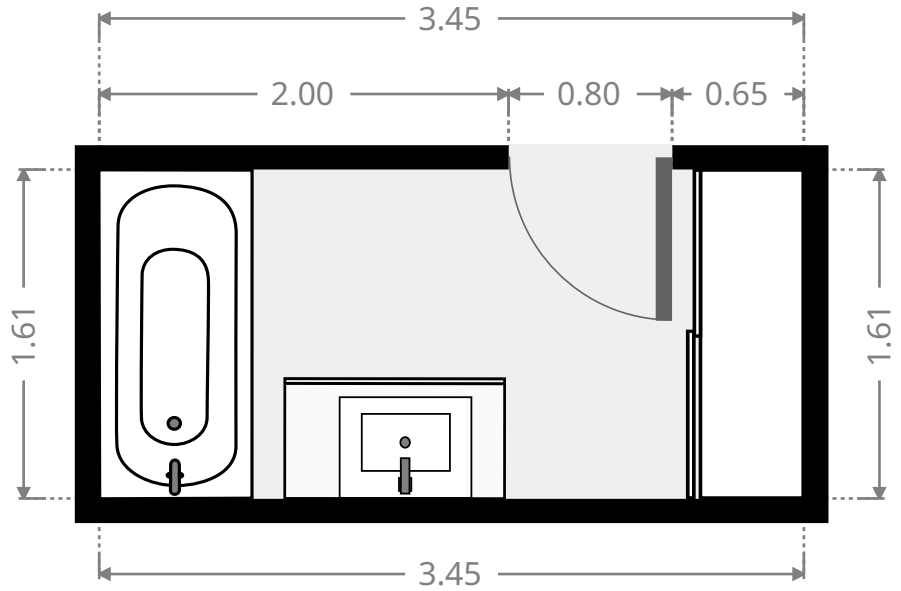
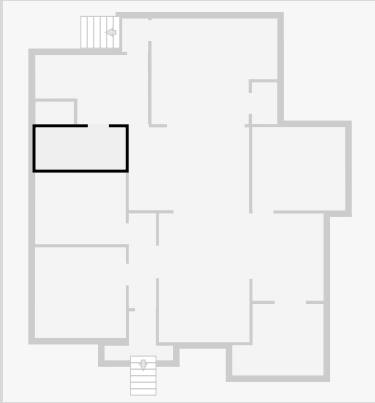

Toilet / Half Bath

Width: 0.87 m
Length: 1.48 m
Area: 1.29 m²
Perimeter: 4.70 m

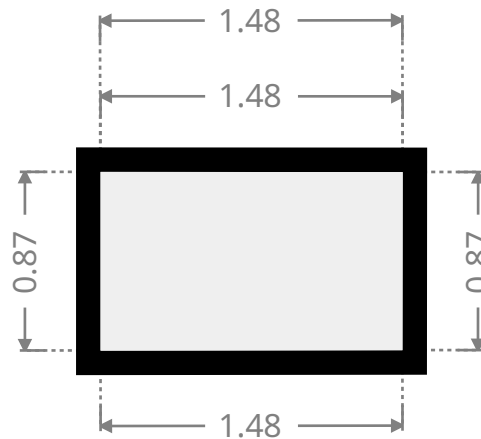

THIS FLOORPLAN IS PROVIDED WITHOUT WARRANTY OF ANY KIND. SENSOPIA DISCLAIMS ANY WARRANTY INCLUDING, WITHOUT LIMITATION, SATISFACTORY QUALITY OR ACCURACY OF DIMENSIONS.

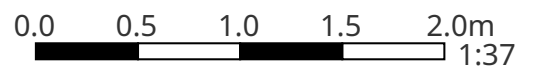

28 Rundle Street

Other

Width: 4.06 m
 Length: 4.83 m
 Area: 17.70 m²
 Perimeter: 17.77 m

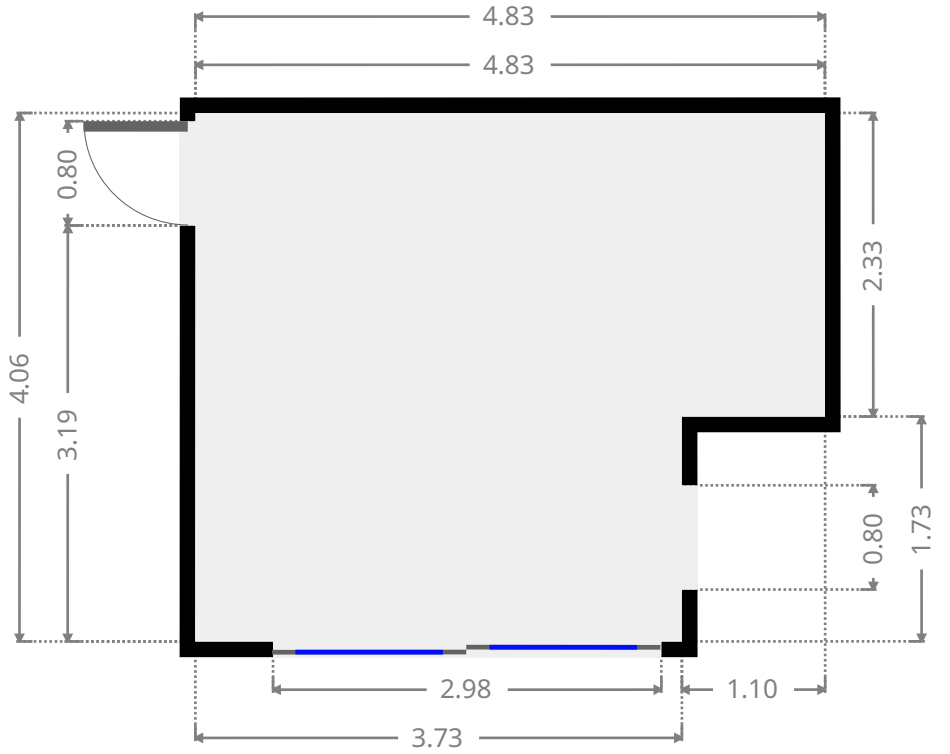
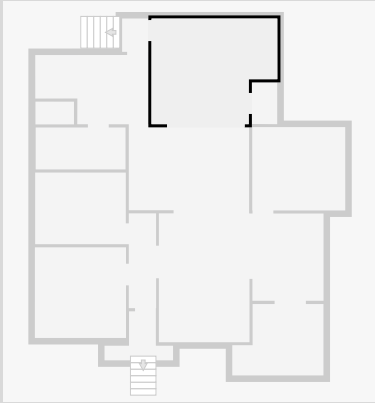

Laundry Room

Width: 0.99 m
 Length: 1.61 m
 Area: 1.55 m²
 Perimeter: 5.15 m

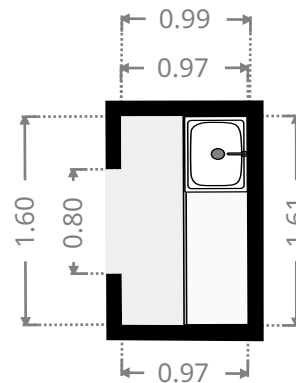
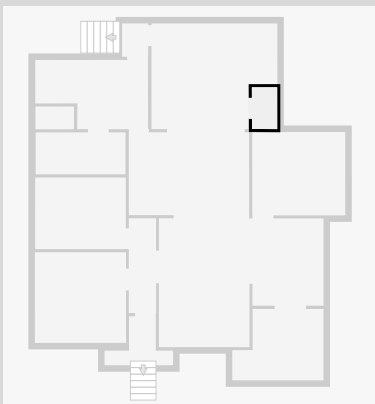

28 Rundle Street

Other

Width: 1.00 m
 Length: 1.28 m
 Area: 1.28 m²
 Perimeter: 4.56 m

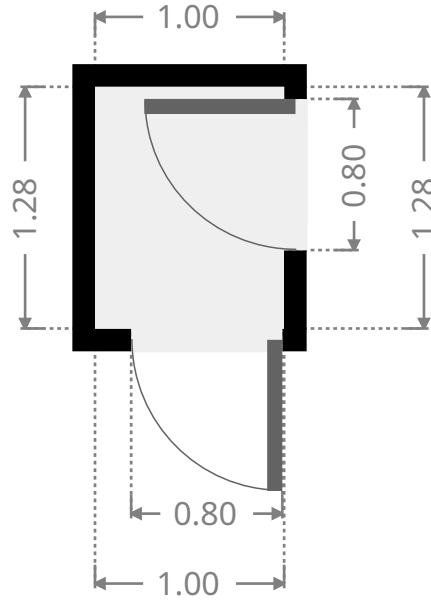
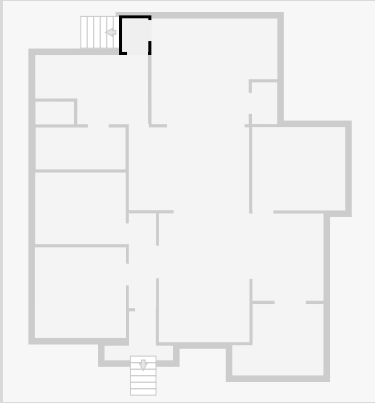

Other

Width: 2.74 m
 Length: 3.50 m
 Area: 8.36 m²
 Perimeter: 12.48 m

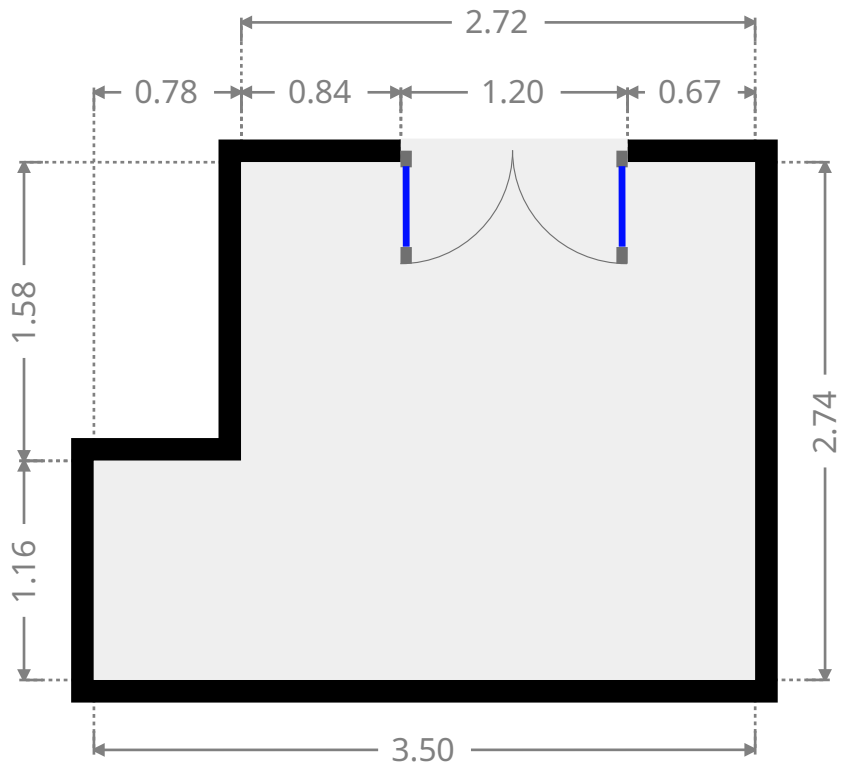
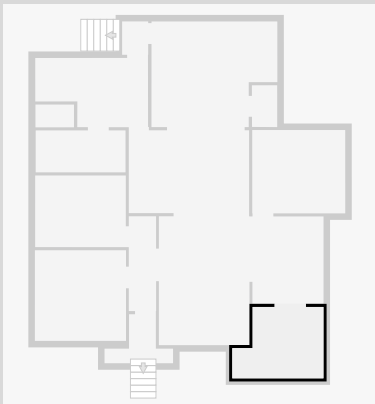

THIS FLOORPLAN IS PROVIDED WITHOUT WARRANTY OF ANY KIND. SENSOPIA DISCLAIMS ANY WARRANTY INCLUDING, WITHOUT LIMITATION, SATISFACTORY QUALITY OR ACCURACY OF DIMENSIONS.

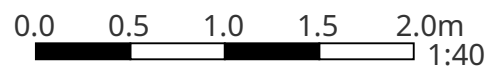

28 Rundle Street

Other

Width:	1.88 m
Length:	2.63 m
Area	2.83 m ²
Perimeter	9.02 m

