

278 Thirkettle Avenue

Ground Floor

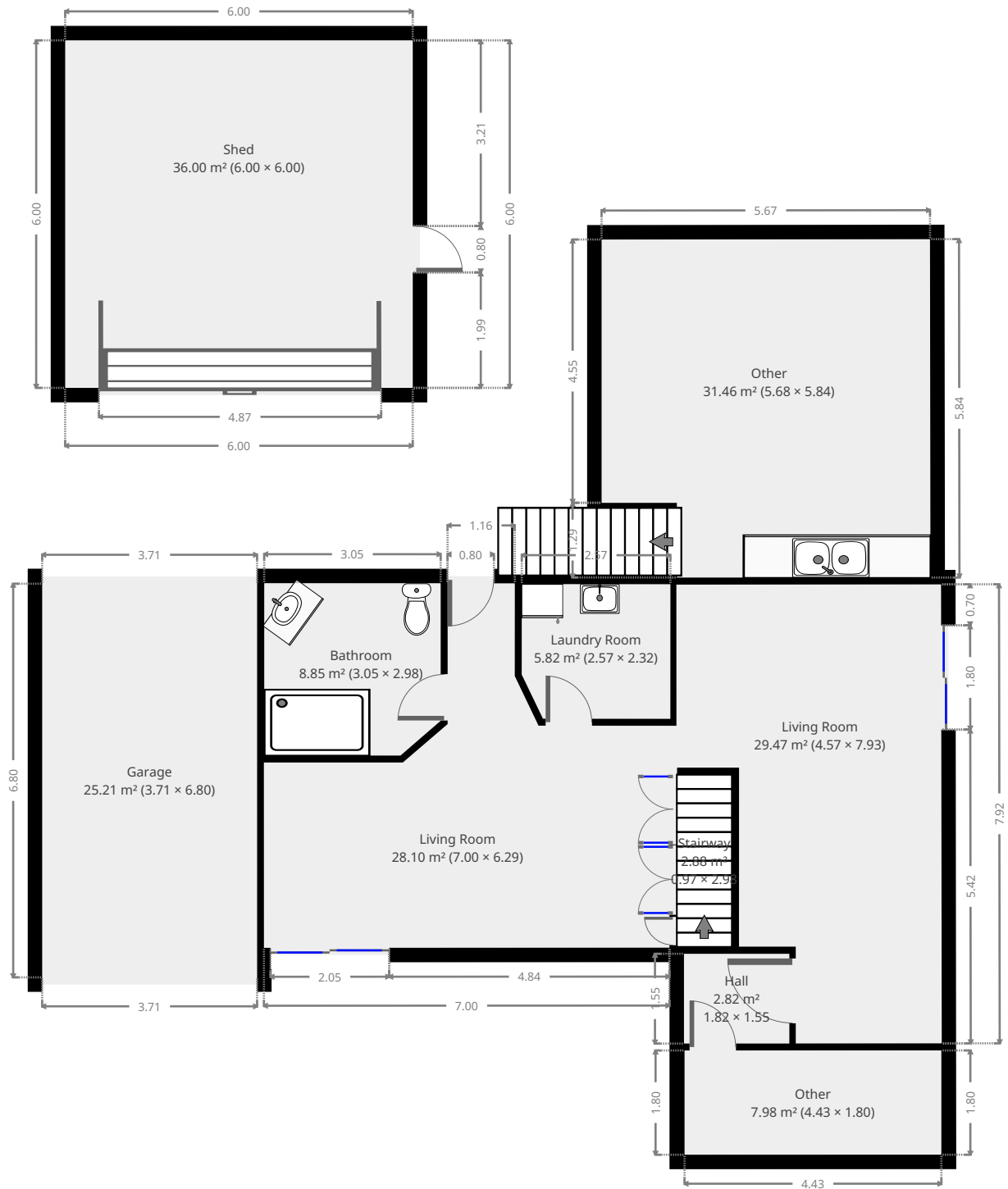

THIS FLOORPLAN IS PROVIDED WITHOUT WARRANTY OF ANY KIND. SENSOPIA DISCLAIMS ANY WARRANTY INCLUDING, WITHOUT LIMITATION, SATISFACTORY QUALITY OR ACCURACY OF DIMENSIONS.



278 Thirkettle Avenue

Hall

Width: 1.55 m
Length: 1.82 m
Area: 2.82 m²
Perimeter: 6.74 m

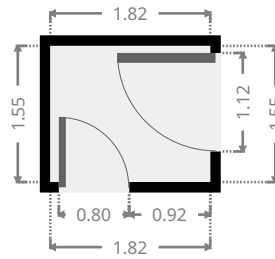
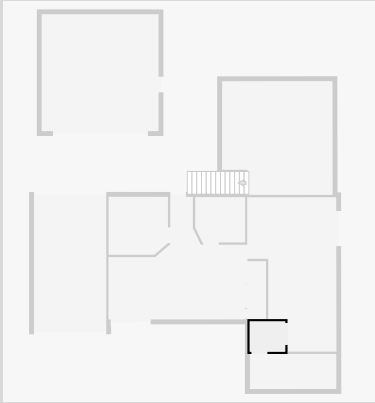

Living Room

Width: 4.57 m
Length: 7.93 m
Area: 29.47 m²
Perimeter: 25.00 m

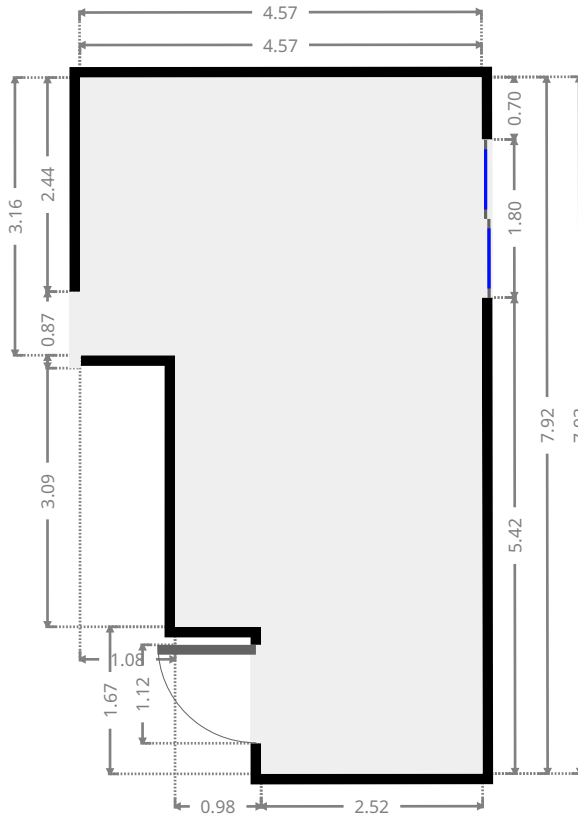
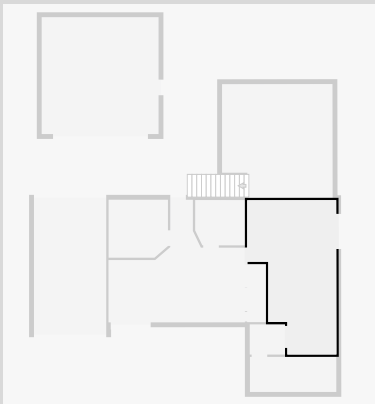

THIS FLOORPLAN IS PROVIDED WITHOUT WARRANTY OF ANY KIND. SENSOPIA DISCLAIMS ANY WARRANTY INCLUDING, WITHOUT LIMITATION, SATISFACTORY QUALITY OR ACCURACY OF DIMENSIONS.

278 Thirkettle Avenue

Living Room

Width: 6.29 m
 Length: 7.00 m
 Area: 28.10 m²
 Perimeter: 25.85 m

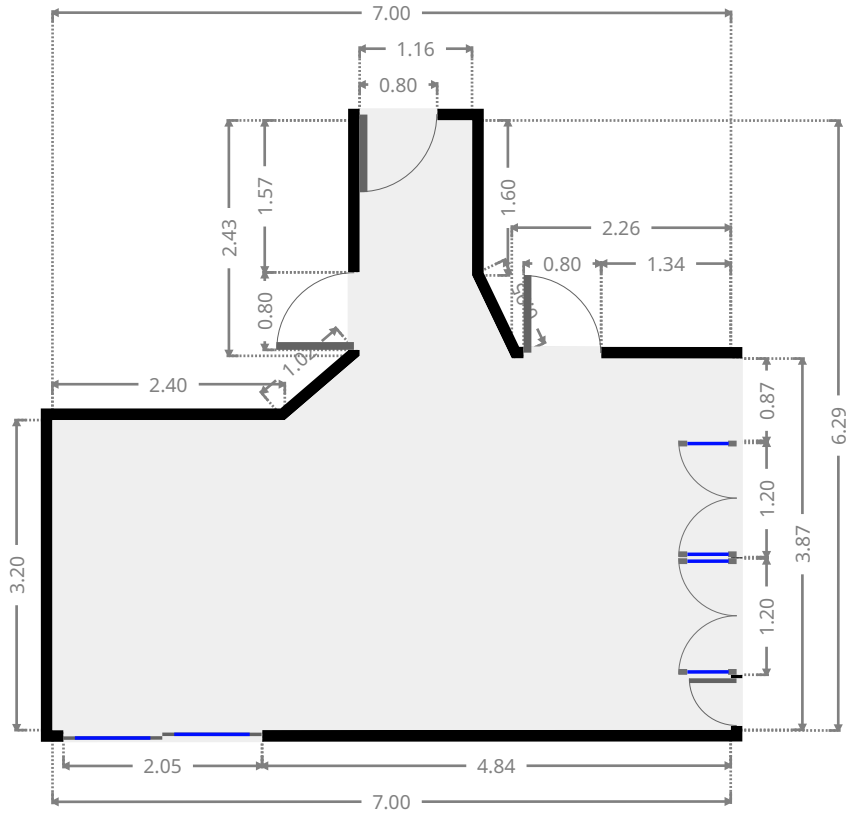
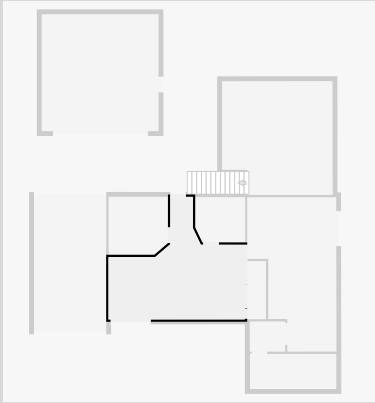

Stairway

Width: 0.97 m
 Length: 2.98 m
 Area: 2.88 m²
 Perimeter: 7.89 m

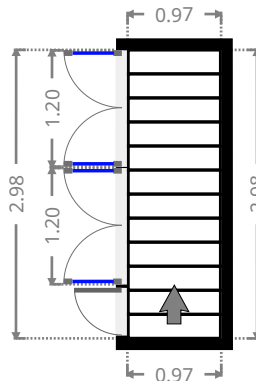
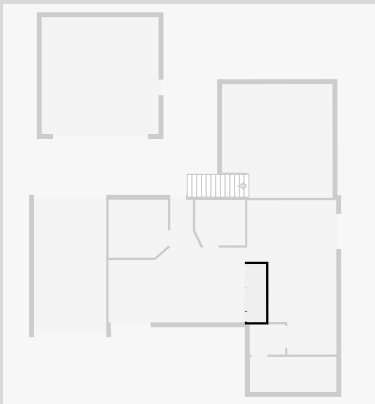

278 Thirkettle Avenue

Laundry Room

Width: 2.32 m
 Length: 2.57 m
 Area: 5.82 m²
 Perimeter: 9.50 m

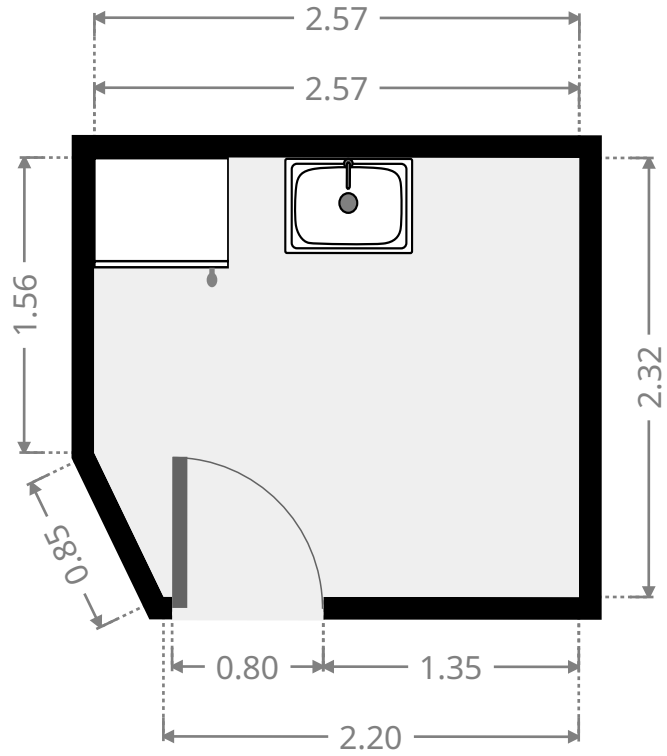
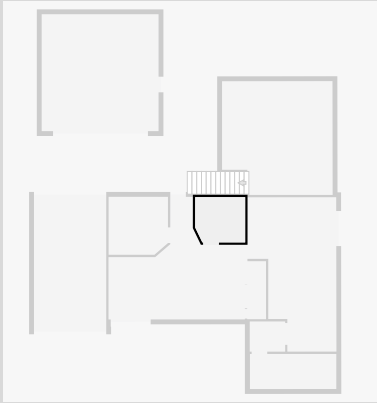

Bathroom

Width: 2.98 m
 Length: 3.05 m
 Area: 8.85 m²
 Perimeter: 11.67 m

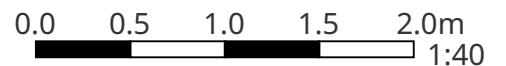
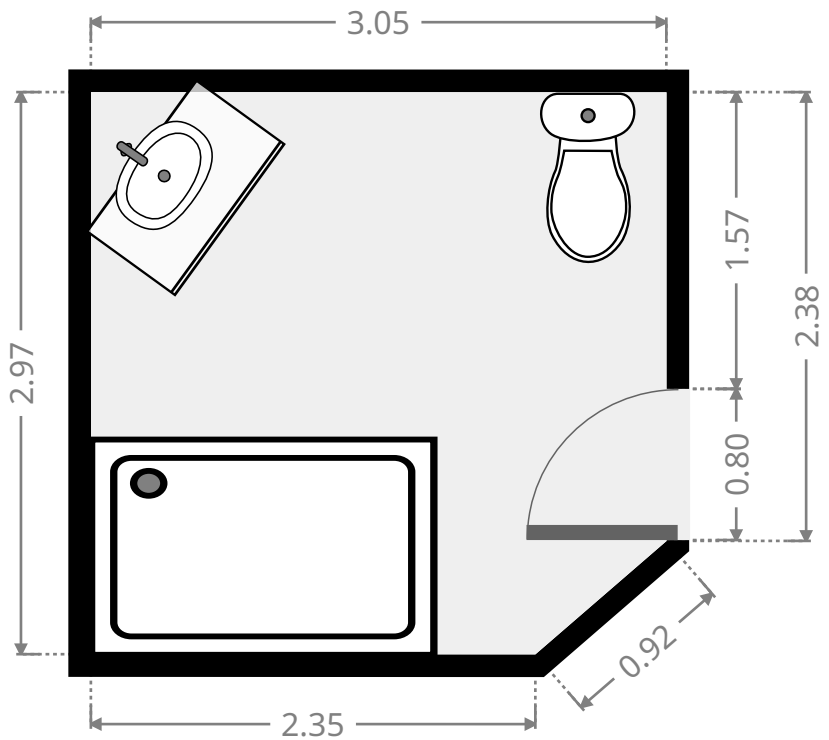
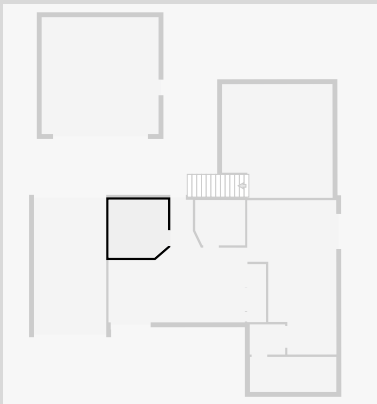

THIS FLOORPLAN IS PROVIDED WITHOUT WARRANTY OF ANY KIND. SENSOPIA DISCLAIMS ANY WARRANTY INCLUDING, WITHOUT LIMITATION, SATISFACTORY QUALITY OR ACCURACY OF DIMENSIONS.

278 Thirkettle Avenue

Other

Width: 1.80 m
 Length: 4.43 m
 Area: 7.98 m²
 Perimeter: 12.47 m

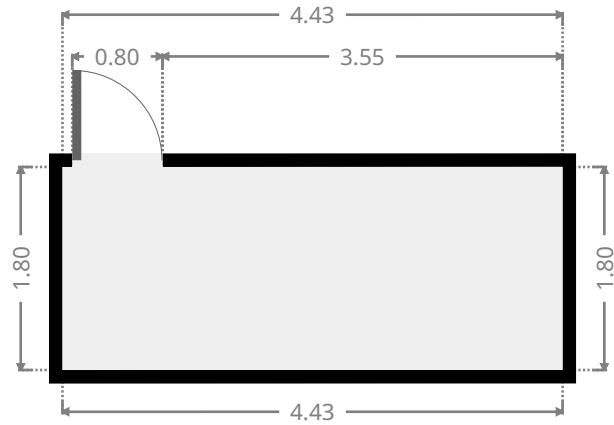
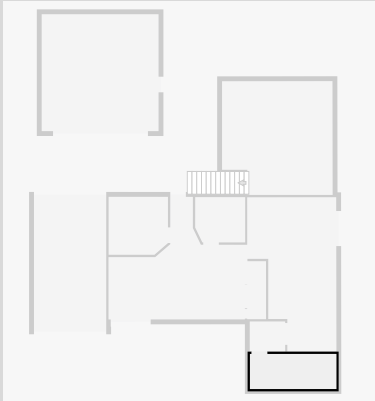

Other

Width: 5.68 m
 Length: 5.84 m
 Area: 31.46 m²
 Perimeter: 23.03 m

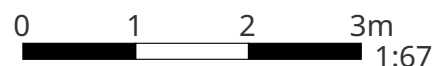
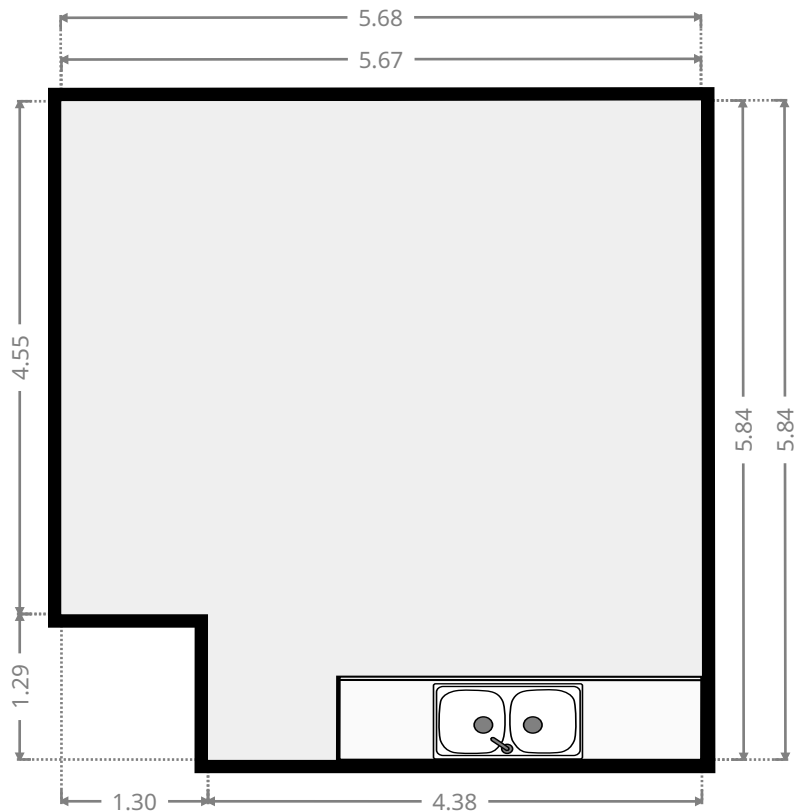
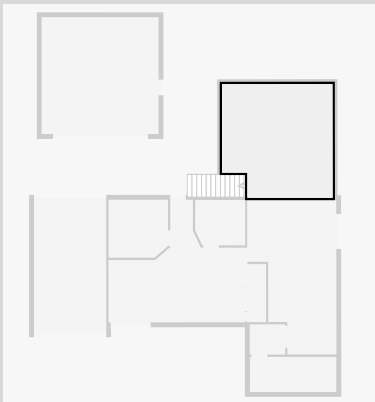

THIS FLOORPLAN IS PROVIDED WITHOUT WARRANTY OF ANY KIND. SENSOPIA DISCLAIMS ANY WARRANTY INCLUDING, WITHOUT LIMITATION, SATISFACTORY QUALITY OR ACCURACY OF DIMENSIONS.

278 Thirkettle Avenue

Garage

Width: 3.71 m
Length: 6.80 m
Area: 25.21 m²
Perimeter: 21.01 m

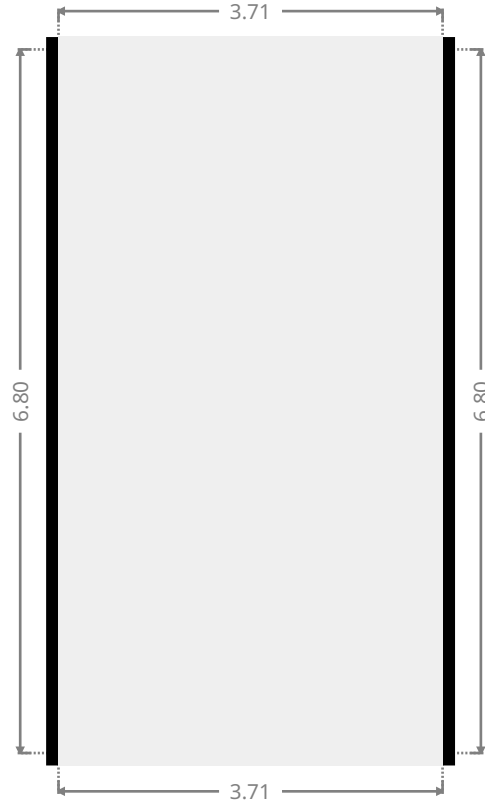
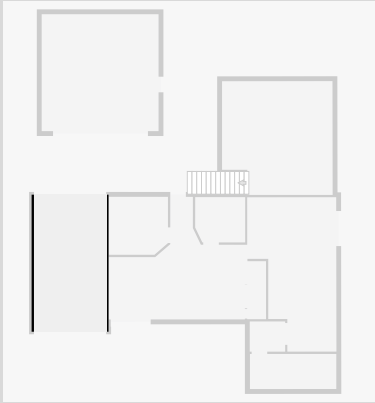

Shed

Width: 6.00 m
Length: 6.00 m
Area: 36.00 m²
Perimeter: 24.00 m

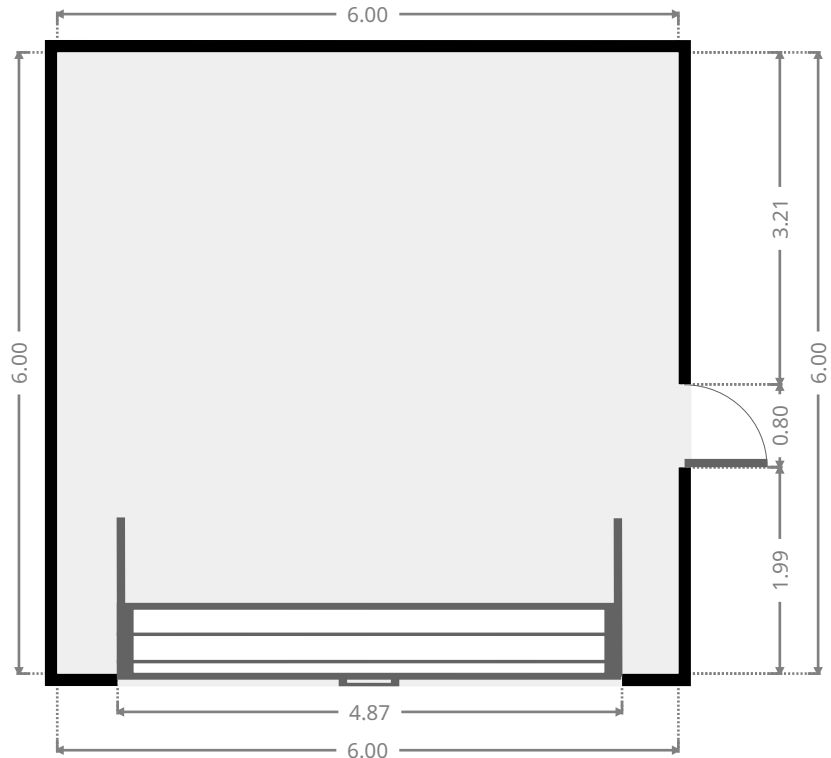
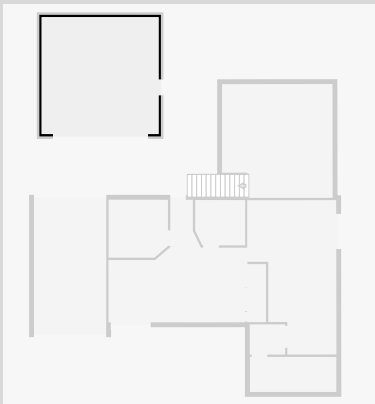

THIS FLOORPLAN IS PROVIDED WITHOUT WARRANTY OF ANY KIND. SENSOPIA DISCLAIMS ANY WARRANTY INCLUDING, WITHOUT LIMITATION, SATISFACTORY QUALITY OR ACCURACY OF DIMENSIONS.

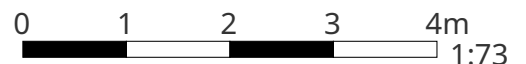

278 Thirkettle Avenue

1st Floor

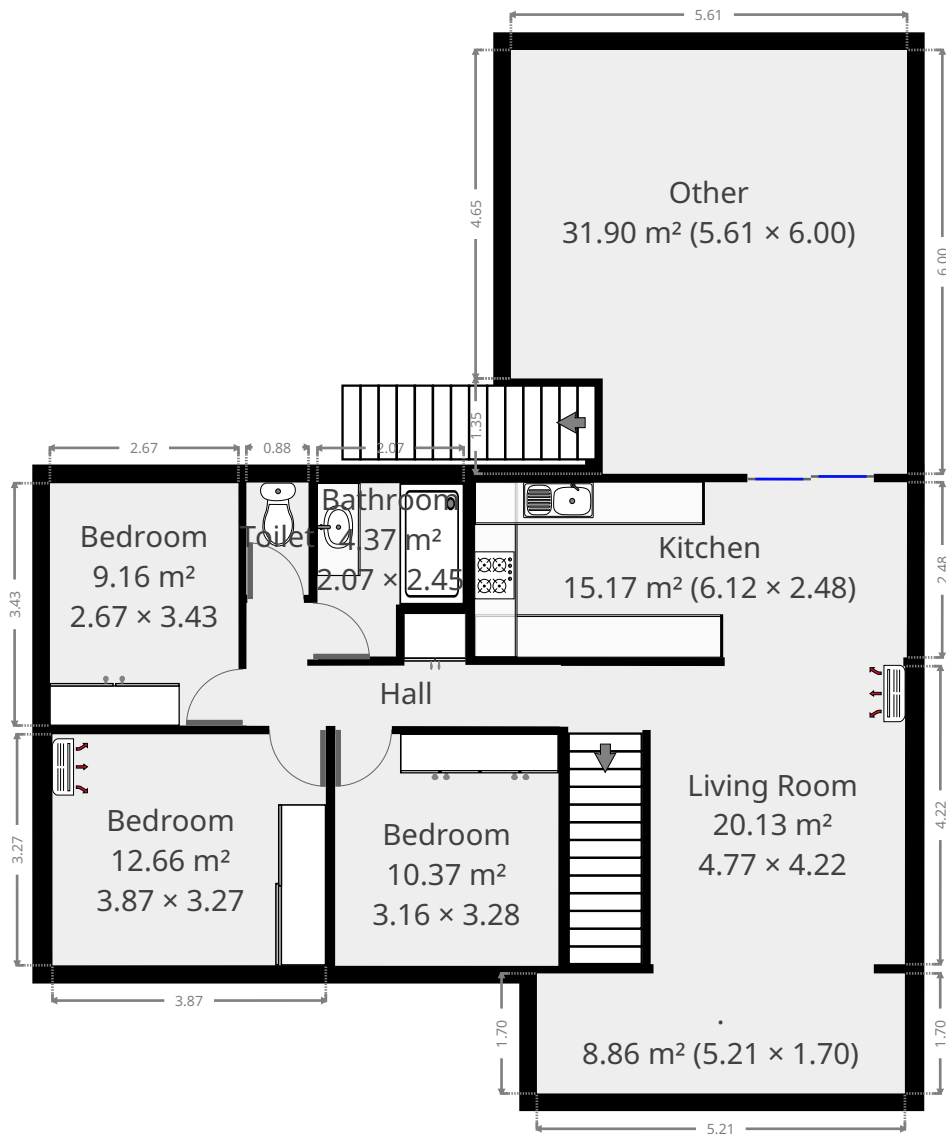

THIS FLOORPLAN IS PROVIDED WITHOUT WARRANTY OF ANY KIND. SENSOPIA DISCLAIMS ANY WARRANTY INCLUDING, WITHOUT LIMITATION, SATISFACTORY QUALITY OR ACCURACY OF DIMENSIONS.



278 Thirkettle Avenue

Width: 1.70 m
 Length: 5.21 m
 Area: 8.86 m²
 Perimeter: 13.82 m

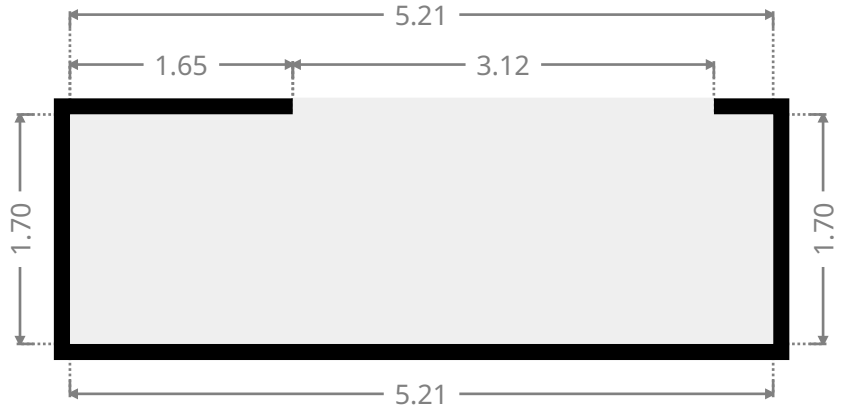
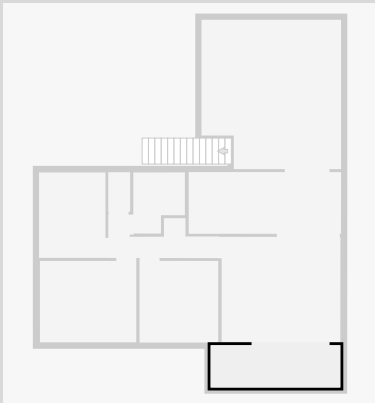

Living Room

Width: 4.22 m
 Length: 4.77 m
 Area: 20.13 m²
 Perimeter: 17.98 m

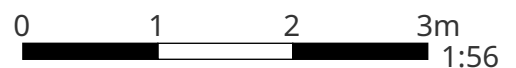
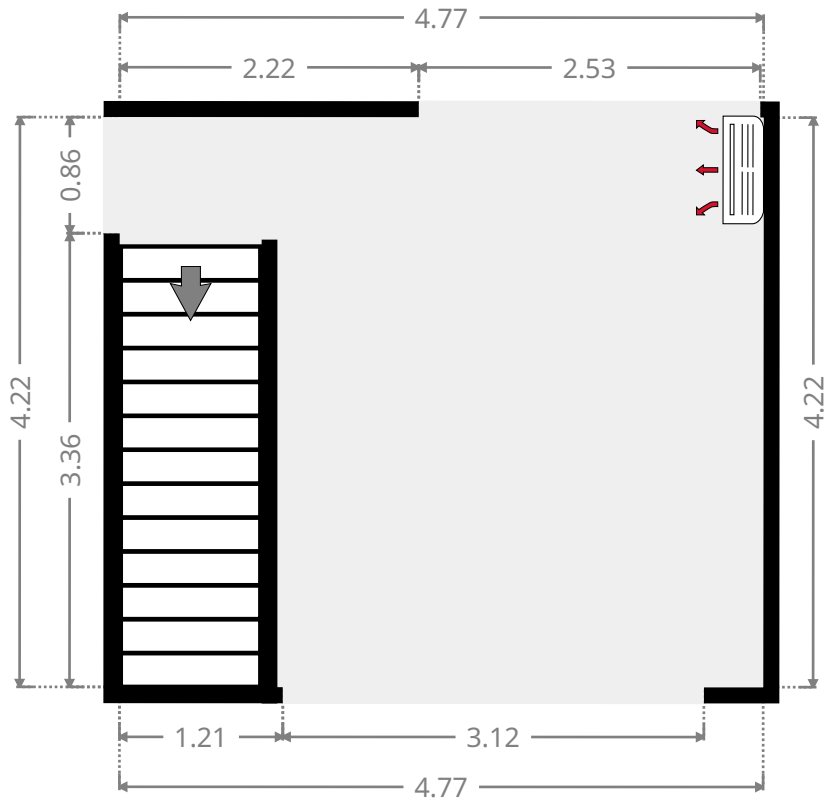
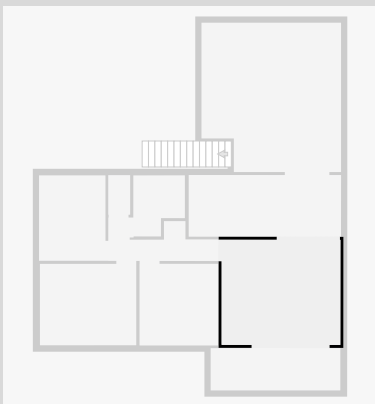

THIS FLOORPLAN IS PROVIDED WITHOUT WARRANTY OF ANY KIND. SENSOPIA DISCLAIMS ANY WARRANTY INCLUDING, WITHOUT LIMITATION, SATISFACTORY QUALITY OR ACCURACY OF DIMENSIONS.

278 Thirkettle Avenue

Kitchen

Width: 2.48 m
 Length: 6.12 m
 Area: 15.17 m²
 Perimeter: 17.20 m

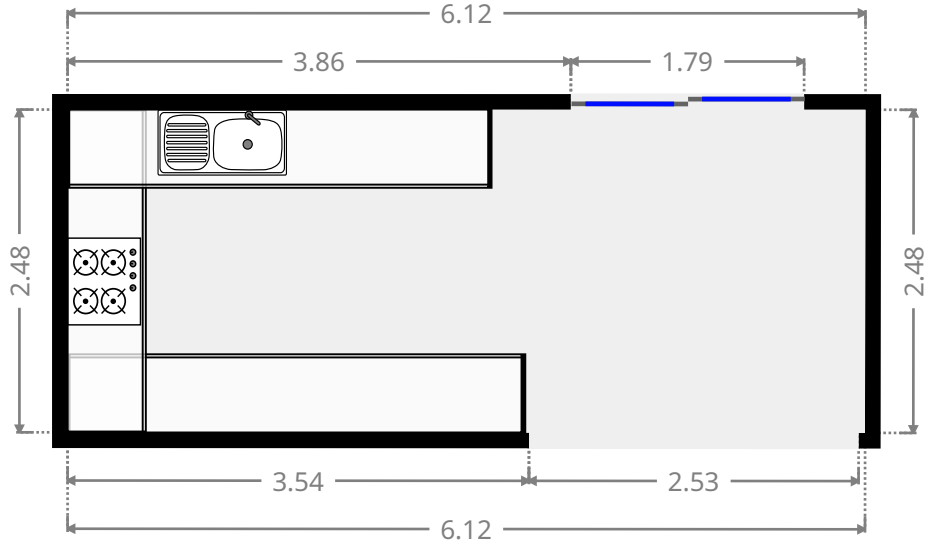
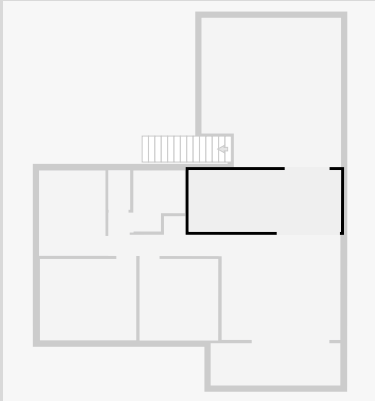

Hall

Width: 1.75 m
 Length: 4.45 m
 Area: 5.23 m²
 Perimeter: 13.88 m

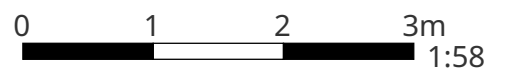
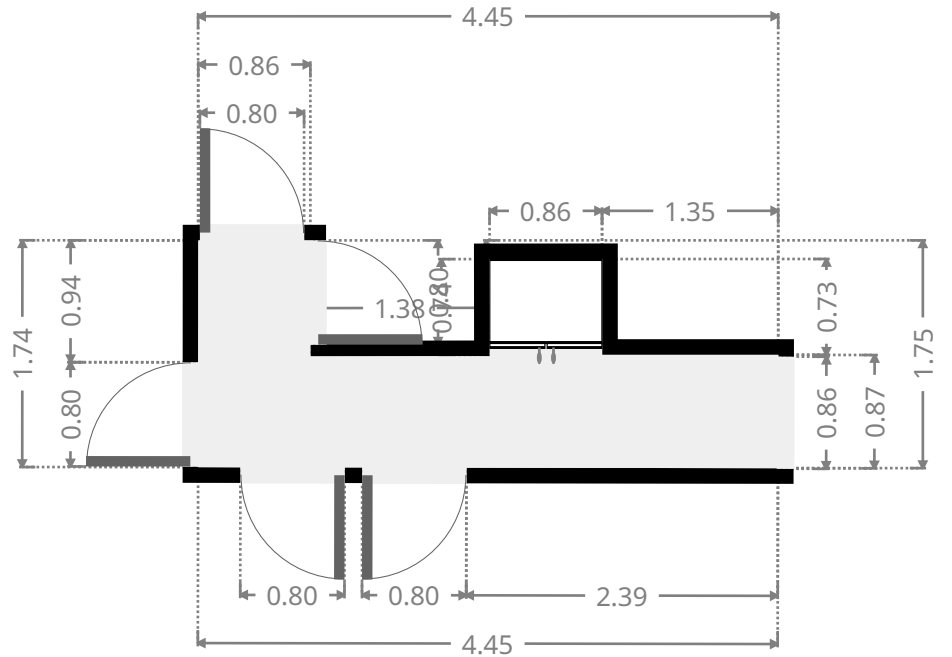
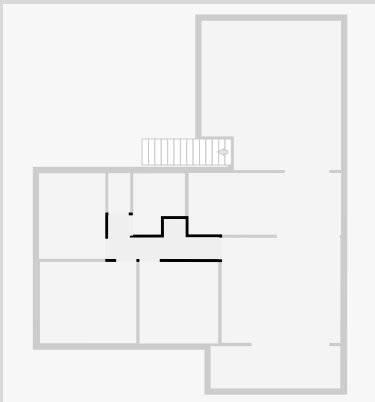

THIS FLOORPLAN IS PROVIDED WITHOUT WARRANTY OF ANY KIND. SENSOPIA DISCLAIMS ANY WARRANTY INCLUDING, WITHOUT LIMITATION, SATISFACTORY QUALITY OR ACCURACY OF DIMENSIONS.

278 Thirkettle Avenue

Bathroom

Width: 2.07 m
Length: 2.45 m
Area: 4.37 m²
Perimeter: 9.05 m

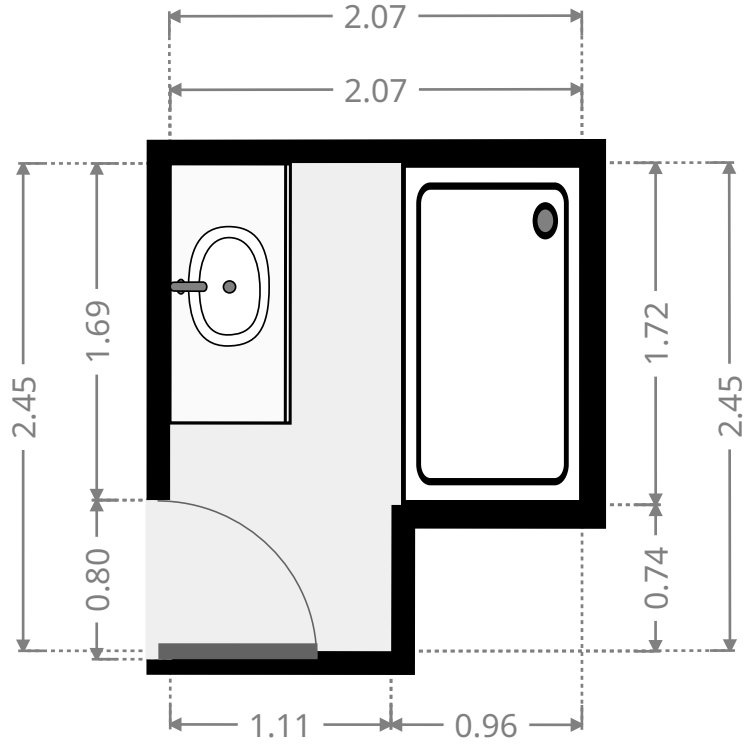
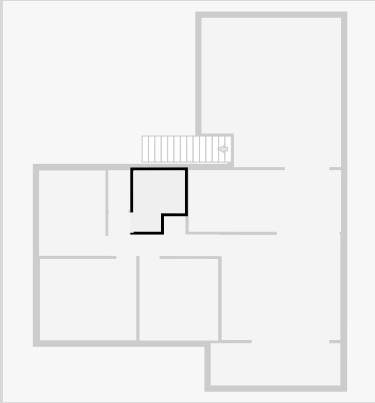

Toilet / Half Bath

Width: 0.88 m
Length: 1.59 m
Area: 1.40 m²
Perimeter: 4.94 m

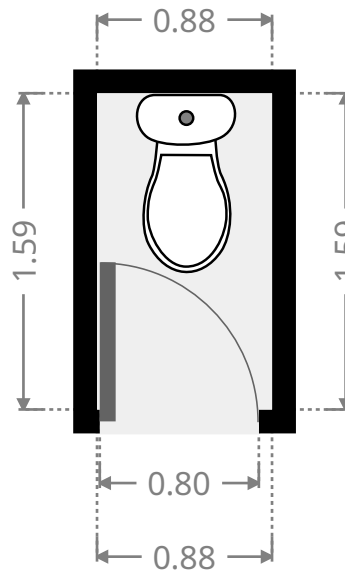
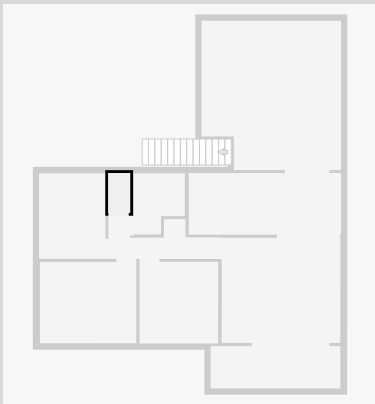

278 Thirkettle Avenue

Bedroom

Width: 3.27 m
 Length: 3.87 m
 Area: 12.66 m²
 Perimeter: 14.28 m

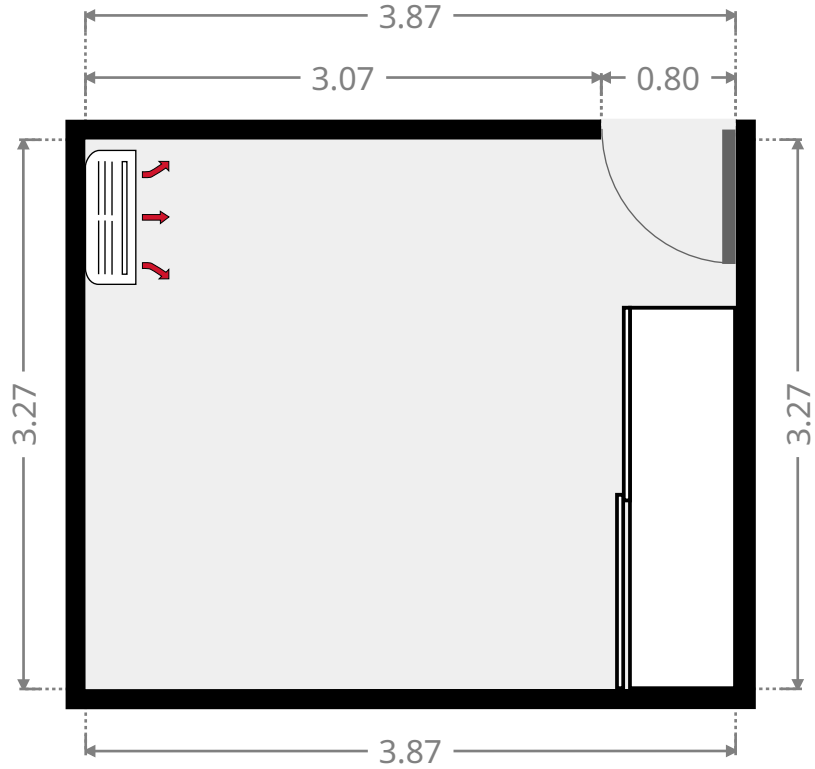
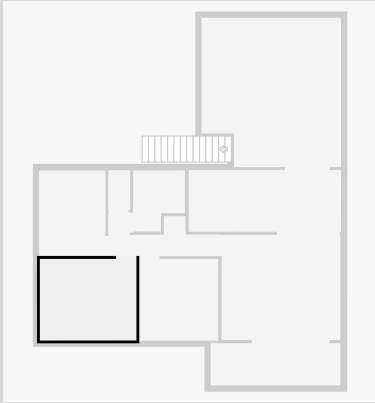

Bedroom

Width: 2.67 m
 Length: 3.43 m
 Area: 9.16 m²
 Perimeter: 12.20 m

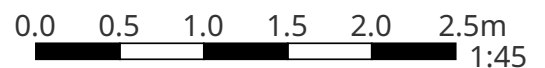
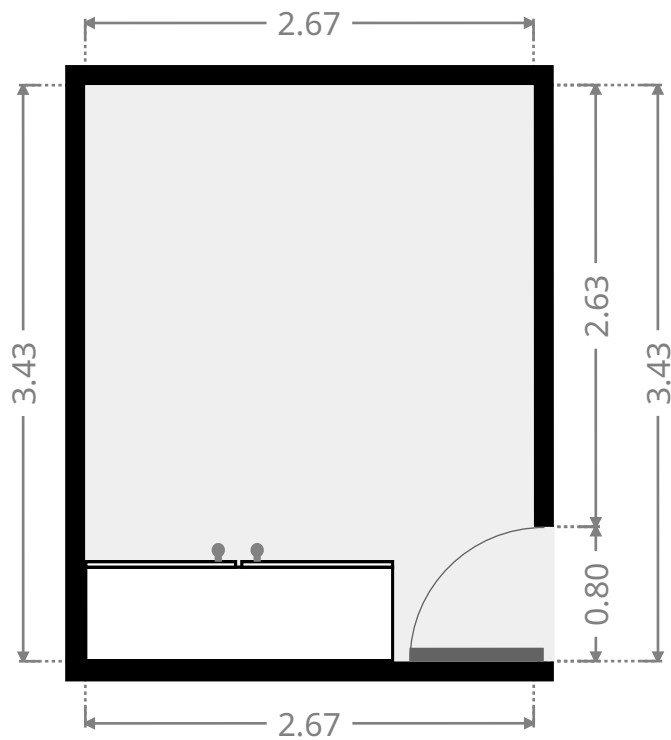
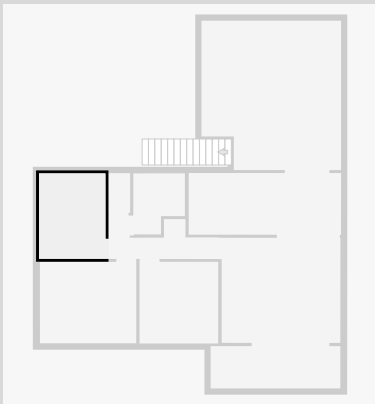

THIS FLOORPLAN IS PROVIDED WITHOUT WARRANTY OF ANY KIND. SENSOPIA DISCLAIMS ANY WARRANTY INCLUDING, WITHOUT LIMITATION, SATISFACTORY QUALITY OR ACCURACY OF DIMENSIONS.

278 Thirkettle Avenue

Bedroom

Width: 3.16 m
Length: 3.28 m
Area: 10.37 m²
Perimeter: 12.88 m

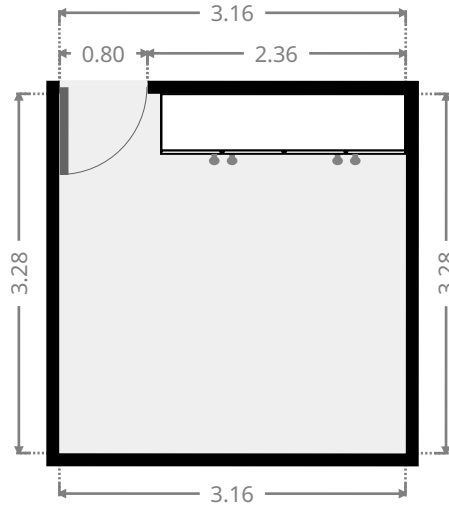
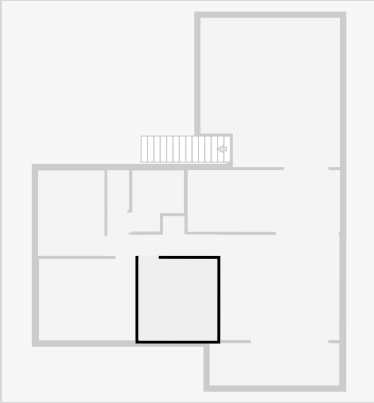

Other

Width: 5.61 m
Length: 6.00 m
Area: 31.90 m²
Perimeter: 23.22 m

