

276 Farm Street Kawana

1st Floor

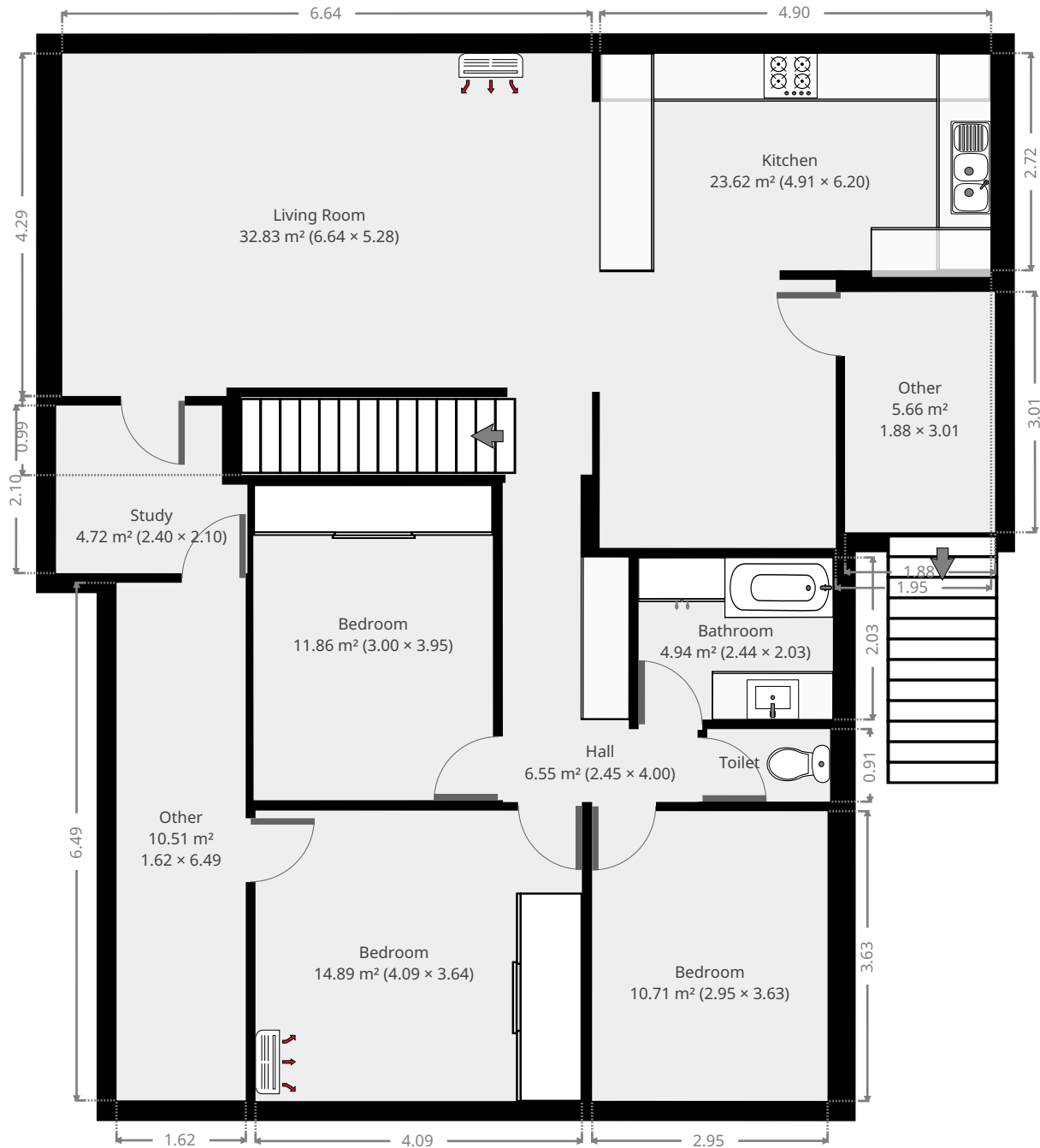

THIS FLOORPLAN IS PROVIDED WITHOUT WARRANTY OF ANY KIND. SENSOPIA DISCLAIMS ANY WARRANTY INCLUDING, WITHOUT LIMITATION, SATISFACTORY QUALITY OR ACCURACY OF DIMENSIONS.



276 Farm Street Kawana

Living Room

Width: 5.28 m
 Length: 6.64 m
 Area: 32.83 m²
 Perimeter: 23.83 m

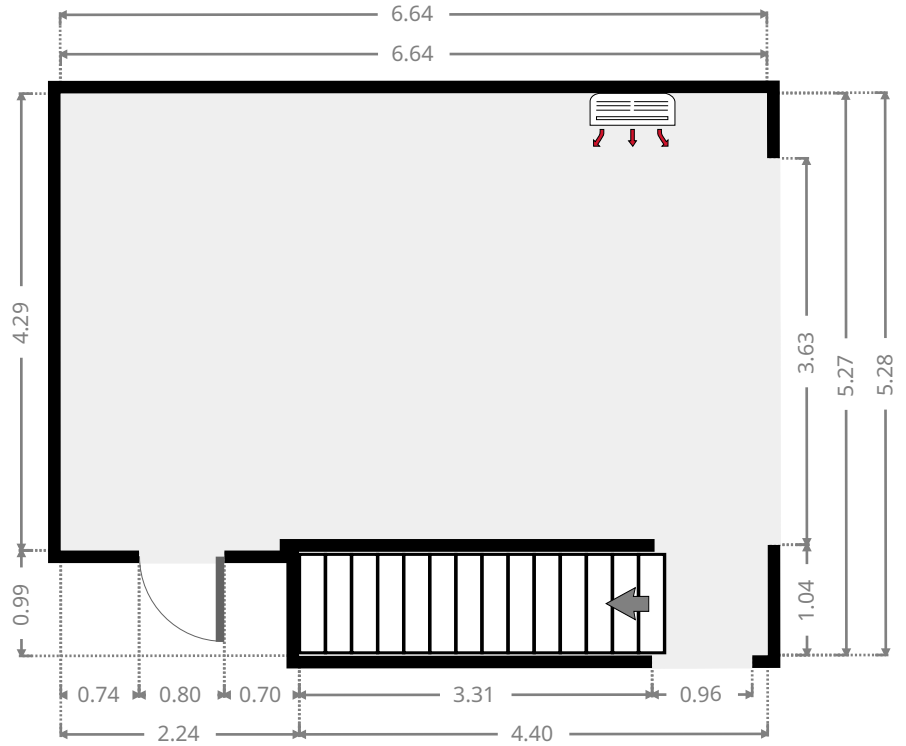
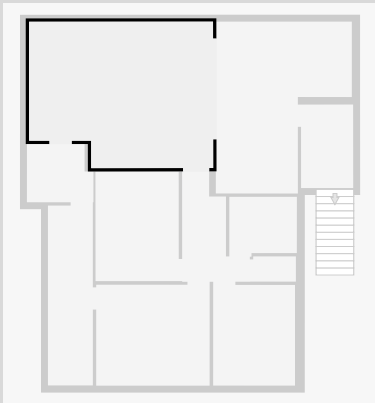

Kitchen

Width: 4.91 m
 Length: 6.20 m
 Area: 23.62 m²
 Perimeter: 22.20 m

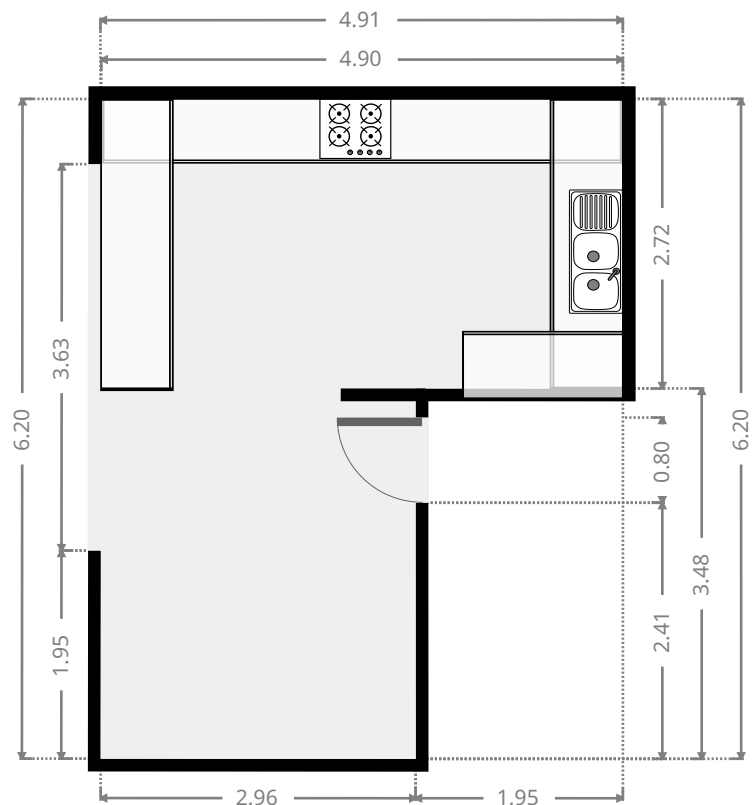
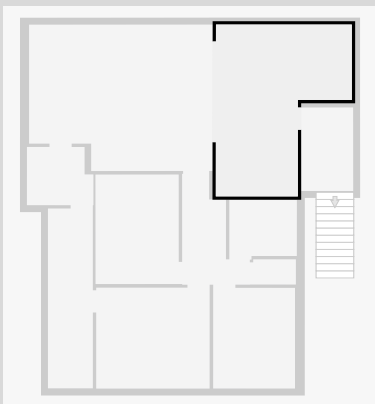

THIS FLOORPLAN IS PROVIDED WITHOUT WARRANTY OF ANY KIND. SENSOPIA DISCLAIMS ANY WARRANTY INCLUDING, WITHOUT LIMITATION, SATISFACTORY QUALITY OR ACCURACY OF DIMENSIONS.

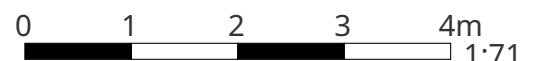

276 Farm Street Kawana

Hall

Width: 2.45 m
 Length: 4.00 m
 Area: 6.55 m²
 Perimeter: 12.88 m

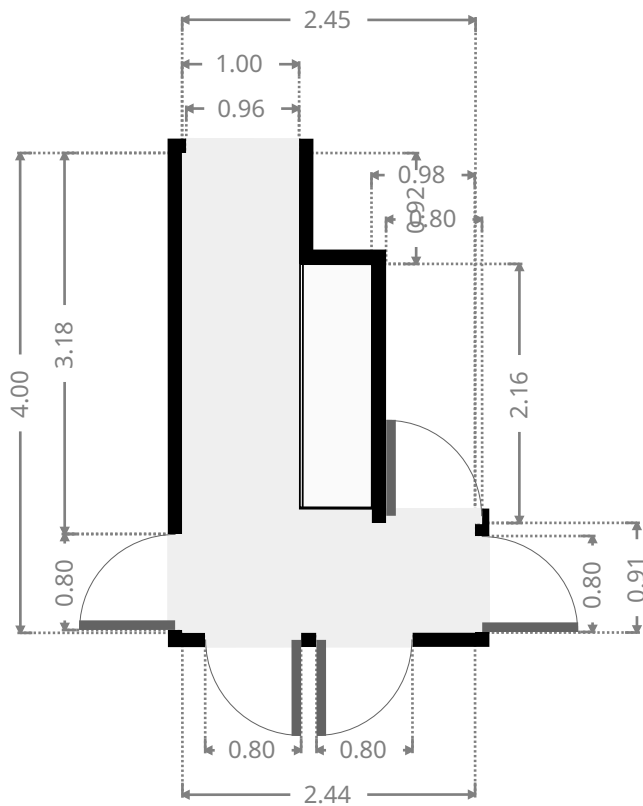
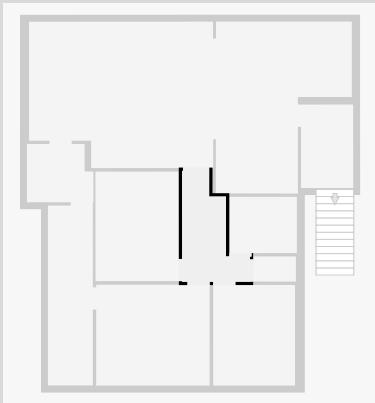

Bedroom

Width: 3.00 m
 Length: 3.95 m
 Area: 11.86 m²
 Perimeter: 13.90 m

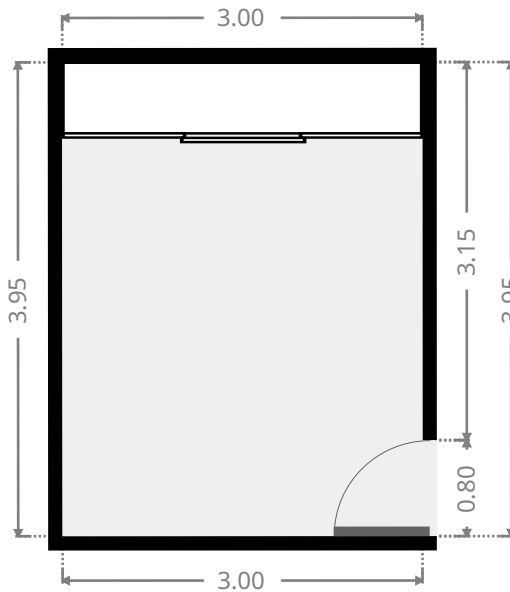
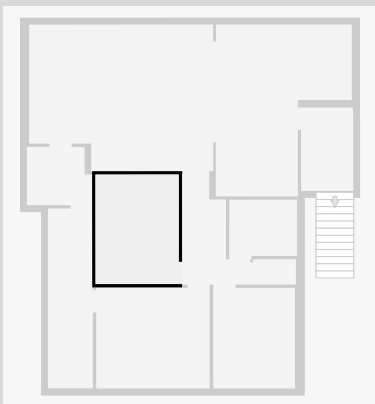

THIS FLOORPLAN IS PROVIDED WITHOUT WARRANTY OF ANY KIND. SENSOPIA DISCLAIMS ANY WARRANTY INCLUDING, WITHOUT LIMITATION, SATISFACTORY QUALITY OR ACCURACY OF DIMENSIONS.

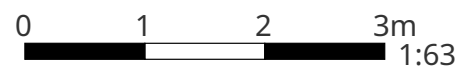

276 Farm Street Kawana

Bedroom

Width: 3.64 m
 Length: 4.09 m
 Area: 14.89 m²
 Perimeter: 15.46 m

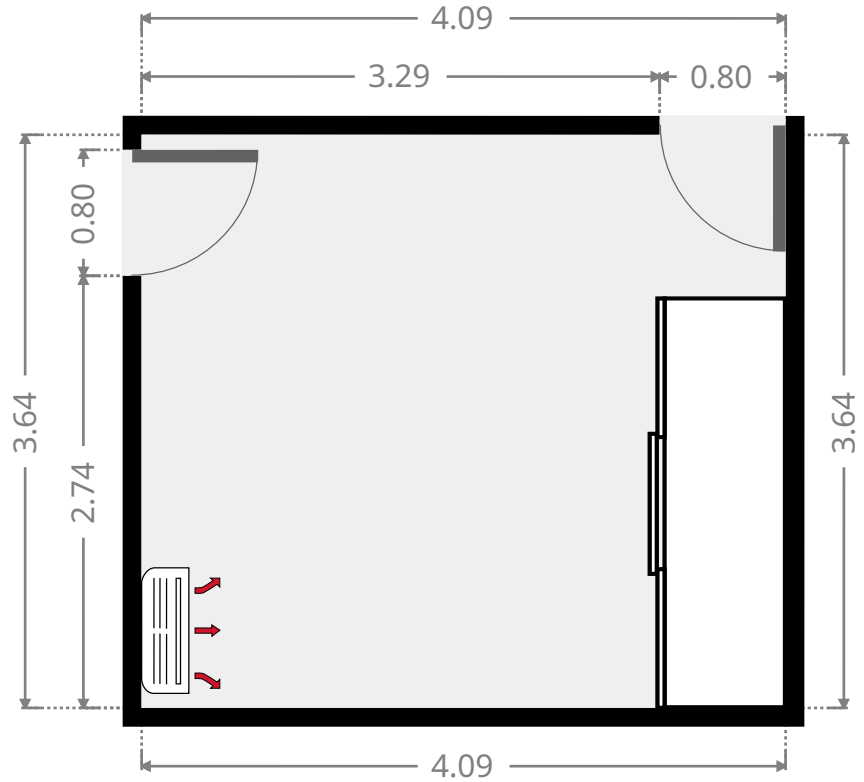
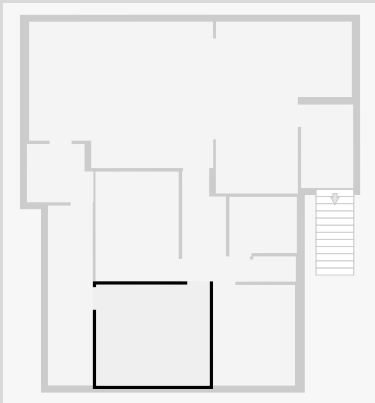

Bedroom

Width: 2.95 m
 Length: 3.63 m
 Area: 10.71 m²
 Perimeter: 13.16 m

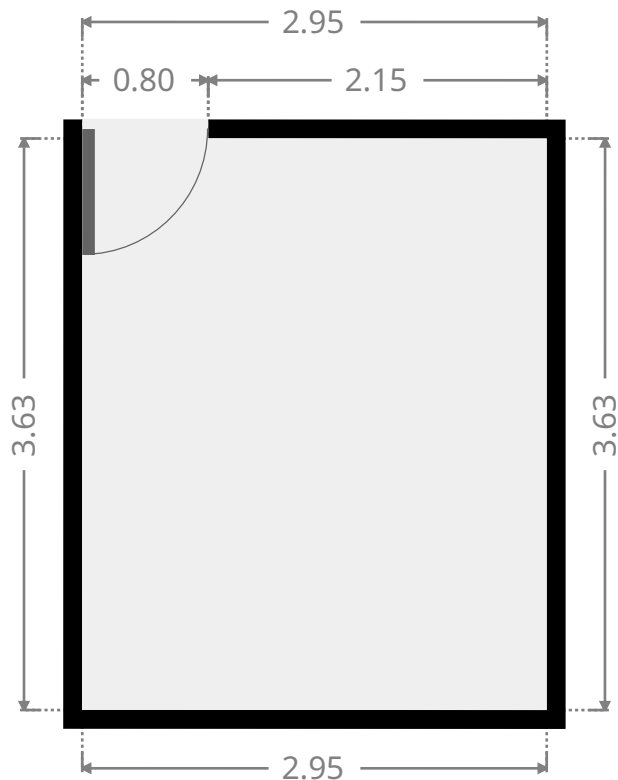
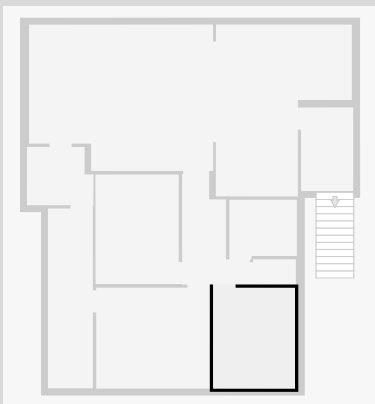

THIS FLOORPLAN IS PROVIDED WITHOUT WARRANTY OF ANY KIND. SENSOPIA DISCLAIMS ANY WARRANTY INCLUDING, WITHOUT LIMITATION, SATISFACTORY QUALITY OR ACCURACY OF DIMENSIONS.

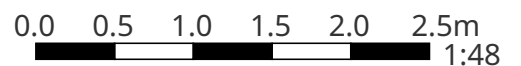

276 Farm Street Kawana

Toilet / Half Bath

Width: 0.91 m
Length: 1.54 m
Area: 1.40 m²
Perimeter: 4.90 m

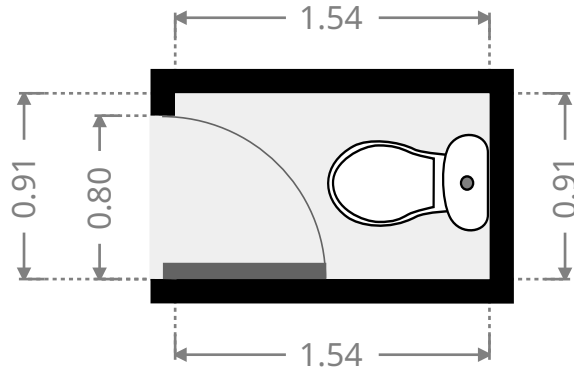
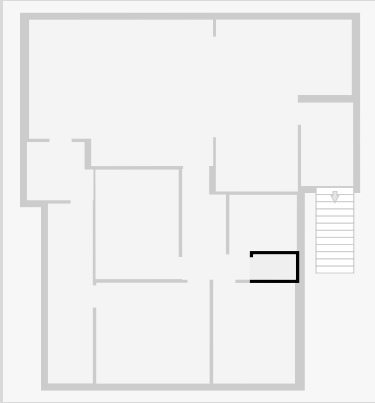

Bathroom

Width: 2.03 m
Length: 2.44 m
Area: 4.94 m²
Perimeter: 8.93 m

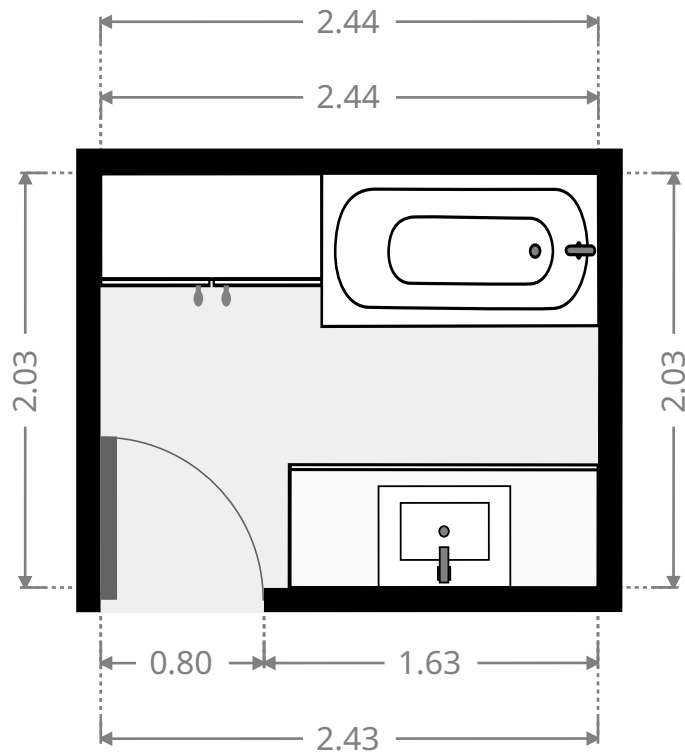
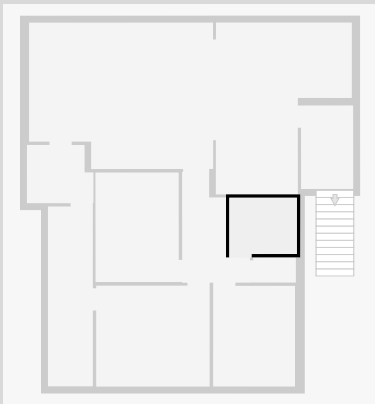

THIS FLOORPLAN IS PROVIDED WITHOUT WARRANTY OF ANY KIND. SENSOPIA DISCLAIMS ANY WARRANTY INCLUDING, WITHOUT LIMITATION, SATISFACTORY QUALITY OR ACCURACY OF DIMENSIONS.

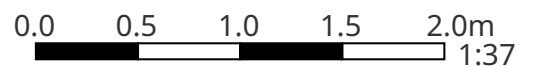

276 Farm Street Kawana

Study

Width: 2.10 m
Length: 2.40 m
Area: 4.72 m²
Perimeter: 9.00 m

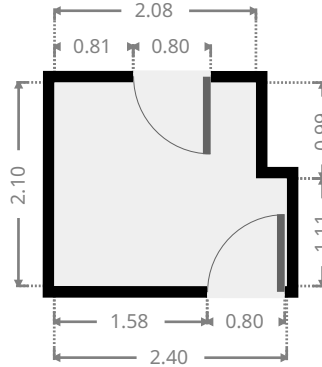
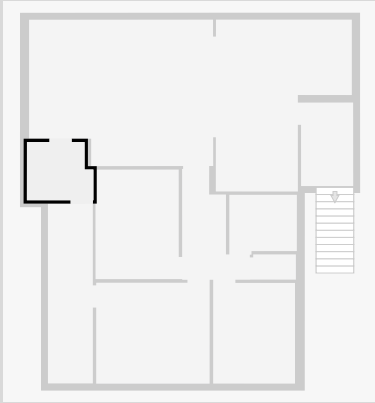

Other

Width: 1.62 m
Length: 6.49 m
Area: 10.51 m²
Perimeter: 16.21 m

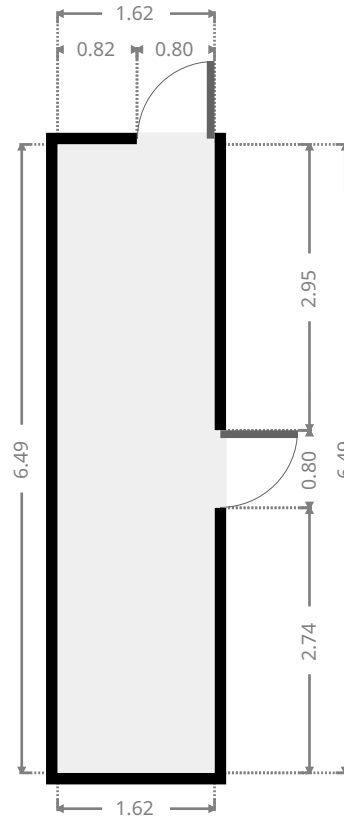
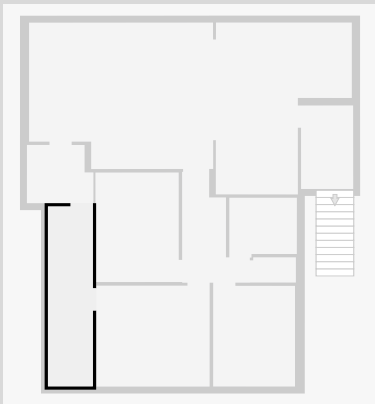

THIS FLOORPLAN IS PROVIDED WITHOUT WARRANTY OF ANY KIND. SENSOPIA DISCLAIMS ANY WARRANTY INCLUDING, WITHOUT LIMITATION, SATISFACTORY QUALITY OR ACCURACY OF DIMENSIONS.



276 Farm Street Kawana

Other

Width: 1.88 m
Length: 3.01 m
Area: 5.66 m²
Perimeter: 9.78 m

