

272 Farm Street

SUBMITTED BY

Ray White Rockhampton Casey
stockers@cqoz.com

CREATED ON

2022-02-16

Floors

2

▼ Ground Floor

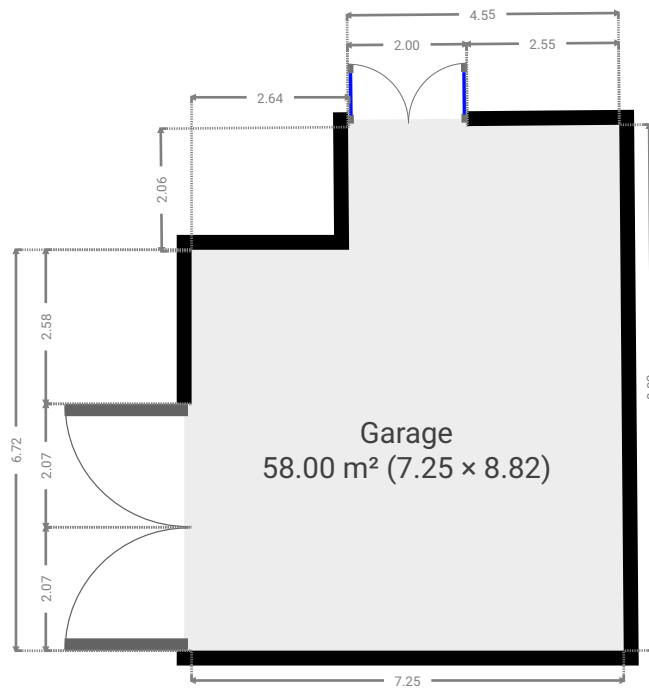

▼ **Garage**
Ground Floor

WIDTH: 8.82 m • LENGTH: 7.25 m
AREA: 58.00 m² • PERIMETER: 32.04 m

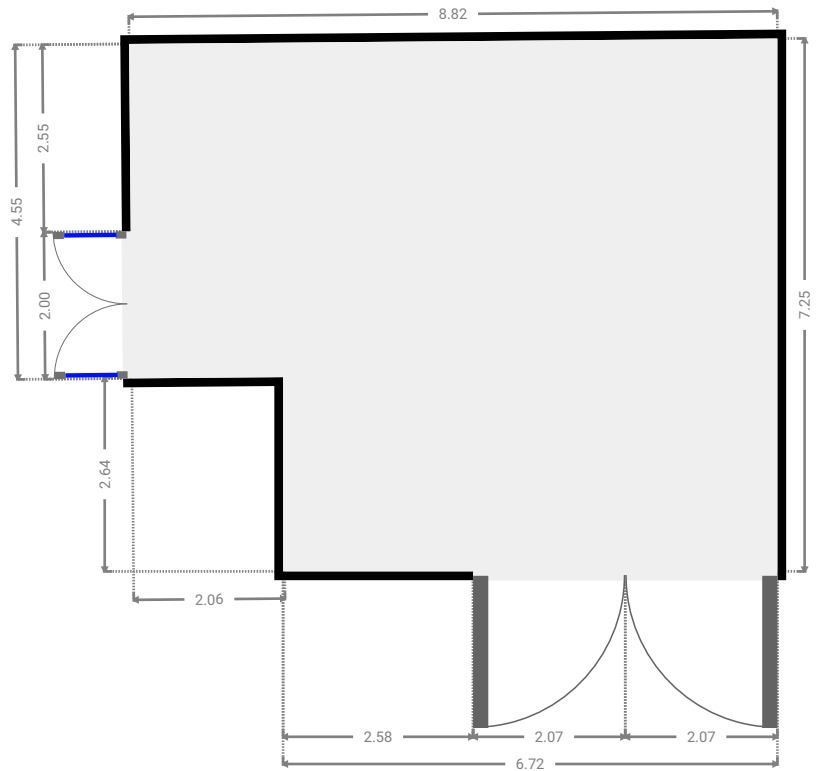
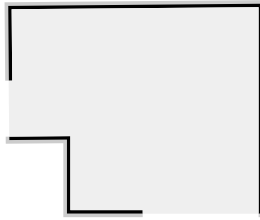

▼ 1st Floor

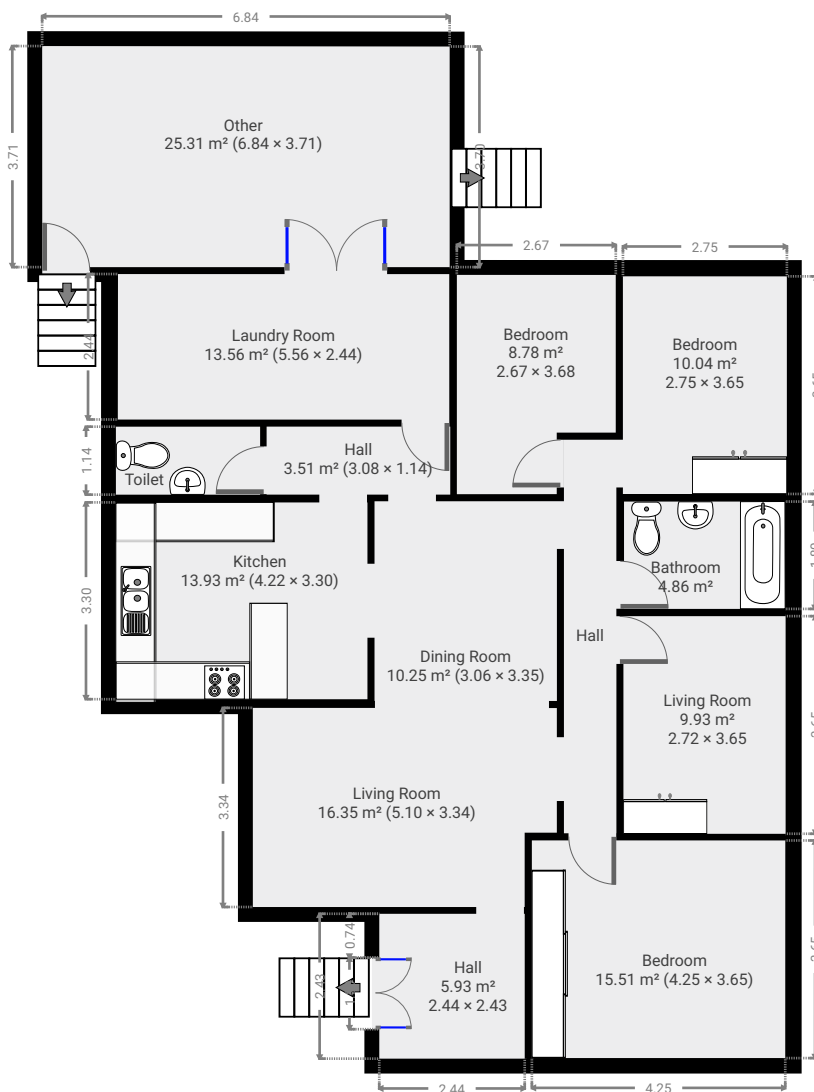
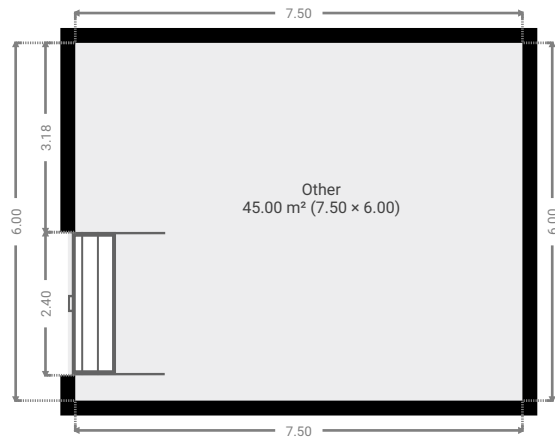

▼ Hall
1st Floor

WIDTH: 2.44 m • LENGTH: 2.43 m
AREA: 5.93 m² • PERIMETER: 9.74 m

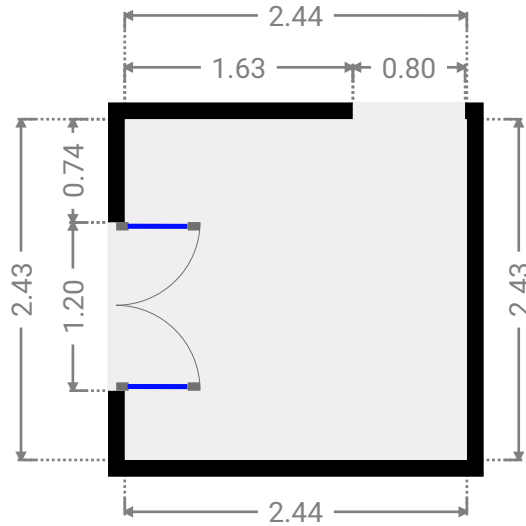

▼ Living Room
1st Floor

WIDTH: 5.10 m • LENGTH: 3.34 m
AREA: 16.35 m² • PERIMETER: 16.88 m

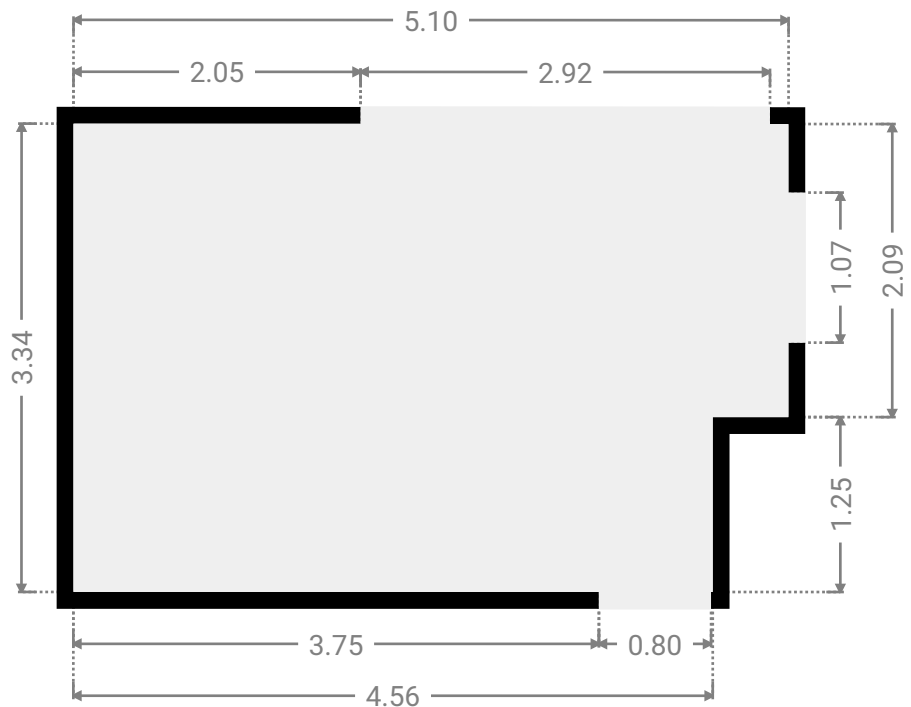

▼ Dining Room
1st Floor

WIDTH: 3.06 m • LENGTH: 3.35 m
AREA: 10.25 m² • PERIMETER: 12.82 m

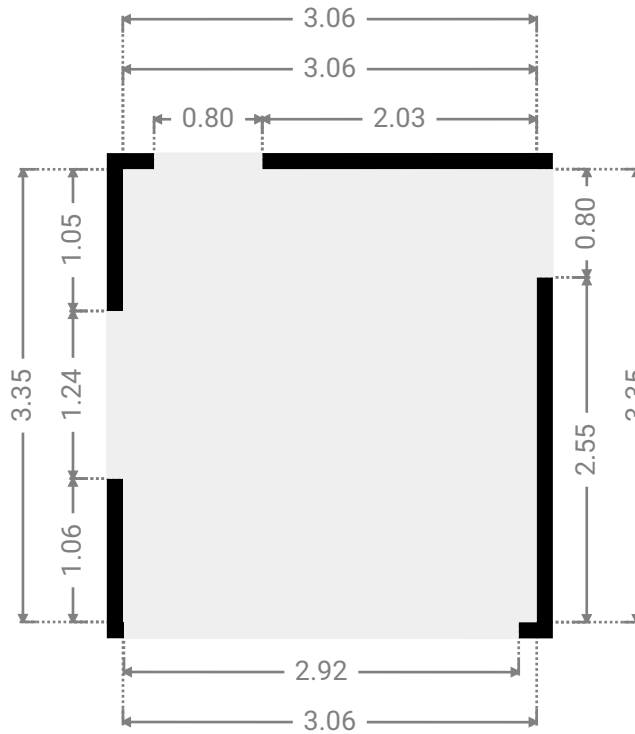
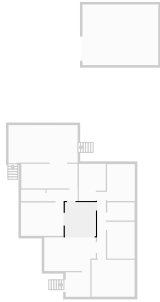

▼ Kitchen
1st Floor

WIDTH: 4.22 m • LENGTH: 3.30 m
AREA: 13.93 m² • PERIMETER: 15.04 m

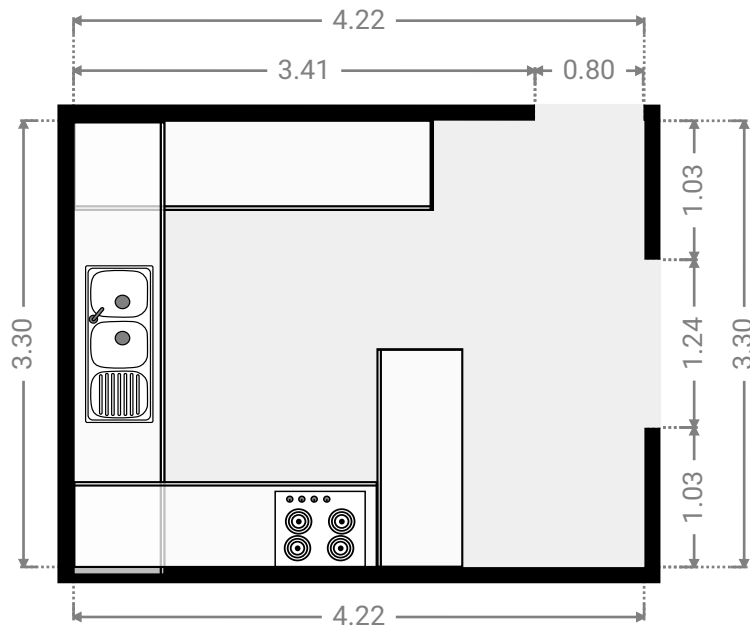
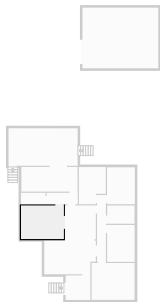

▼ **Toilet**
1st Floor

WIDTH: 2.42 m • LENGTH: 1.14 m
AREA: 2.76 m² • PERIMETER: 7.12 m

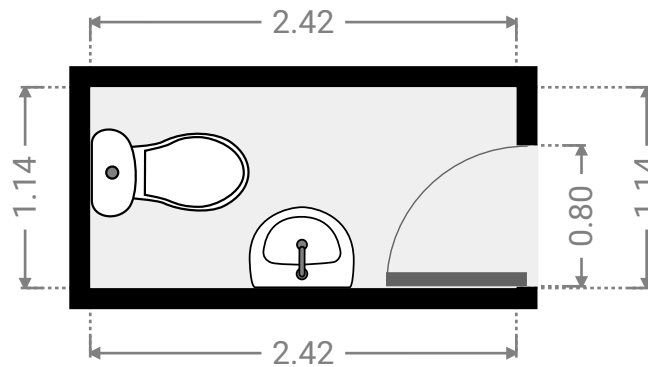

▼ **Hall**
1st Floor

WIDTH: 3.08 m • LENGTH: 1.14 m
AREA: 3.51 m² • PERIMETER: 8.44 m

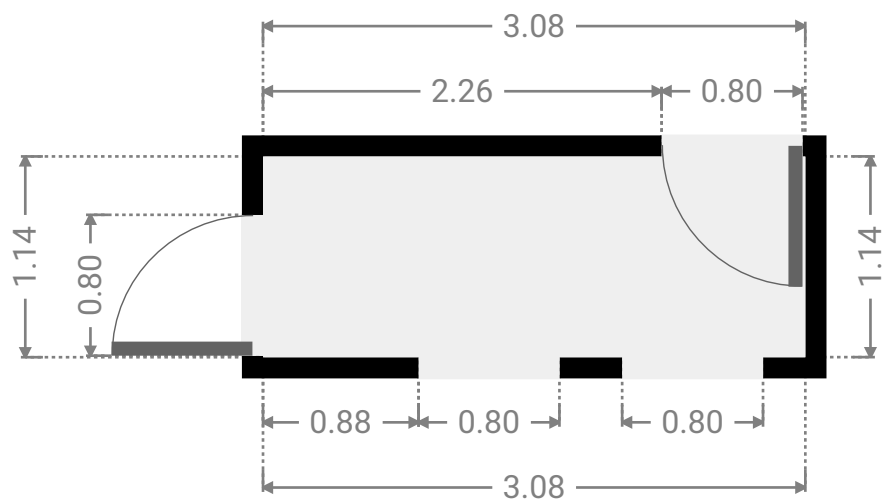

▼ **Hall**
1st Floor

WIDTH: 0.88 m • LENGTH: 6.60 m
AREA: 5.81 m² • PERIMETER: 14.96 m

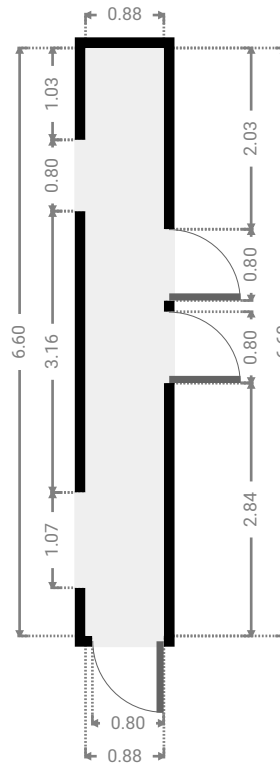
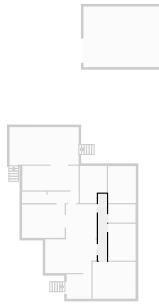

▼ **Bedroom**
1st Floor

WIDTH: 4.25 m • LENGTH: 3.65 m
AREA: 15.51 m² • PERIMETER: 15.80 m

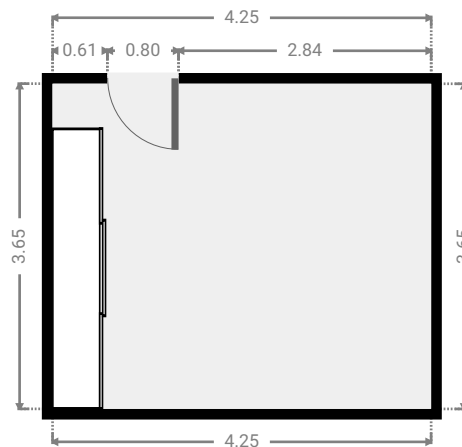

▼ **Living Room**
1st Floor

WIDTH: 2.72 m • LENGTH: 3.65 m
AREA: 9.93 m² • PERIMETER: 12.74 m

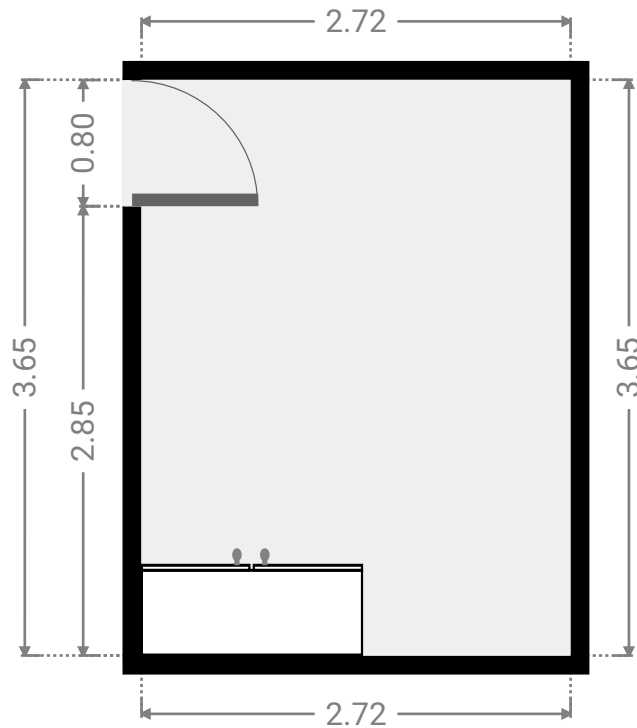

▼ **Bathroom**
1st Floor

WIDTH: 2.70 m • LENGTH: 1.80 m
AREA: 4.86 m² • PERIMETER: 9.00 m

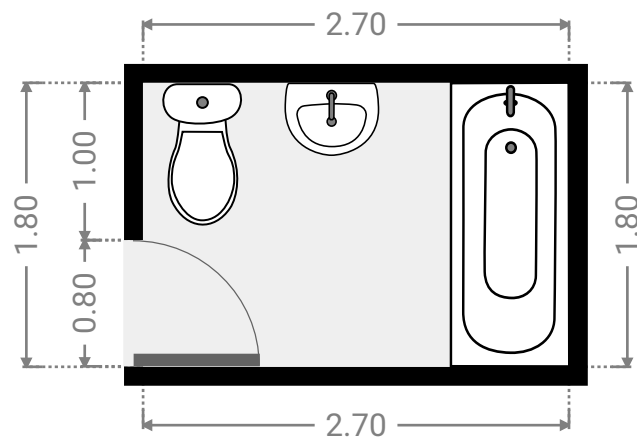

▼ **Bedroom**
1st Floor

WIDTH: 2.75 m • LENGTH: 3.65 m
AREA: 10.04 m² • PERIMETER: 12.80 m

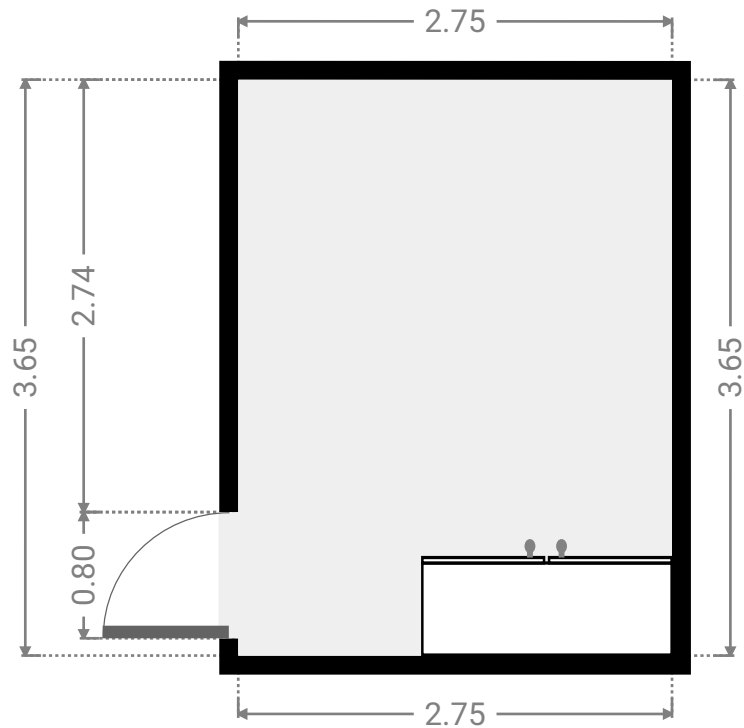
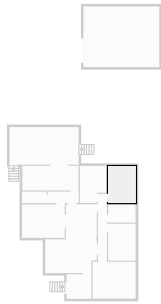

▼ **Bedroom**
1st Floor

WIDTH: 2.67 m • LENGTH: 3.68 m
AREA: 8.78 m² • PERIMETER: 12.69 m

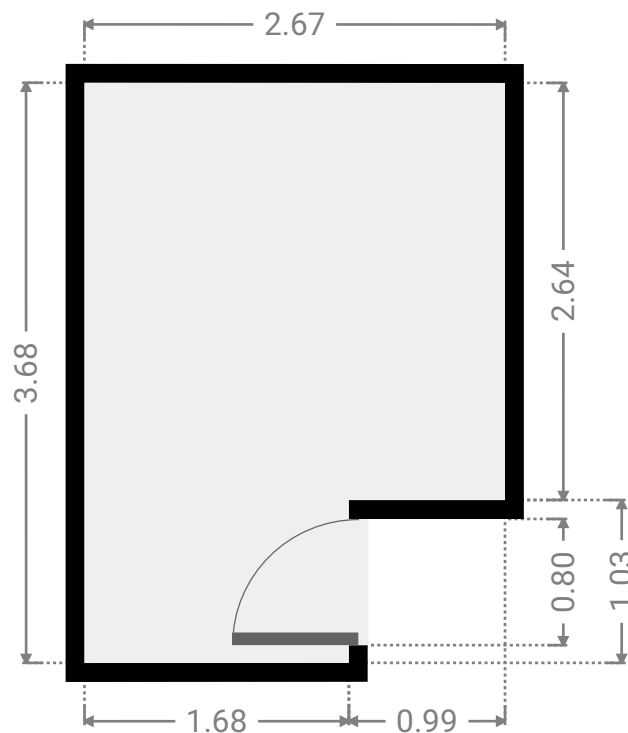
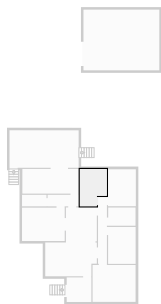

▼ Laundry Room
1st Floor

WIDTH: 5.56 m • LENGTH: 2.44 m
AREA: 13.56 m² • PERIMETER: 16.00 m

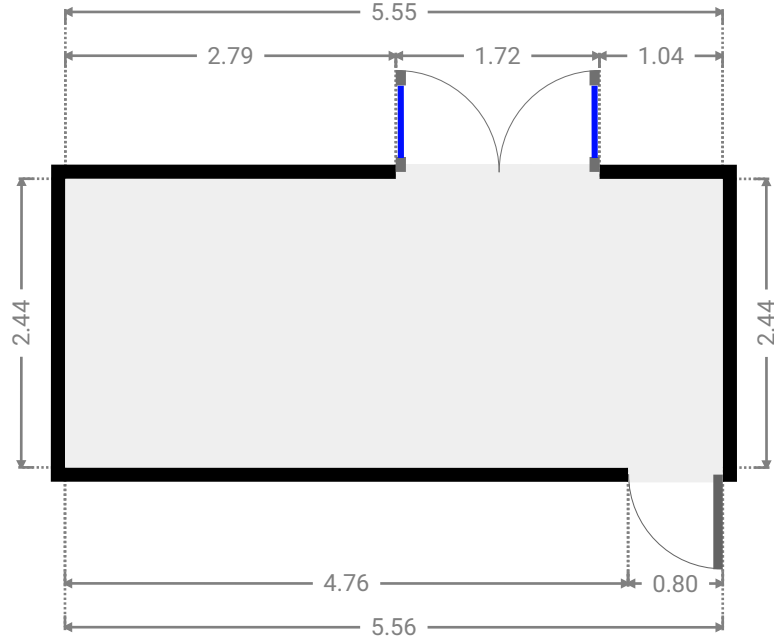

▼ Other
1st Floor

WIDTH: 6.84 m • LENGTH: 3.71 m
AREA: 25.31 m² • PERIMETER: 21.08 m

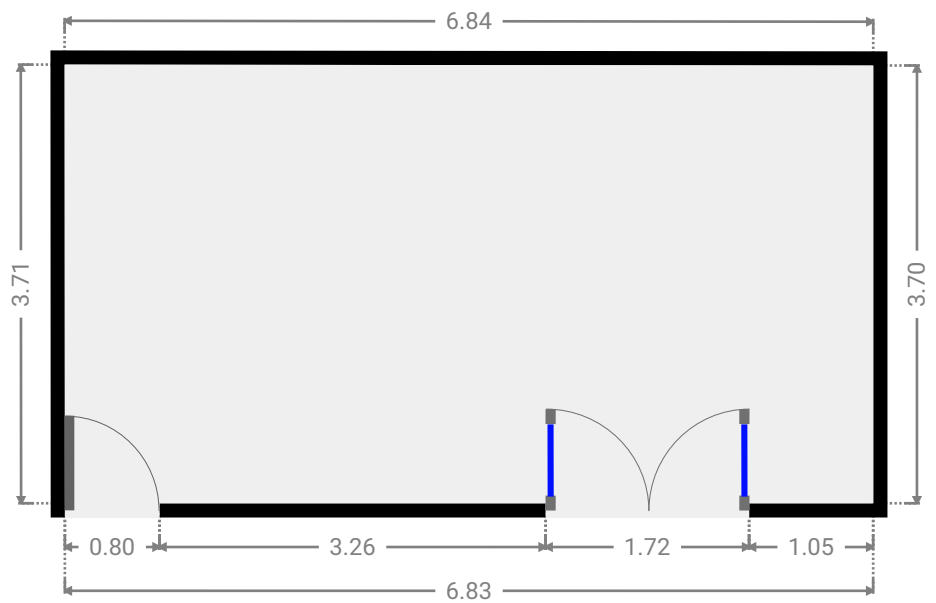

▼ Other
1st Floor

WIDTH: 7.50 m • LENGTH: 6.00 m
AREA: 45.00 m² • PERIMETER: 27.00 m

