

27 Maree Crescent

Ground Floor

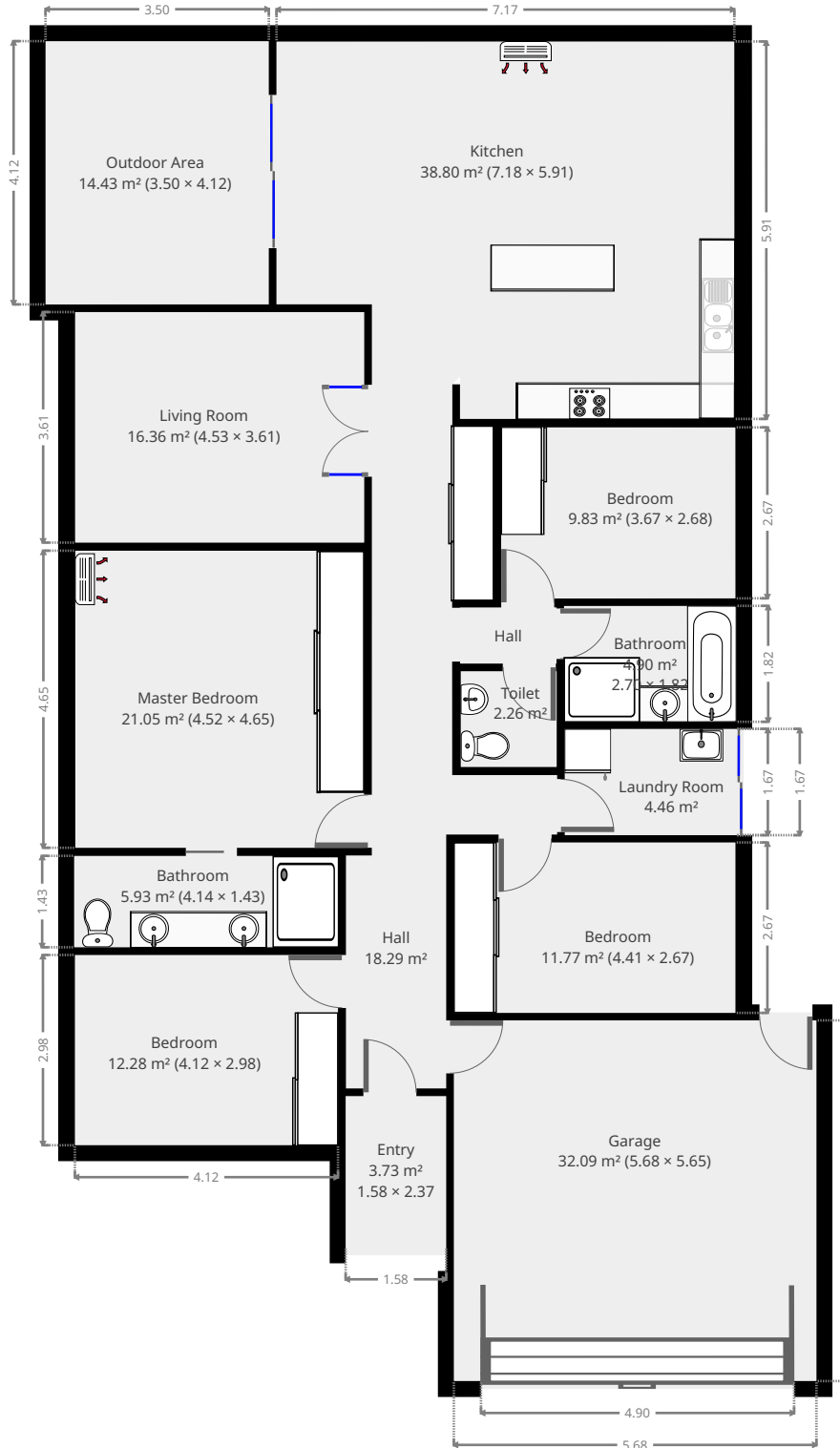

THIS FLOORPLAN IS PROVIDED WITHOUT WARRANTY OF ANY KIND. SENSOPIA DISCLAIMS ANY WARRANTY INCLUDING, WITHOUT LIMITATION, SATISFACTORY QUALITY OR ACCURACY OF DIMENSIONS.



27 Maree Crescent

Hall

Width: 3.31 m
Length: 11.03 m
Area: 18.29 m²
Perimeter: 29.97 m

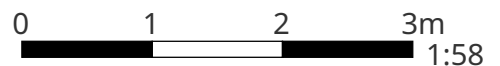
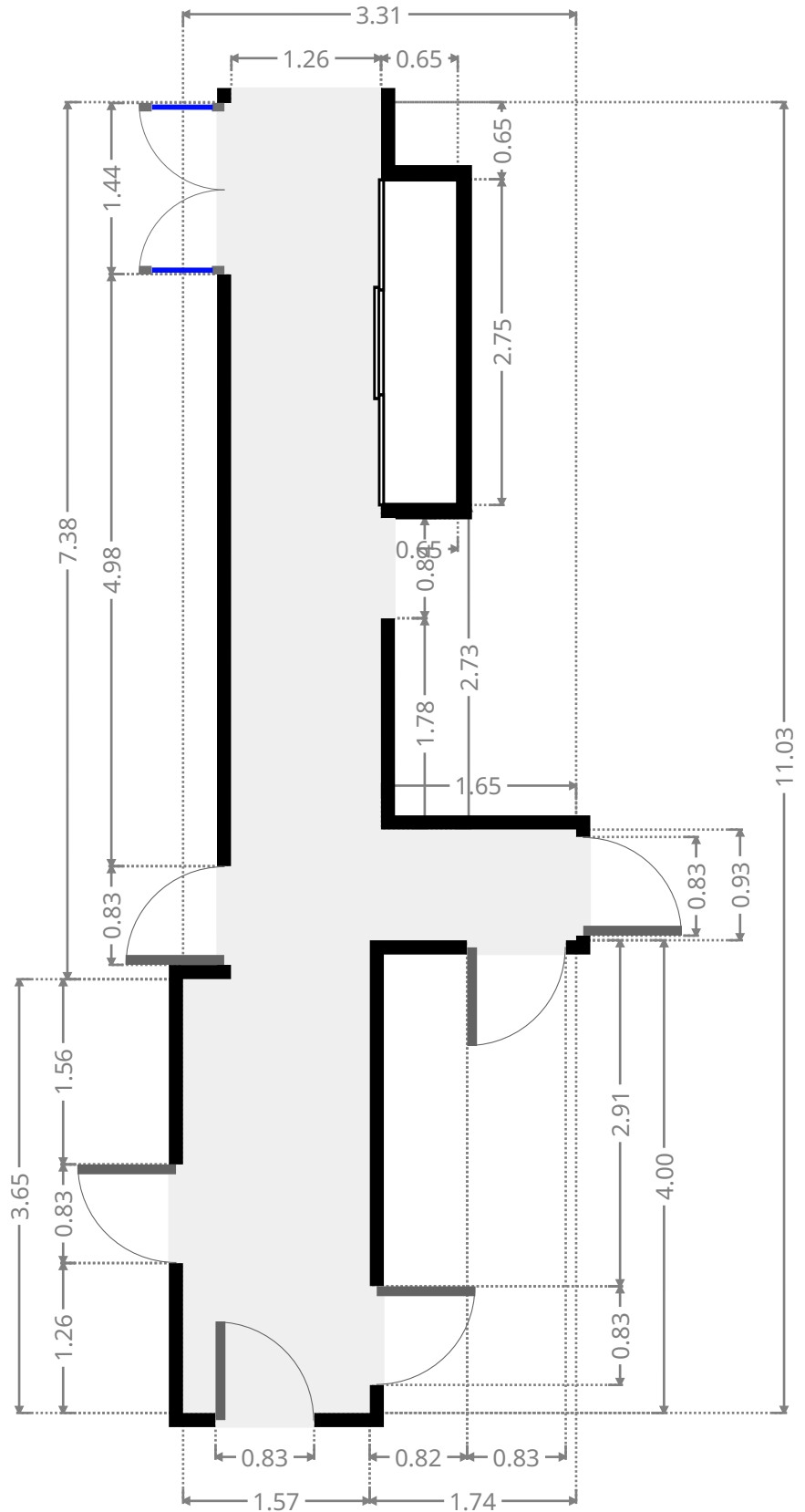
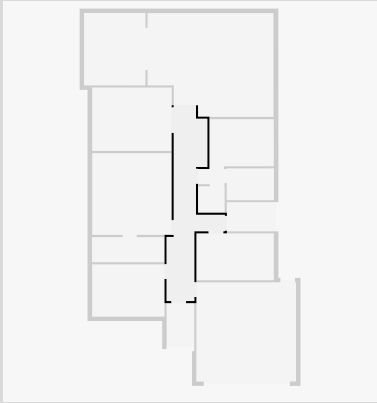

THIS FLOORPLAN IS PROVIDED WITHOUT WARRANTY OF ANY KIND. SENSOPIA DISCLAIMS ANY WARRANTY INCLUDING, WITHOUT LIMITATION, SATISFACTORY QUALITY OR ACCURACY OF DIMENSIONS.

27 Maree Crescent

Bedroom

Width: 2.98 m
Length: 4.12 m
Area: 12.28 m²
Perimeter: 14.20 m

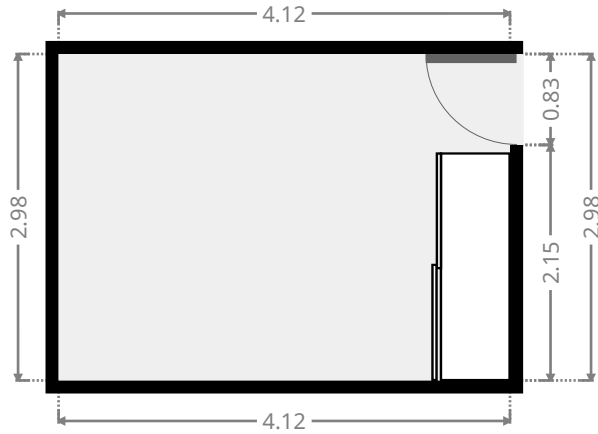
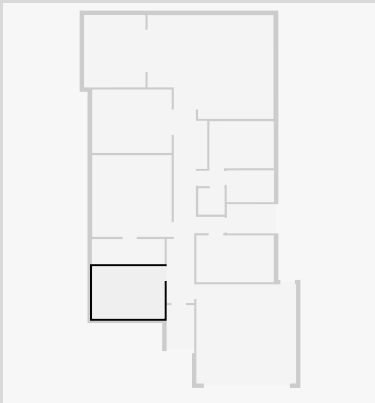

Garage

Width: 5.65 m
Length: 5.68 m
Area: 32.09 m²
Perimeter: 22.66 m

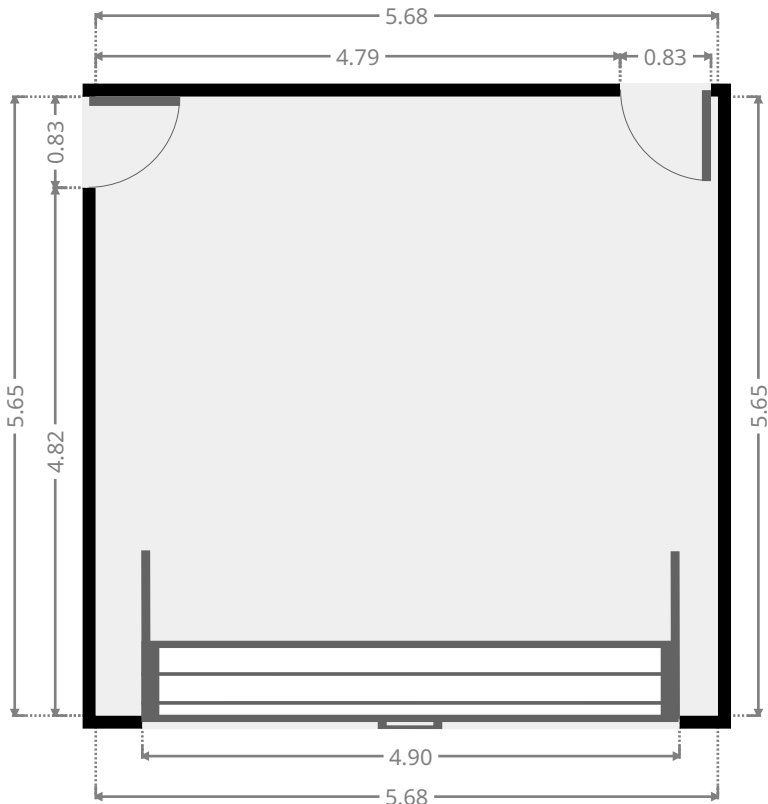
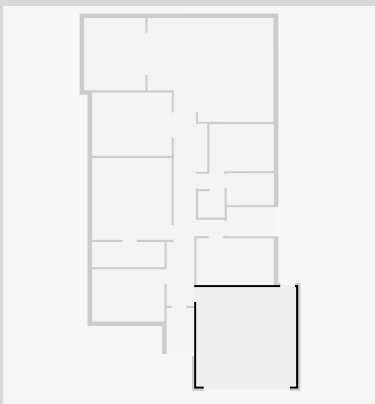

THIS FLOORPLAN IS PROVIDED WITHOUT WARRANTY OF ANY KIND. SENSOPIA DISCLAIMS ANY WARRANTY INCLUDING, WITHOUT LIMITATION, SATISFACTORY QUALITY OR ACCURACY OF DIMENSIONS.

27 Maree Crescent

Master Bedroom

Width: 4.52 m
Length: 4.65 m
Area: 21.05 m²
Perimeter: 18.35 m

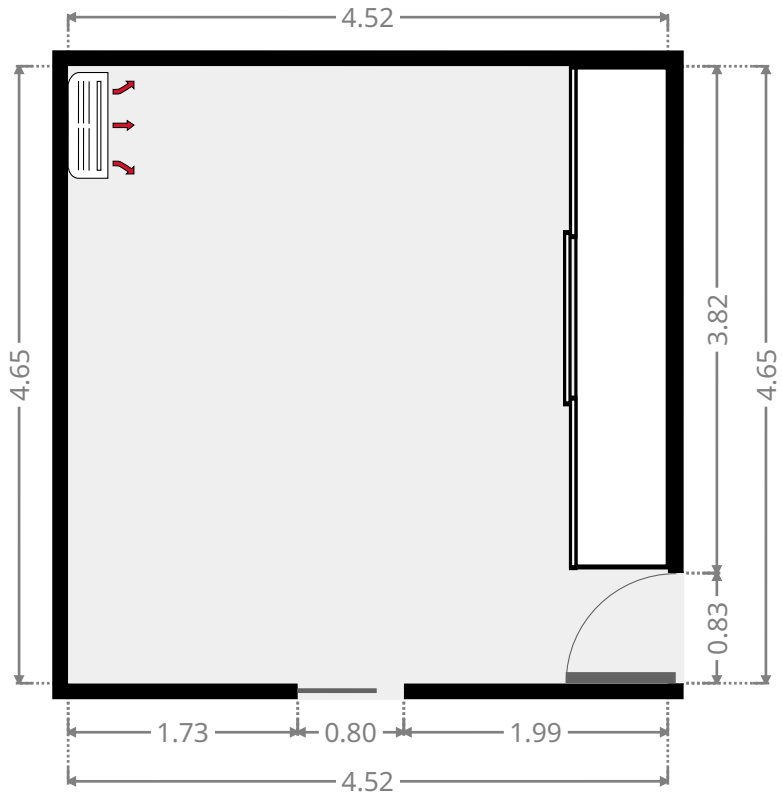
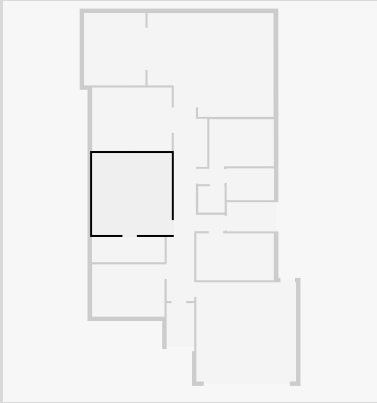

Bathroom

Width: 1.43 m
Length: 4.14 m
Area: 5.93 m²
Perimeter: 11.15 m

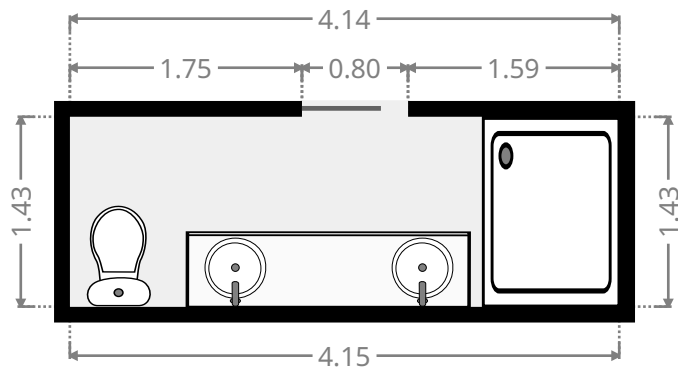
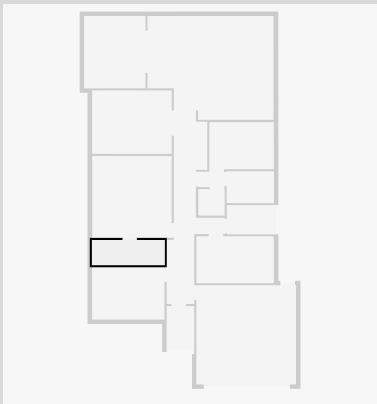

27 Maree Crescent

Bedroom

Width: 2.67 m
 Length: 4.41 m
 Area: 11.77 m²
 Perimeter: 14.16 m

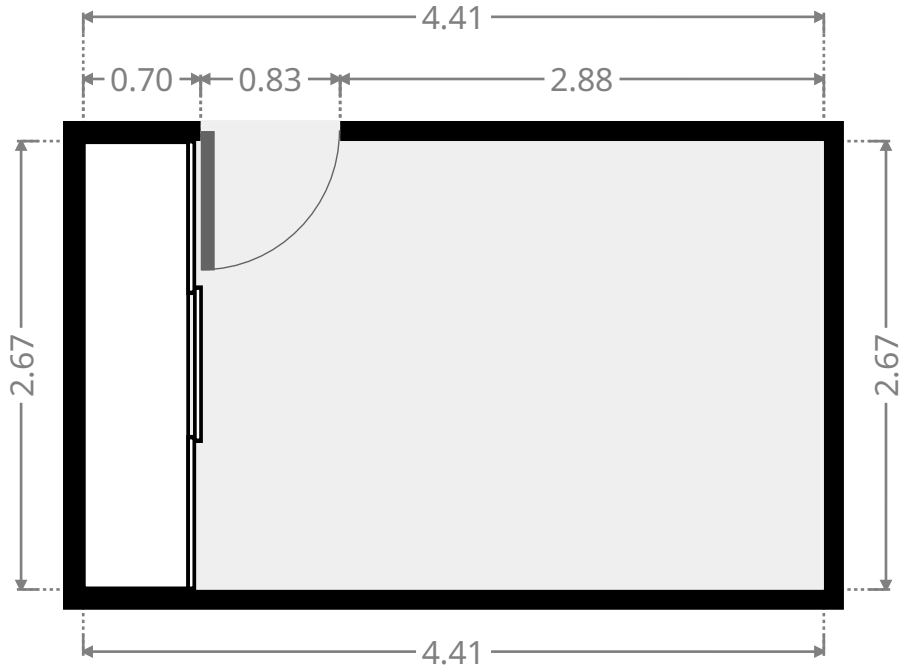
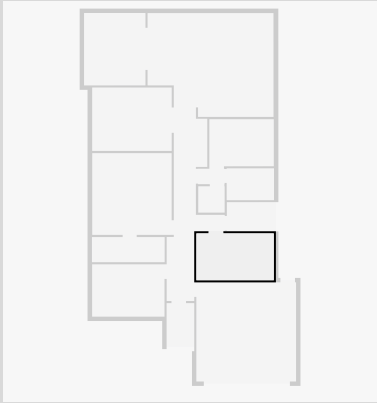

Laundry Room

Width: 1.67 m
 Length: 2.68 m
 Area: 4.46 m²
 Perimeter: 8.69 m

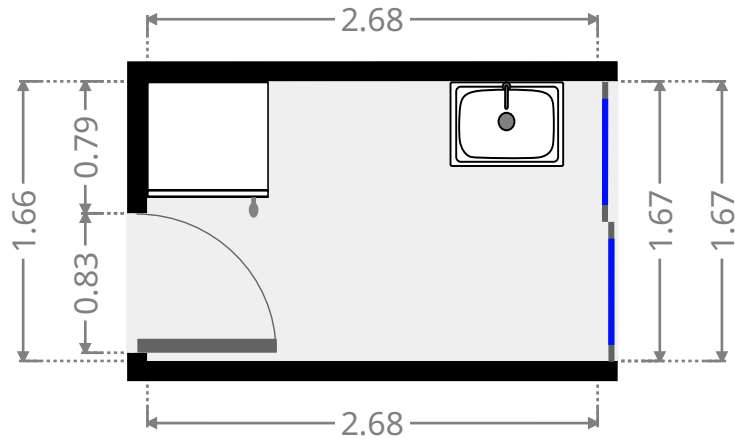
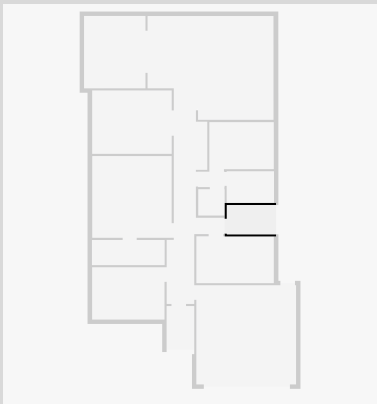

27 Maree Crescent

Toilet / Half Bath

Width: 1.50 m
Length: 1.50 m
Area: 2.26 m²
Perimeter: 6.01 m

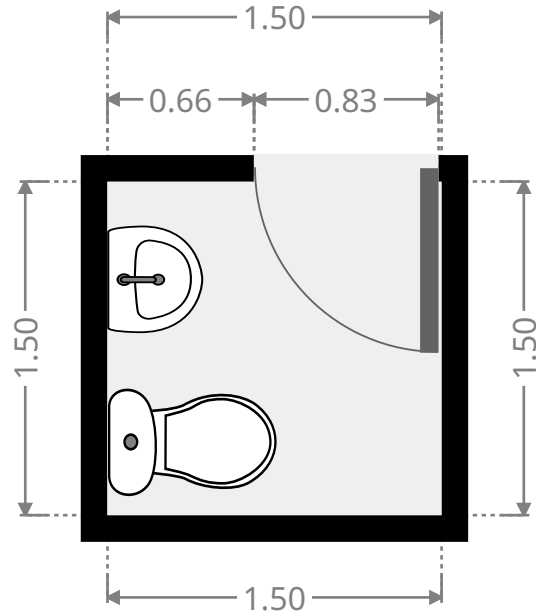
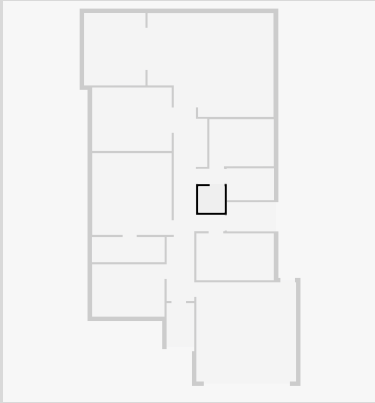

Bathroom

Width: 1.82 m
Length: 2.70 m
Area: 4.90 m²
Perimeter: 9.02 m

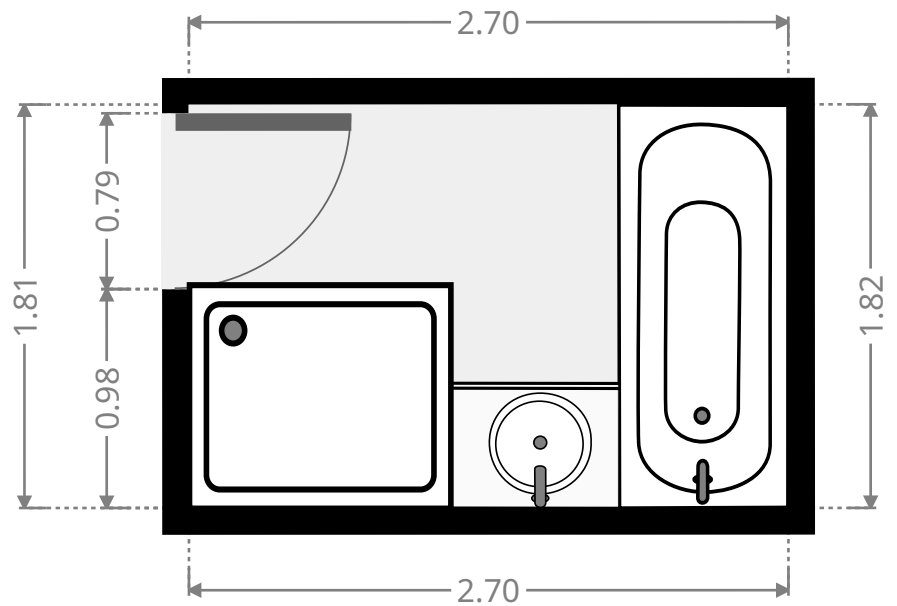
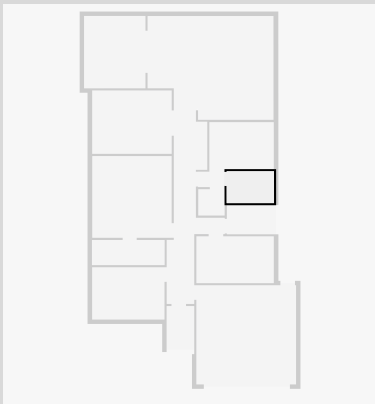

27 Maree Crescent

Hall

Width: 0.88 m
 Length: 1.51 m
 Area: 1.33 m²
 Perimeter: 4.78 m

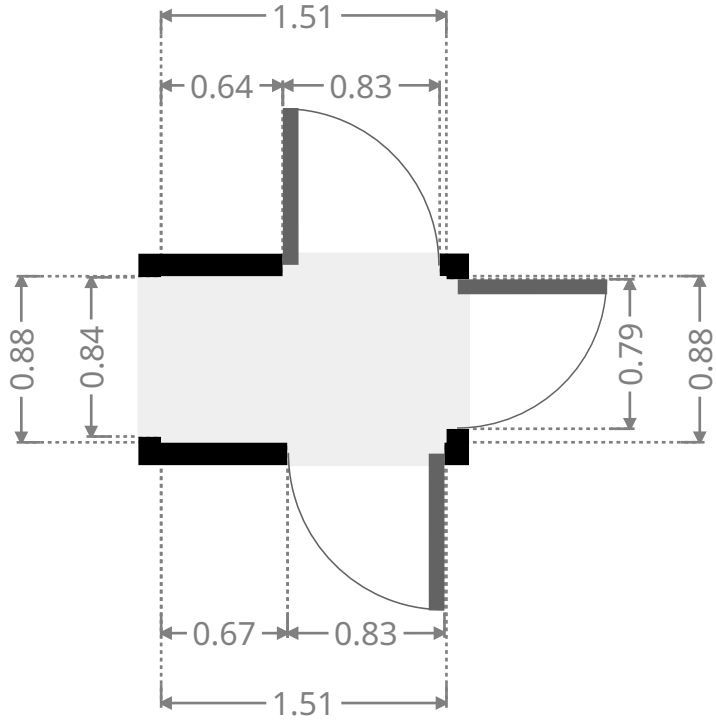
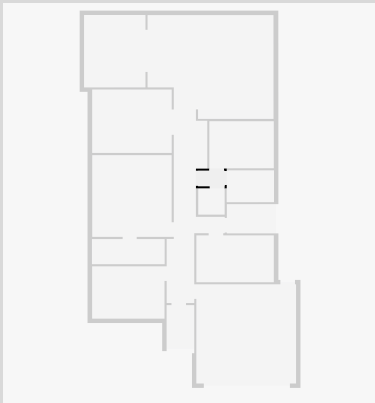

Bedroom

Width: 2.68 m
 Length: 3.67 m
 Area: 9.83 m²
 Perimeter: 12.70 m

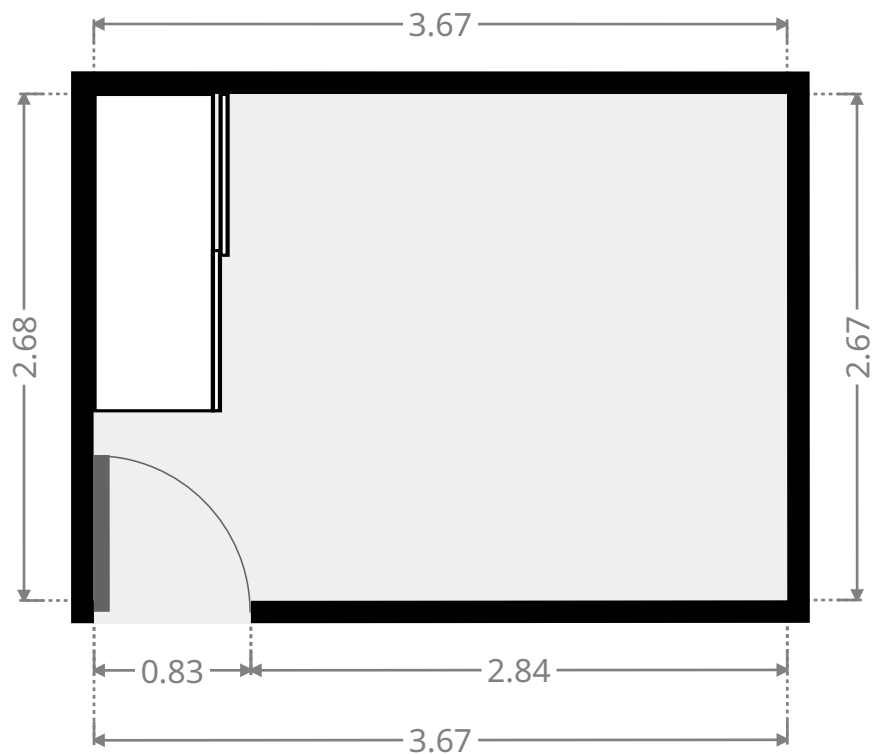
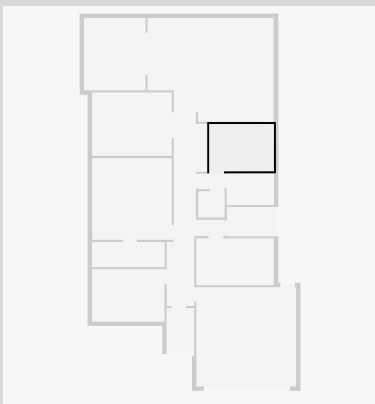

27 Maree Crescent

Living Room

Width: 3.61 m
 Length: 4.53 m
 Area: 16.36 m²
 Perimeter: 16.28 m

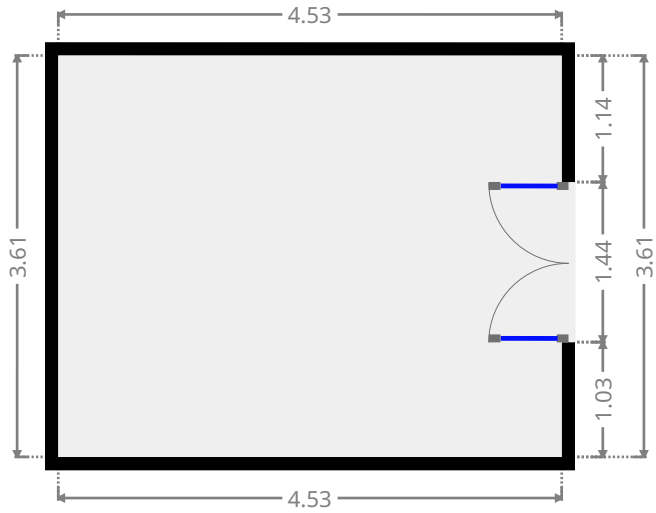
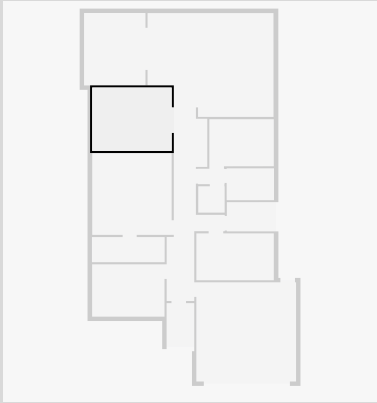

Kitchen

Width: 5.91 m
 Length: 7.18 m
 Area: 38.80 m²
 Perimeter: 26.17 m

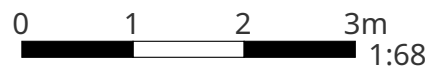
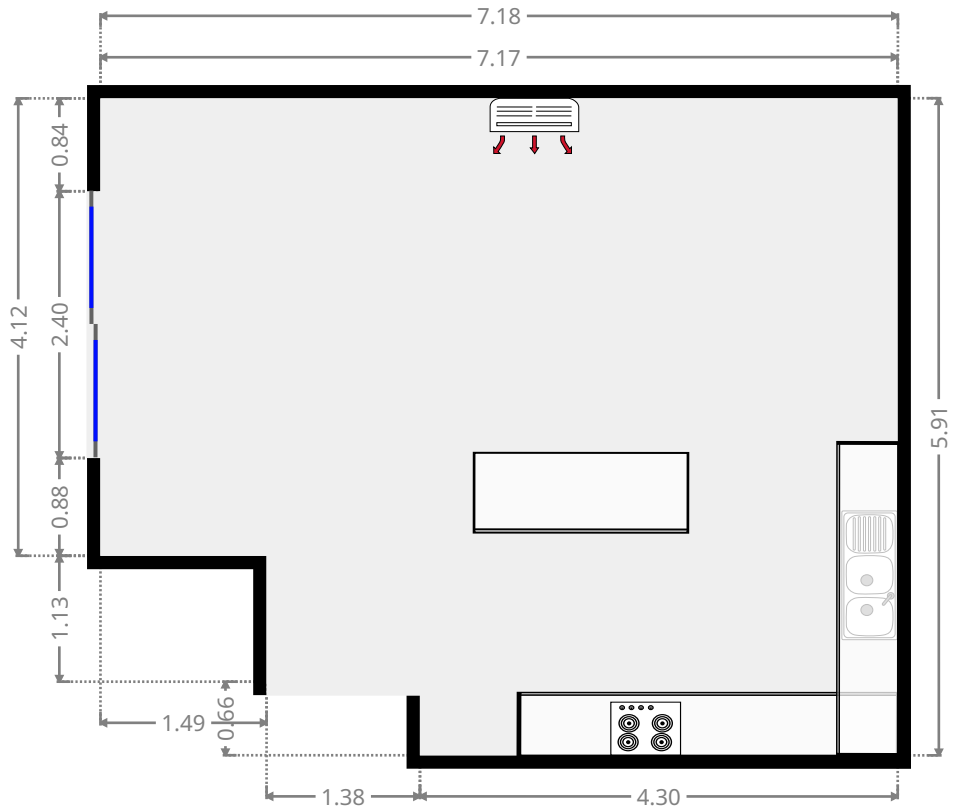
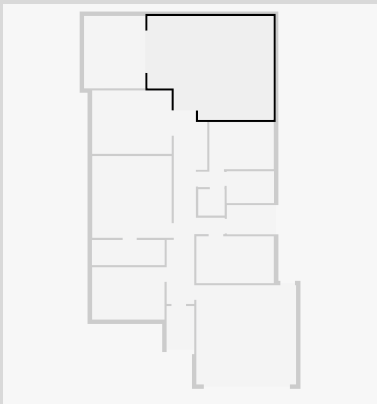

THIS FLOORPLAN IS PROVIDED WITHOUT WARRANTY OF ANY KIND. SENSOPIA DISCLAIMS ANY WARRANTY INCLUDING, WITHOUT LIMITATION, SATISFACTORY QUALITY OR ACCURACY OF DIMENSIONS.

27 Maree Crescent

Outdoor Area

Width: 3.50 m
 Length: 4.12 m
 Area: 14.43 m²
 Perimeter: 15.24 m

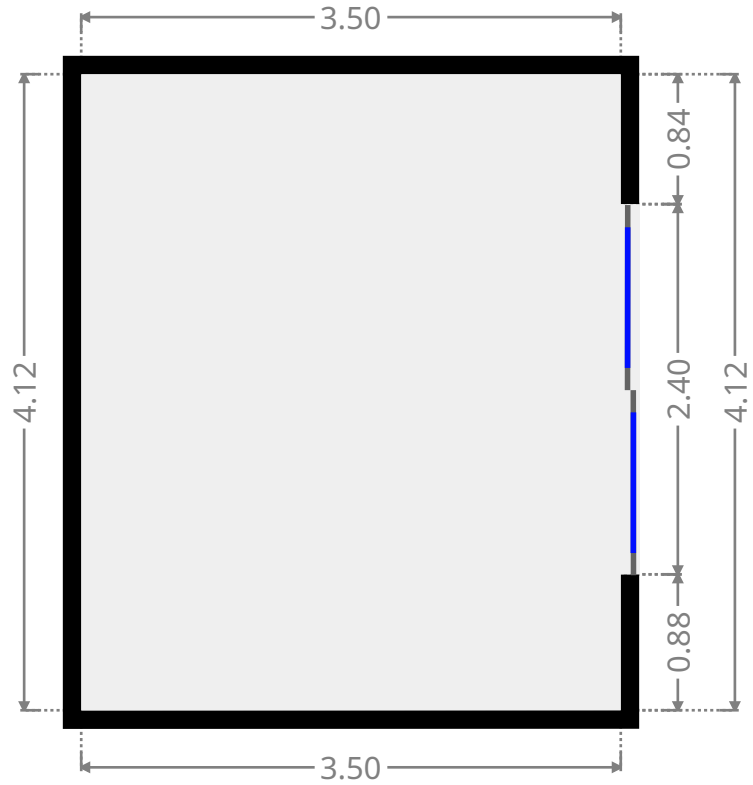
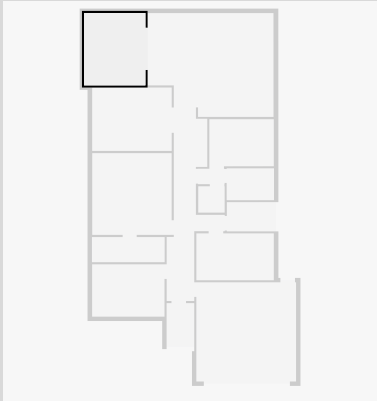

Entry

Width: 1.58 m
 Length: 2.37 m
 Area: 3.73 m²
 Perimeter: 7.89 m

