

27 Hogan Street

Created on
2020-12-08

Floors
2

▼ Ground Floor

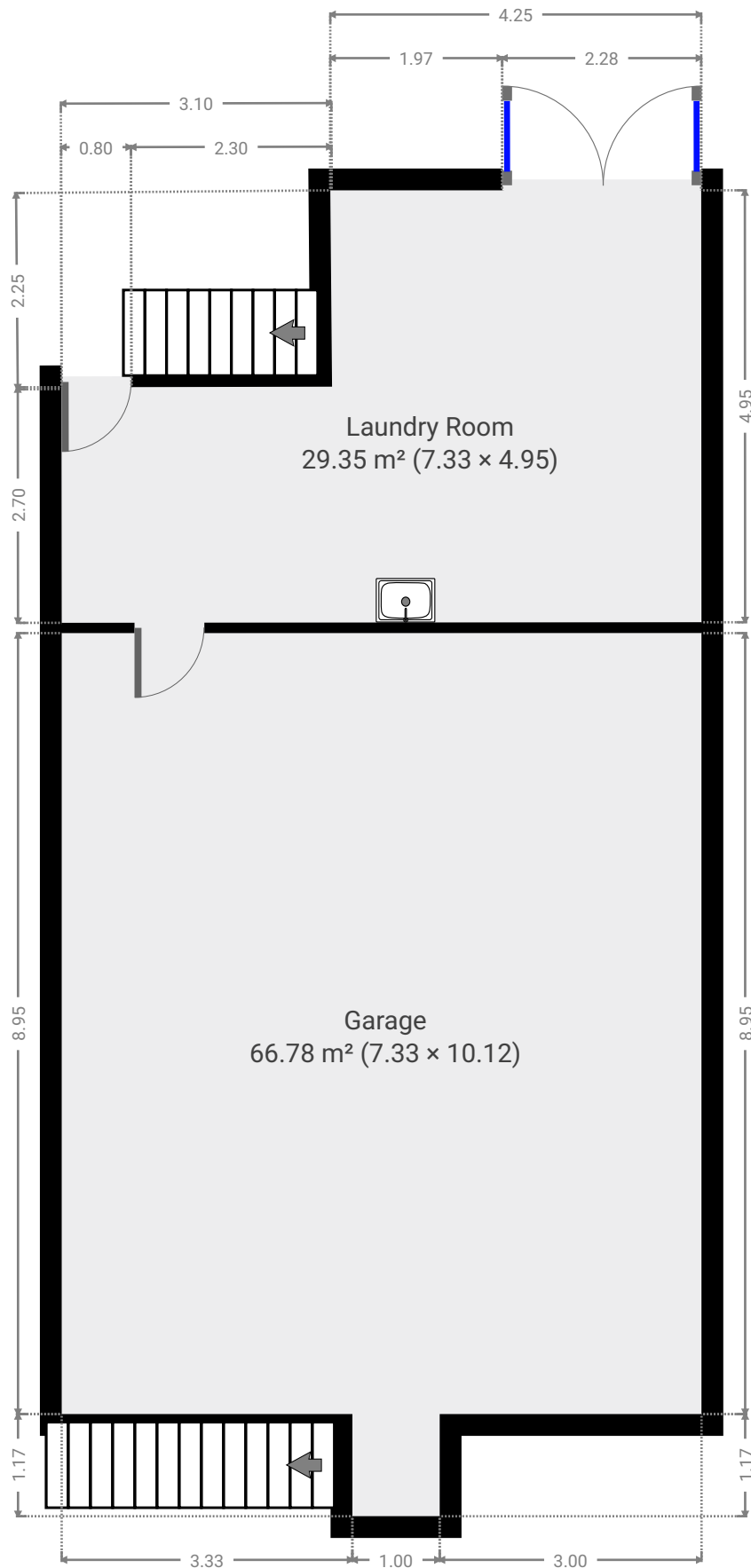

▼ Laundry Room
Ground Floor

WIDTH:7.33 m · LENGTH:4.95 m
AREA:29.35 m² · PERIMETER:24.58 m

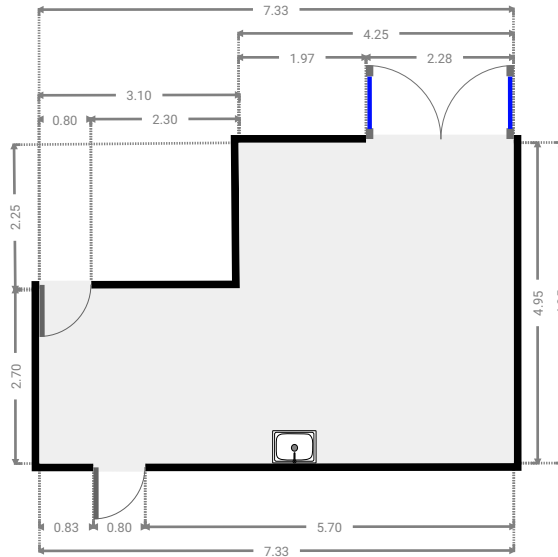
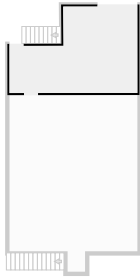

▼ Garage
Ground Floor

WIDTH:7.33 m · LENGTH:10.12 m
AREA:66.78 m² · PERIMETER:34.90 m

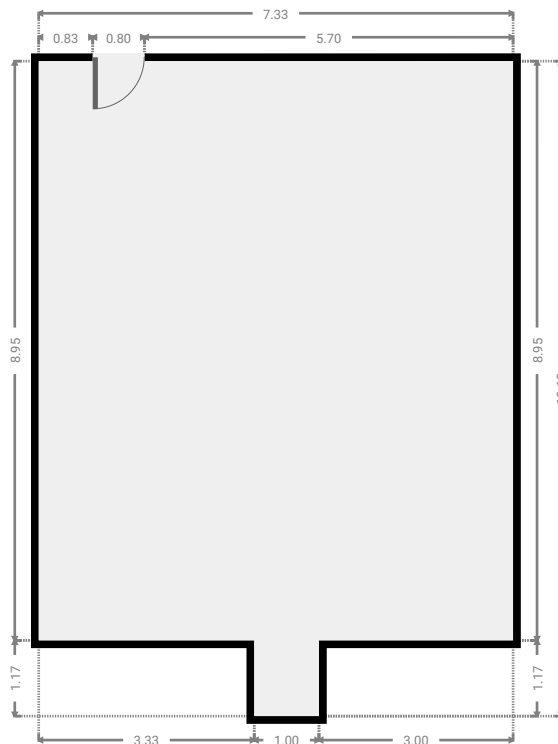
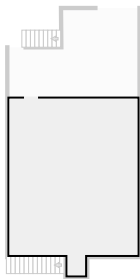

▼ 1st Floor

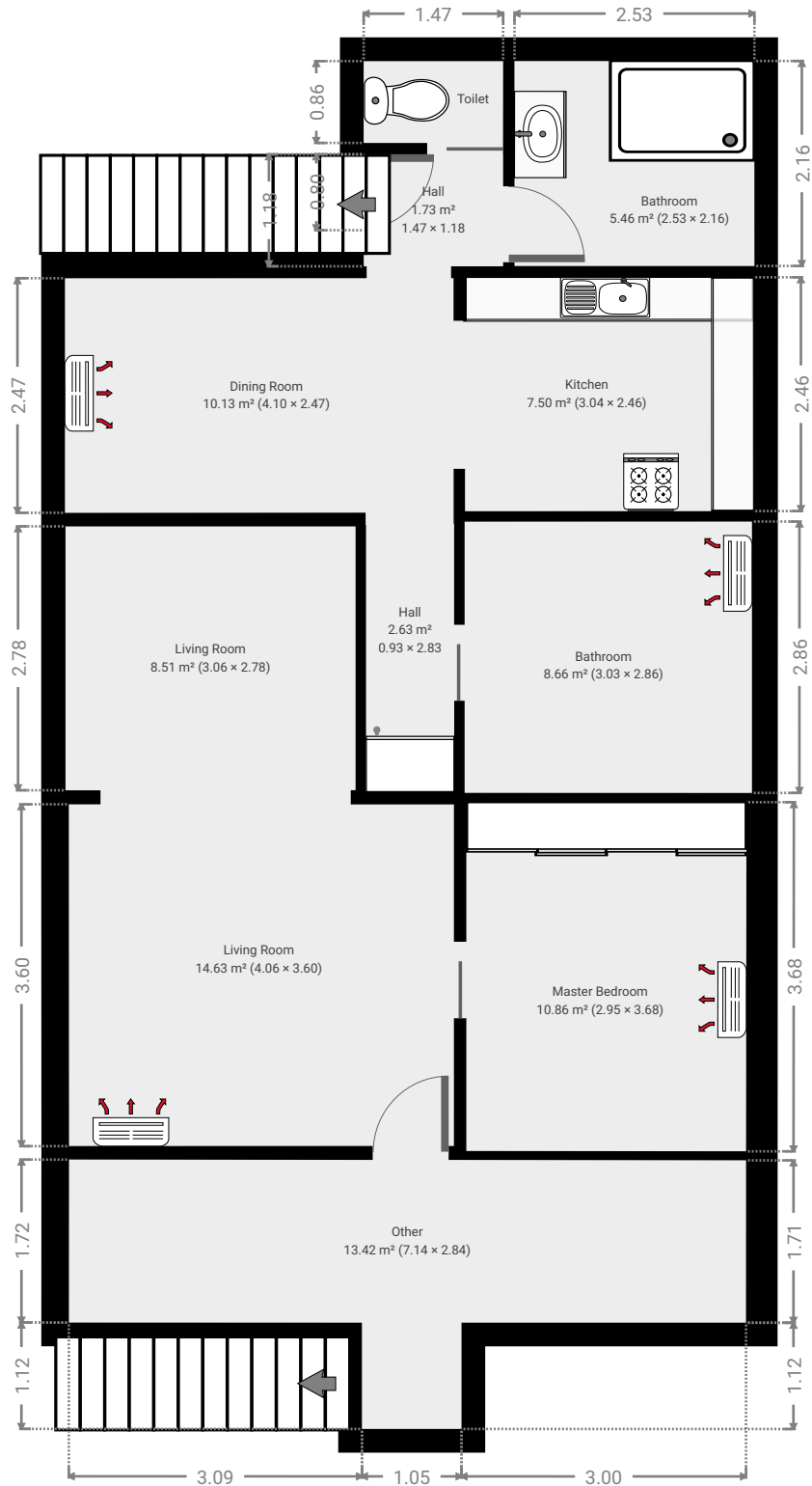

▼ **Living Room**
1st Floor

WIDTH:4.06 m · LENGTH:3.60 m
AREA:14.63 m² · PERIMETER:15.32 m

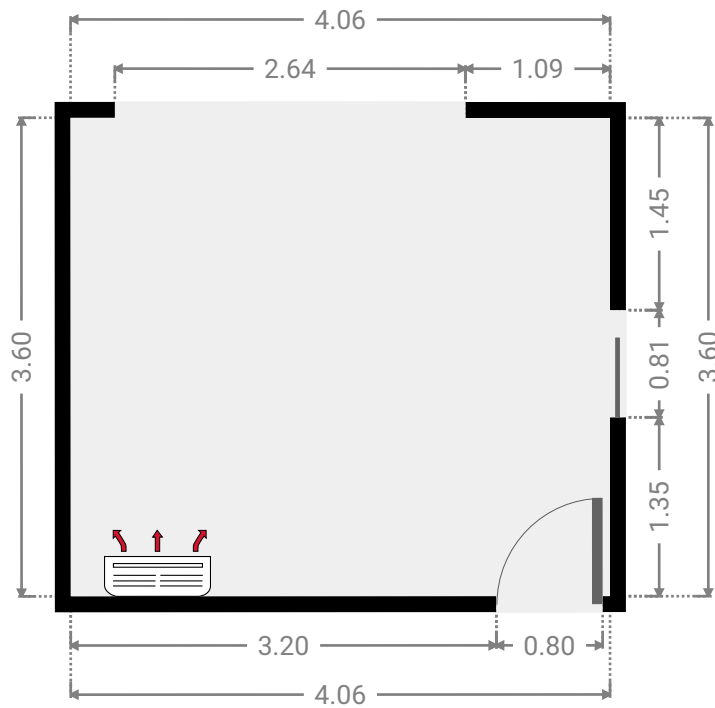
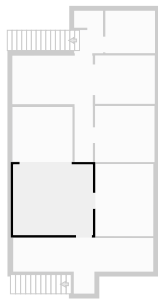

▼ **Living Room**
1st Floor

WIDTH:3.06 m · LENGTH:2.78 m
AREA:8.51 m² · PERIMETER:11.68 m

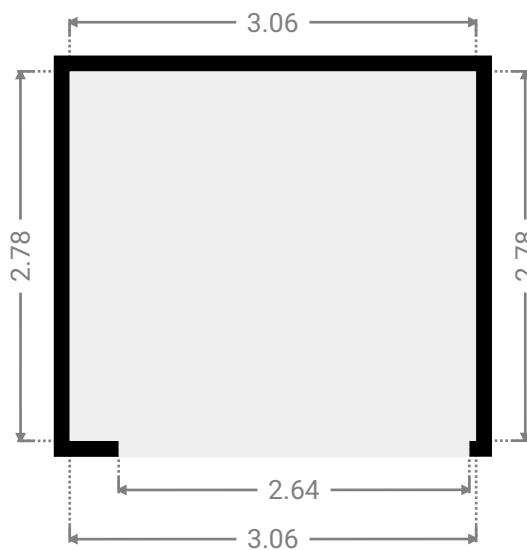
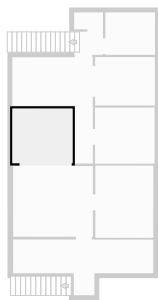

▼ **Master Bedroom**
1st Floor

WIDTH:2.95 m · LENGTH:3.68 m
AREA:10.86 m² · PERIMETER:13.26 m

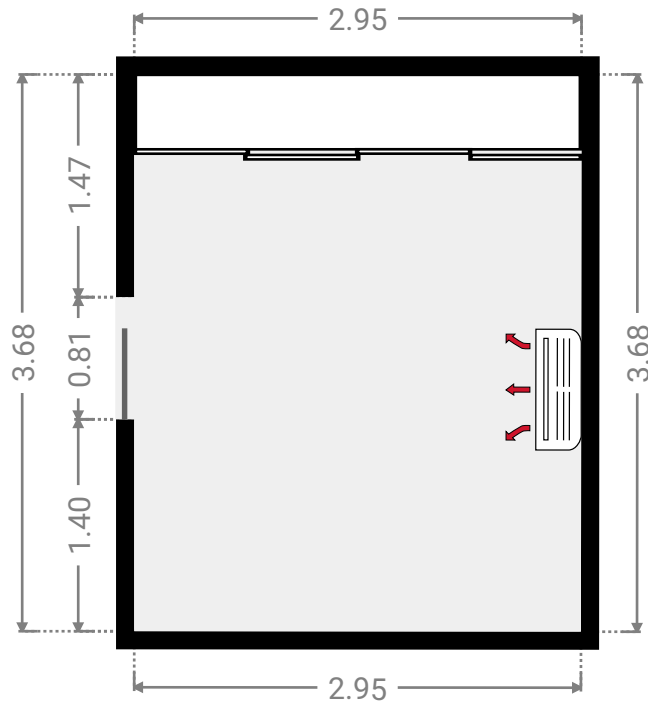
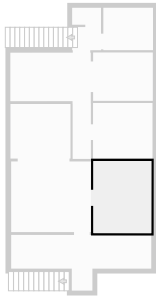

▼ **Hall**
1st Floor

WIDTH:0.93 m · LENGTH:2.83 m
AREA:2.63 m² · PERIMETER:7.51 m

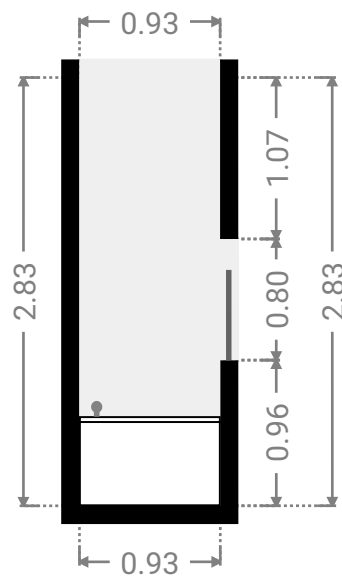
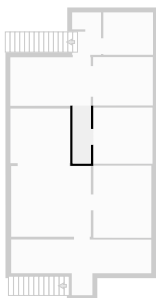

▼ Bathroom
1st Floor

WIDTH:3.03 m · LENGTH:2.86 m
AREA:8.66 m² · PERIMETER:11.78 m

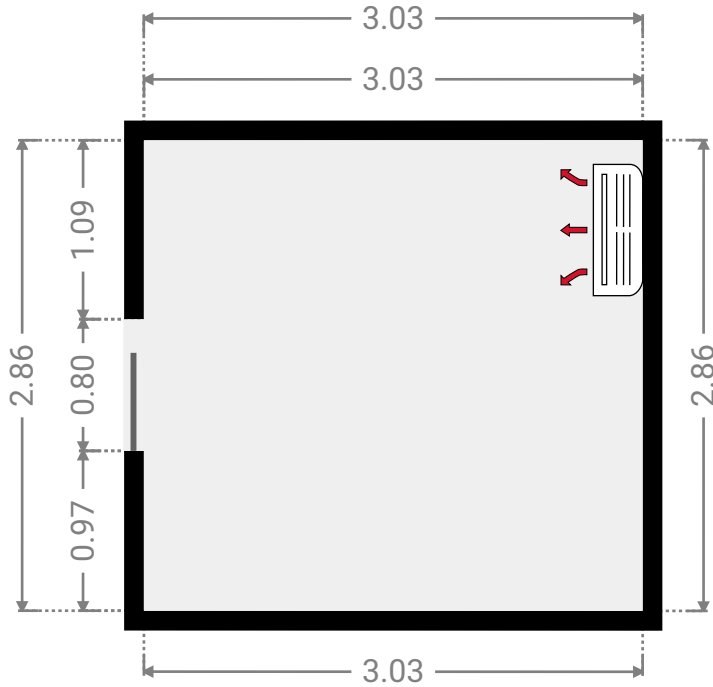
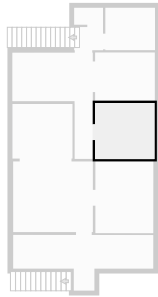

▼ Dining Room
1st Floor

WIDTH:4.10 m · LENGTH:2.47 m
AREA:10.13 m² · PERIMETER:13.14 m

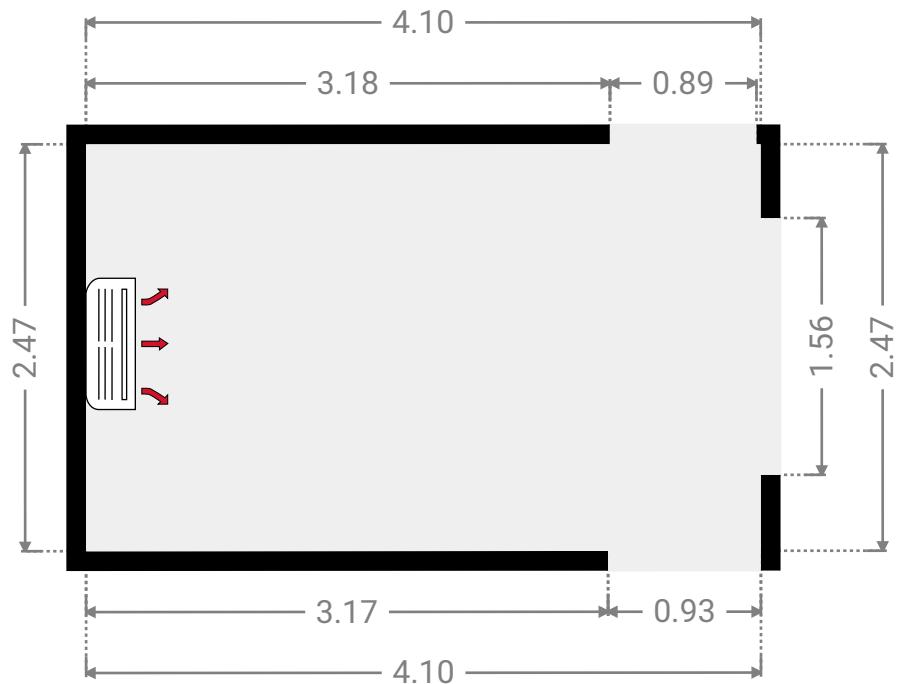
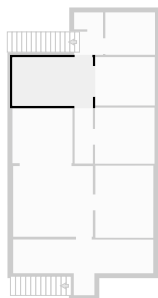

▼ **Kitchen**
1st Floor

WIDTH:3.04 m · LENGTH:2.46 m
AREA:7.50 m² · PERIMETER:11.01 m

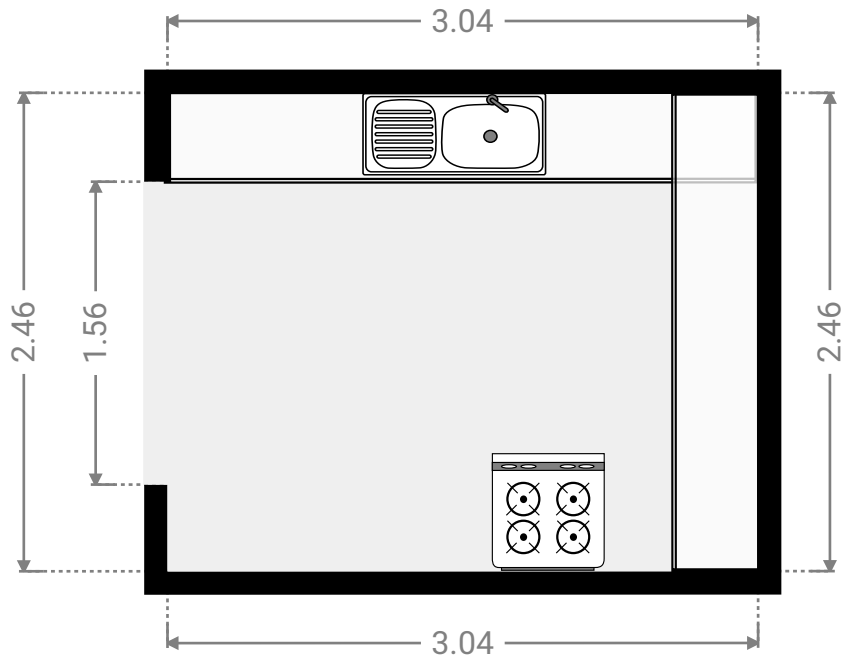
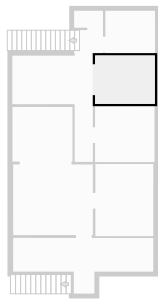

▼ **Hall**
1st Floor

WIDTH:1.47 m · LENGTH:1.18 m
AREA:1.73 m² · PERIMETER:5.30 m

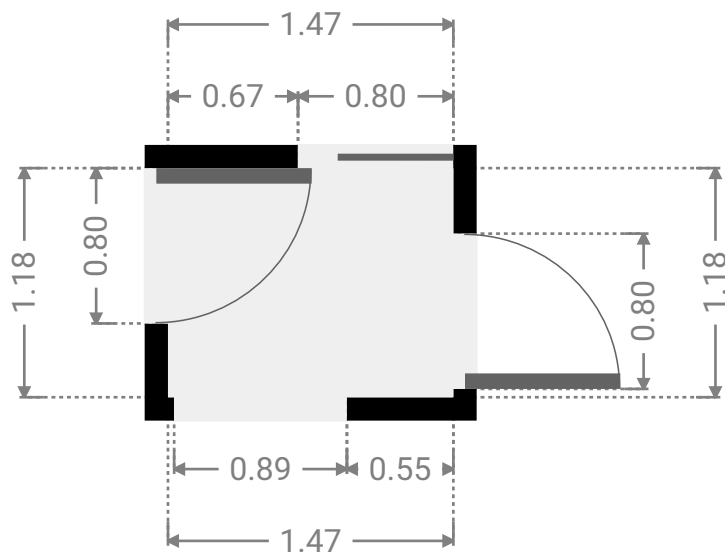
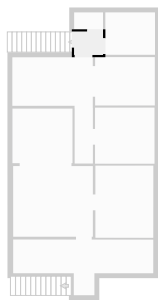

▼ **Bathroom**
1st Floor

WIDTH:2.53 m · LENGTH:2.16 m
AREA:5.46 m² · PERIMETER:9.38 m

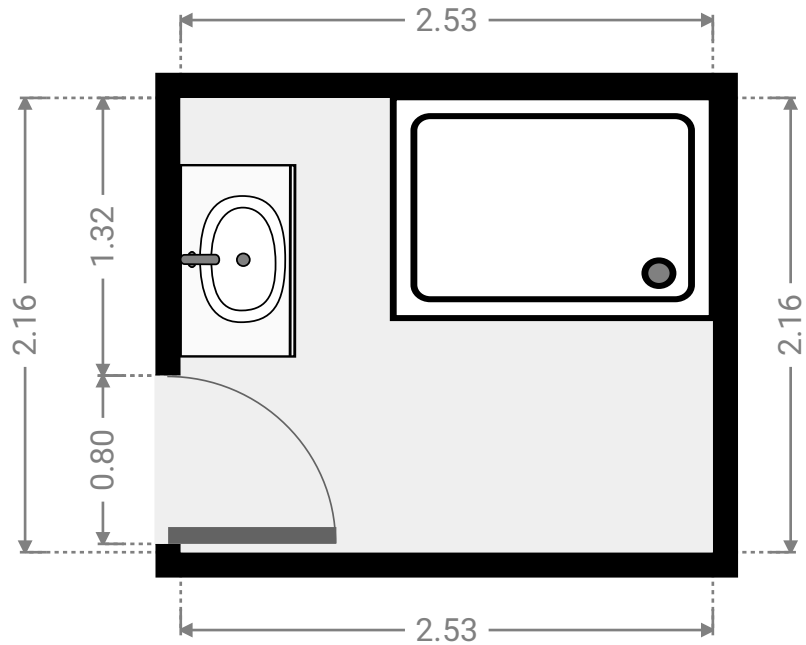
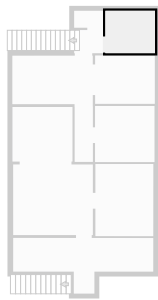

▼ **Toilet**
1st Floor

WIDTH:1.47 m · LENGTH:0.86 m
AREA:1.27 m² · PERIMETER:4.66 m

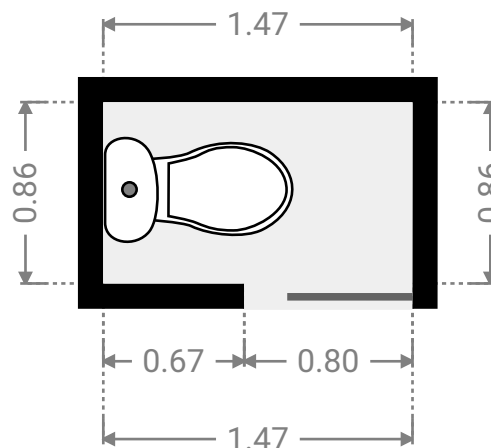
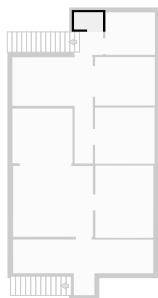

▼ Other
1st Floor

WIDTH:7.14 m · LENGTH:2.84 m
AREA:13.42 m² · PERIMETER:19.95 m

