

262 Hook Street

SUBMITTED BY

Ray White Rockhampton Casey
stockers@cqoz.com

CREATED ON

2021-11-18

Floors

1

▼ Ground Floor

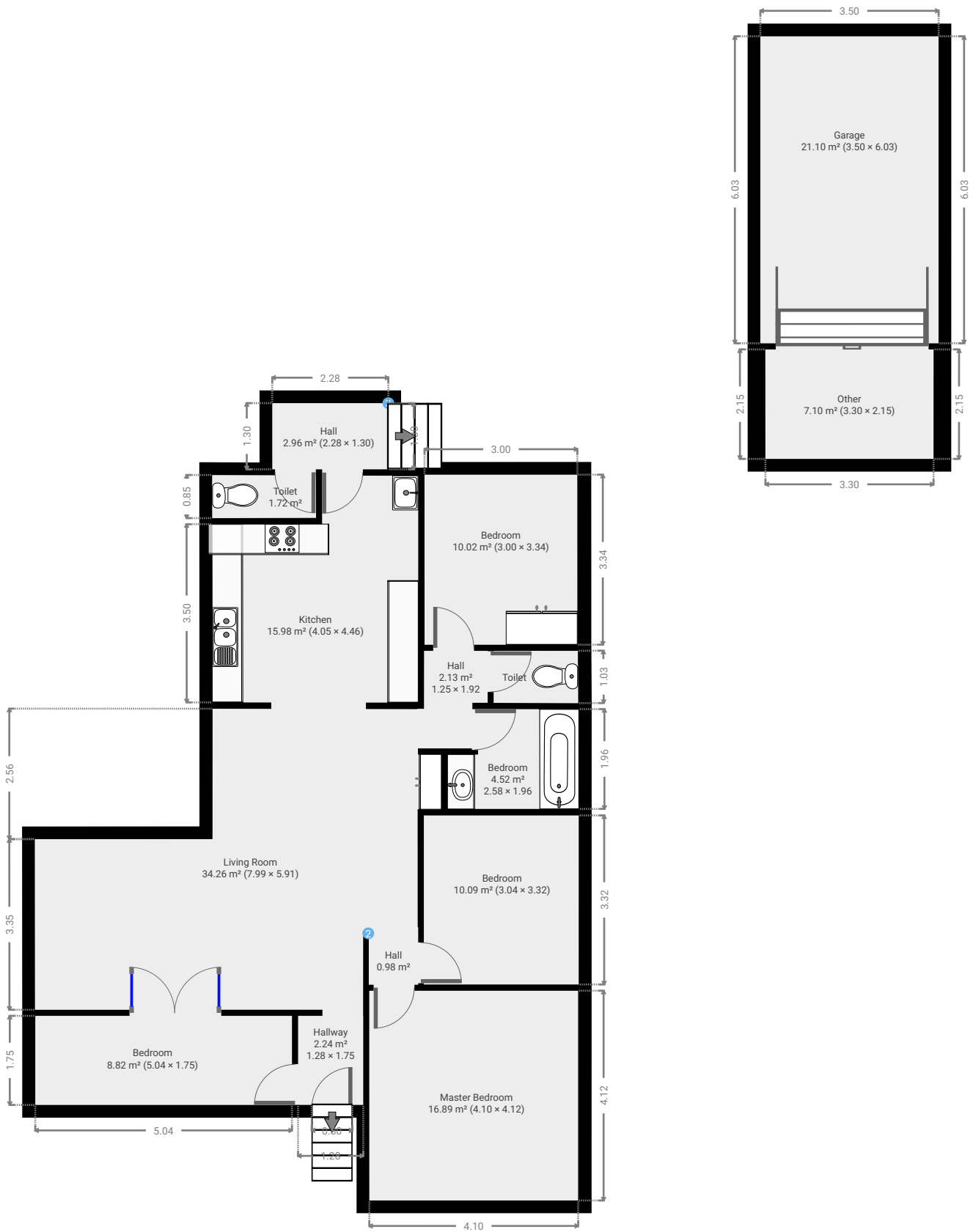

FLOORS: 1

▼ **Hallway**
Ground Floor

WIDTH: 1.28 m • LENGTH: 1.75 m
AREA: 2.24 m² • PERIMETER: 6.06 m

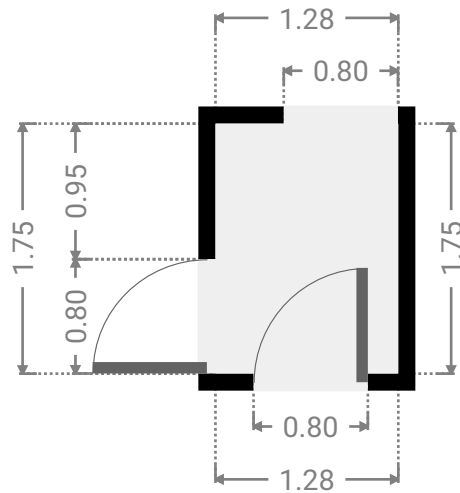
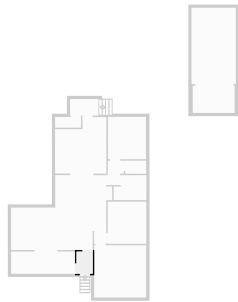

▼ **Bedroom**
Ground Floor

WIDTH: 5.04 m • LENGTH: 1.75 m
AREA: 8.82 m² • PERIMETER: 13.58 m

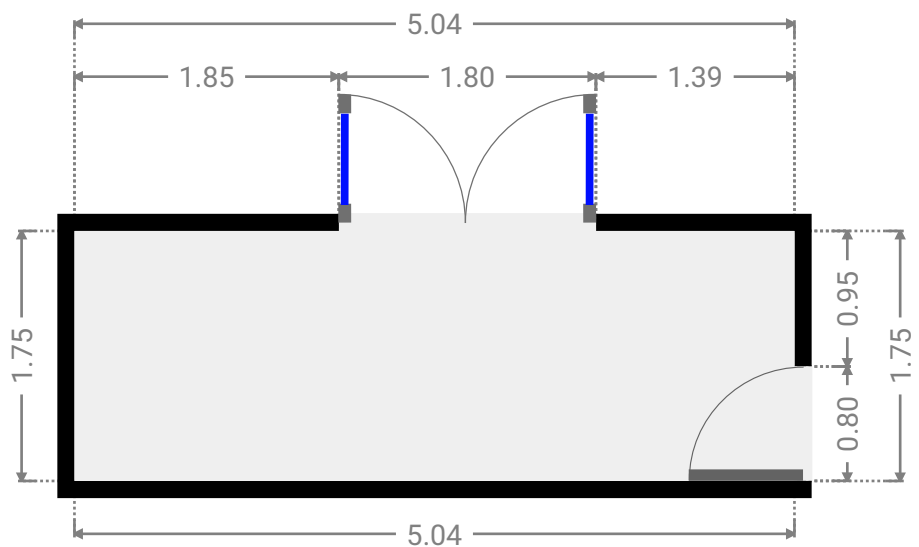

▼ **Living Room**
Ground Floor

WIDTH: 7.99 m • LENGTH: 5.91 m
AREA: 34.26 m² • PERIMETER: 27.78 m

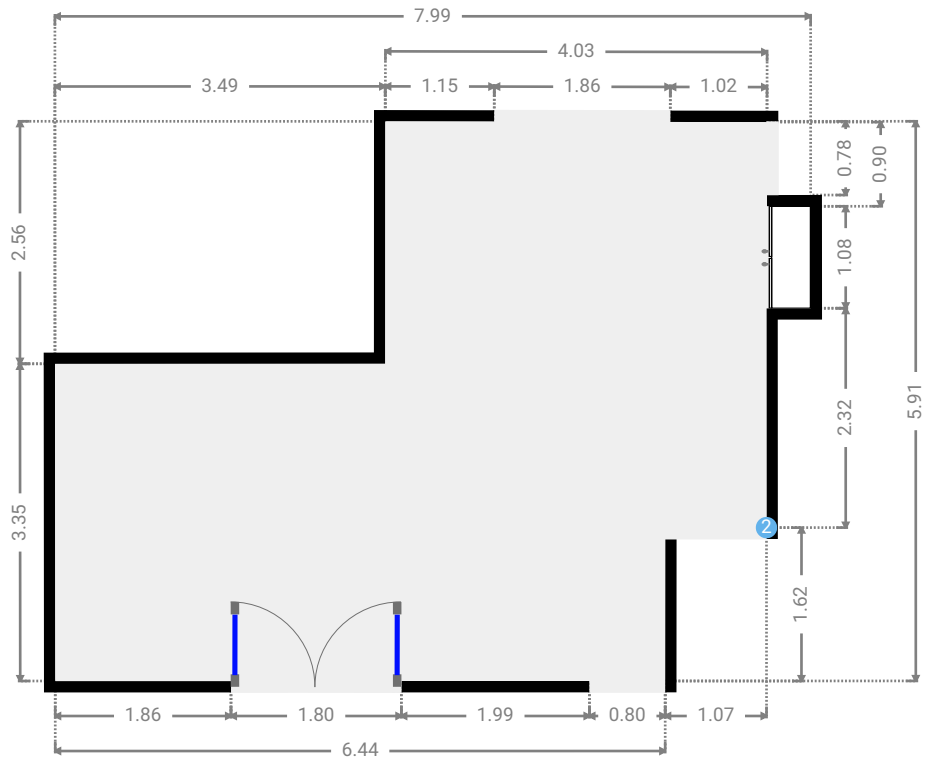

▼ **Master Bedroom**
Ground Floor

WIDTH: 4.10 m • LENGTH: 4.12 m
AREA: 16.89 m² • PERIMETER: 16.44 m

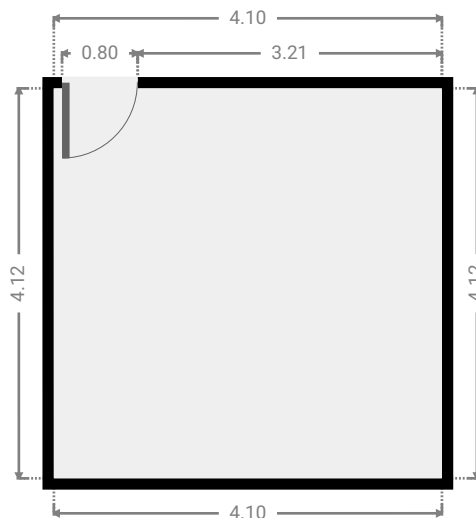
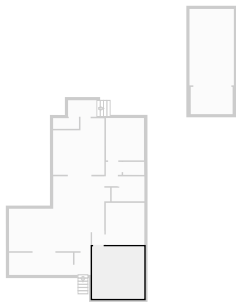

▼ **Hall**
Ground Floor

WIDTH: 0.97 m • LENGTH: 1.01 m
AREA: 0.98 m² • PERIMETER: 3.96 m

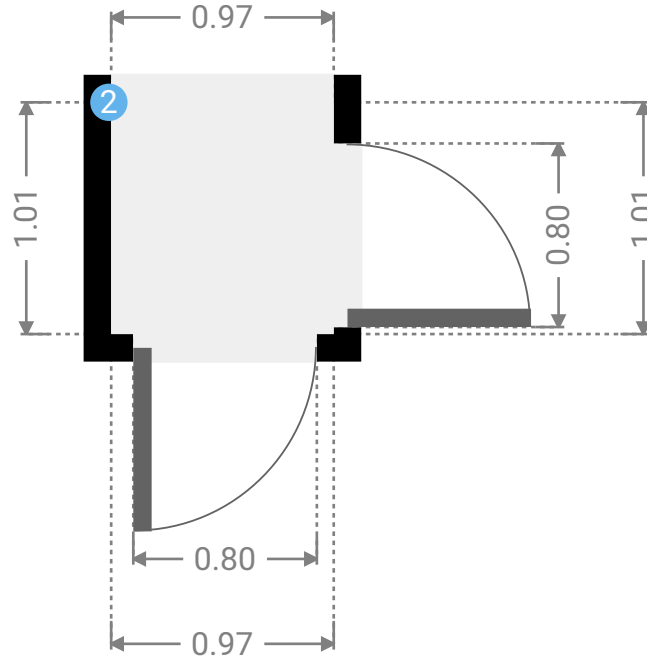

▼ **Hall/Ground Floor**

2 OPENING

Height
0.00 m



▼ **Bedroom**
Ground Floor

WIDTH: 3.04 m • LENGTH: 3.32 m
AREA: 10.09 m² • PERIMETER: 12.72 m

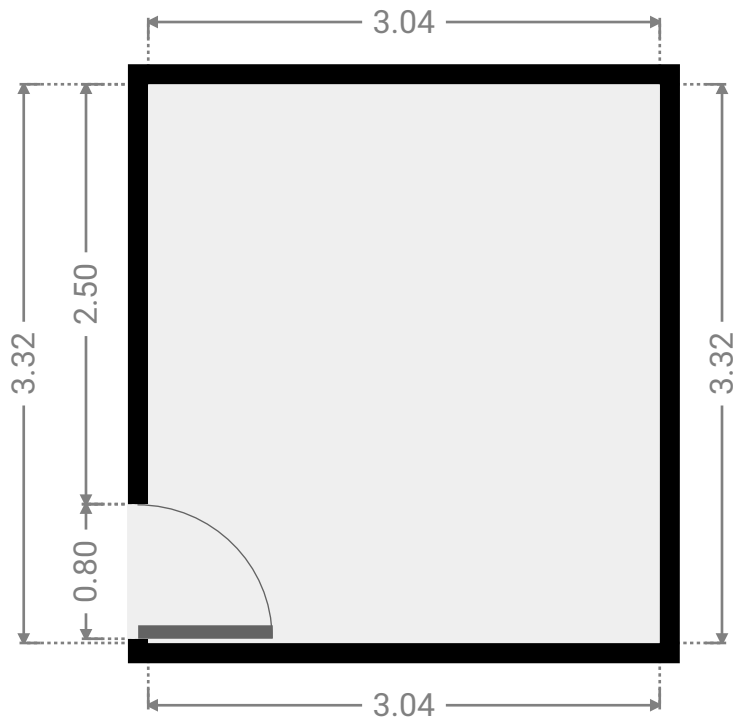
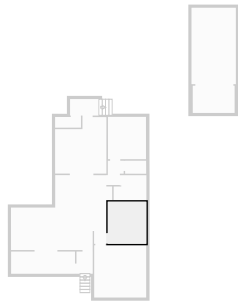

▼ **Hall**
Ground Floor

WIDTH: 1.25 m • LENGTH: 1.92 m
AREA: 2.13 m² • PERIMETER: 6.33 m

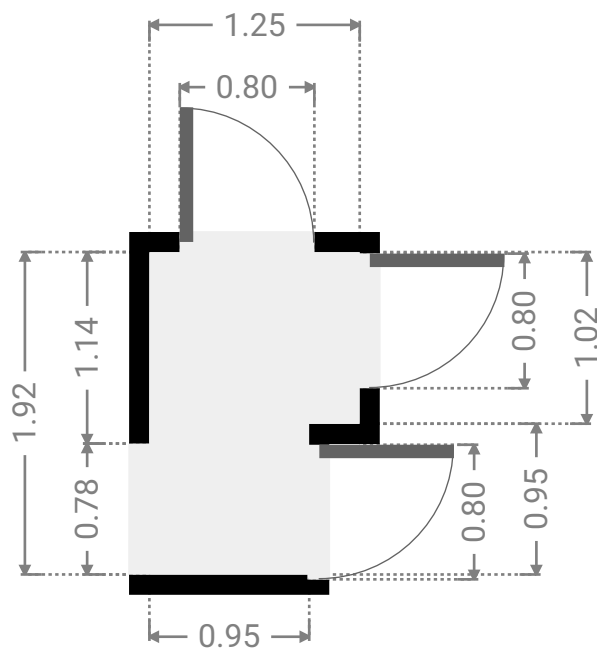
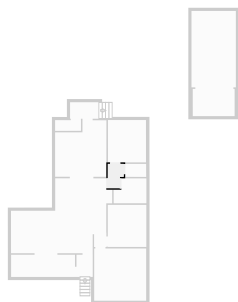

▼ **Bedroom**
Ground Floor

WIDTH: 2.58 m • LENGTH: 1.96 m
AREA: 4.52 m² • PERIMETER: 9.08 m

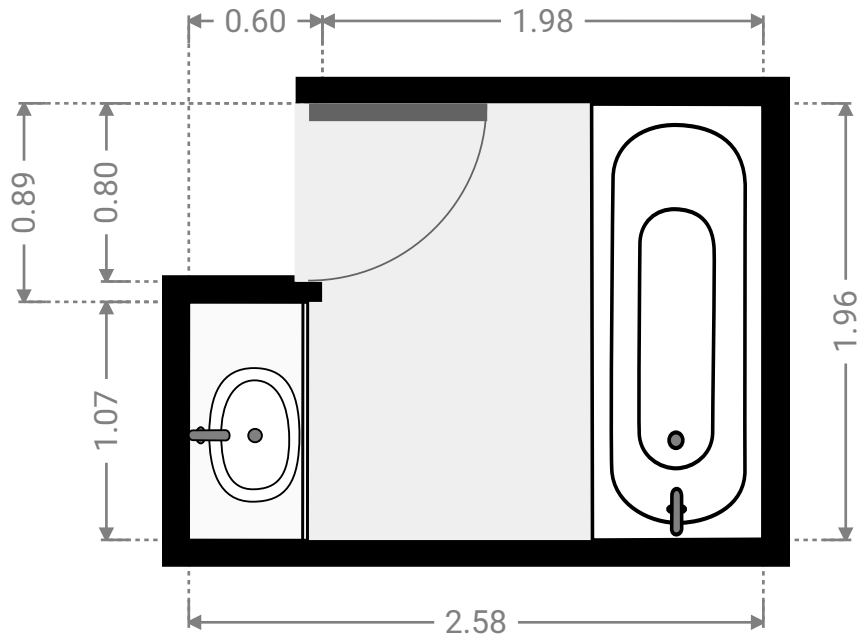
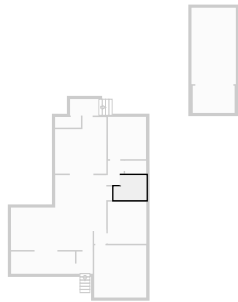

▼ **Toilet**
Ground Floor

WIDTH: 1.66 m • LENGTH: 1.03 m
AREA: 1.70 m² • PERIMETER: 5.36 m

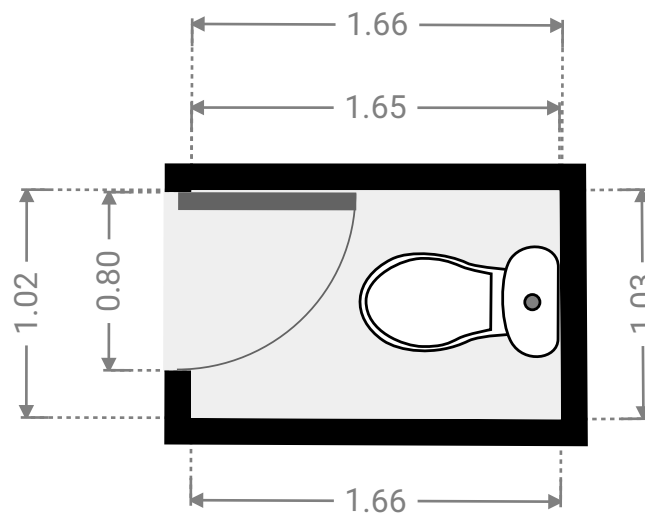
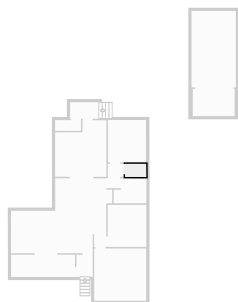

▼ **Bedroom**
Ground Floor

WIDTH: 3.00 m • LENGTH: 3.34 m
AREA: 10.02 m² • PERIMETER: 12.68 m

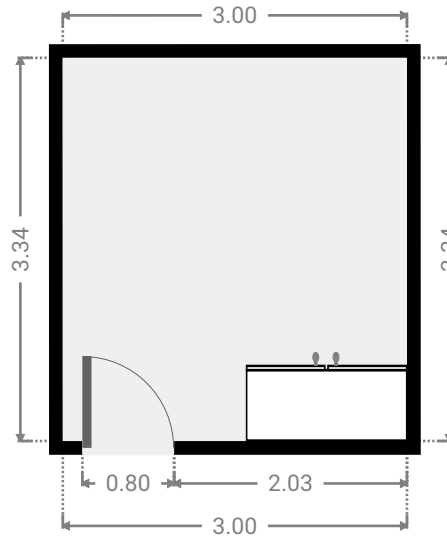
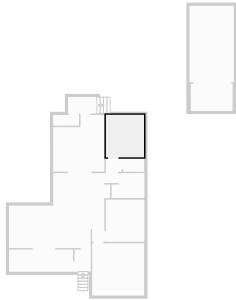

▼ **Kitchen**
Ground Floor

WIDTH: 4.05 m • LENGTH: 4.46 m
AREA: 15.98 m² • PERIMETER: 17.00 m

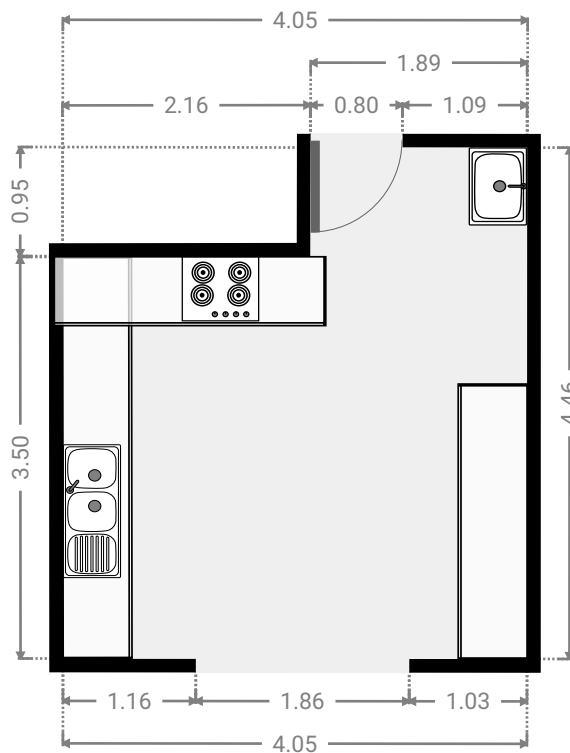
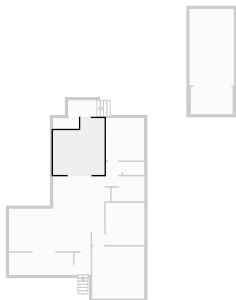

▼ **Hall**
Ground Floor

WIDTH: 2.28 m • LENGTH: 1.30 m
AREA: 2.96 m² • PERIMETER: 7.16 m

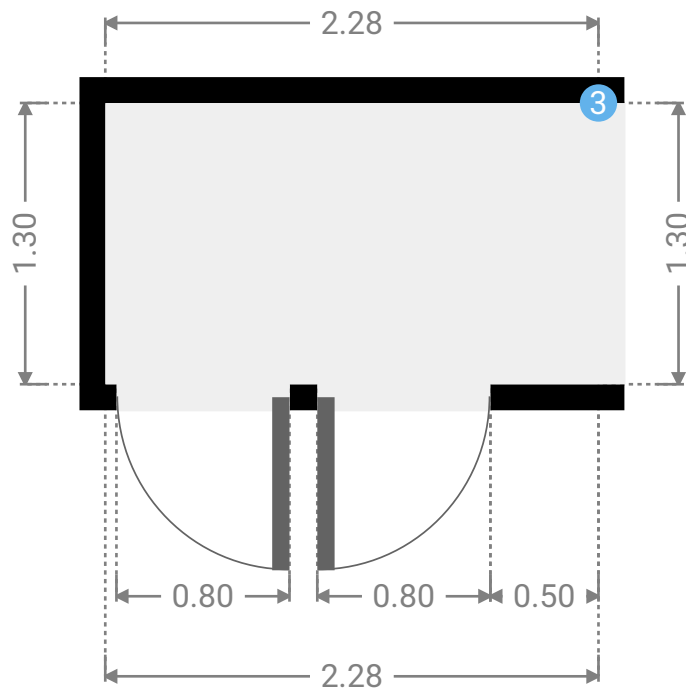
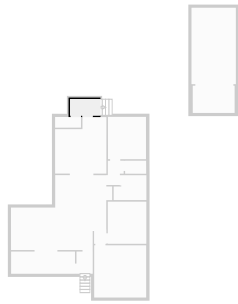

▼ **Hall/Ground Floor**

3 OPENING

Height
0.00 m



▼ **Toilet**
Ground Floor

WIDTH: 2.04 m • LENGTH: 0.85 m
AREA: 1.72 m² • PERIMETER: 5.76 m

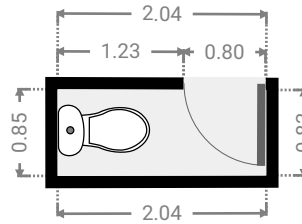
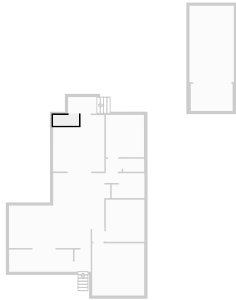

▼ **Garage**
Ground Floor

WIDTH: 3.50 m • LENGTH: 6.03 m
AREA: 21.10 m² • PERIMETER: 19.06 m

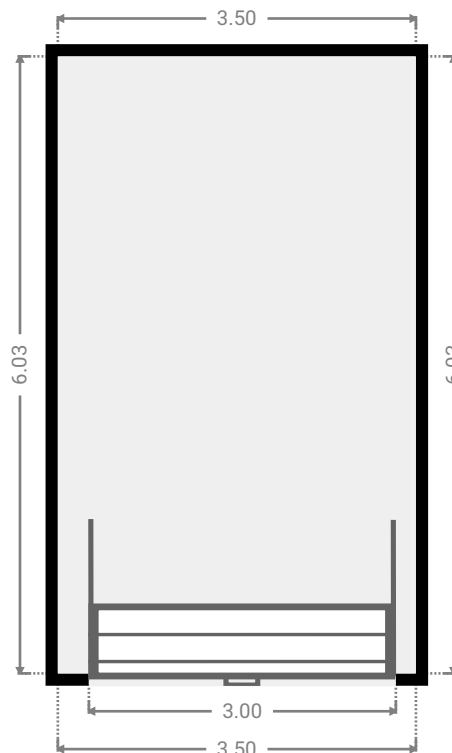
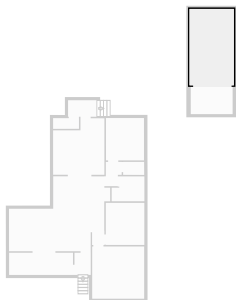

▼ Other
Ground Floor

WIDTH: 3.30 m • LENGTH: 2.15 m
AREA: 7.10 m² • PERIMETER: 10.90 m

