

260 Farm Street

Ground Floor

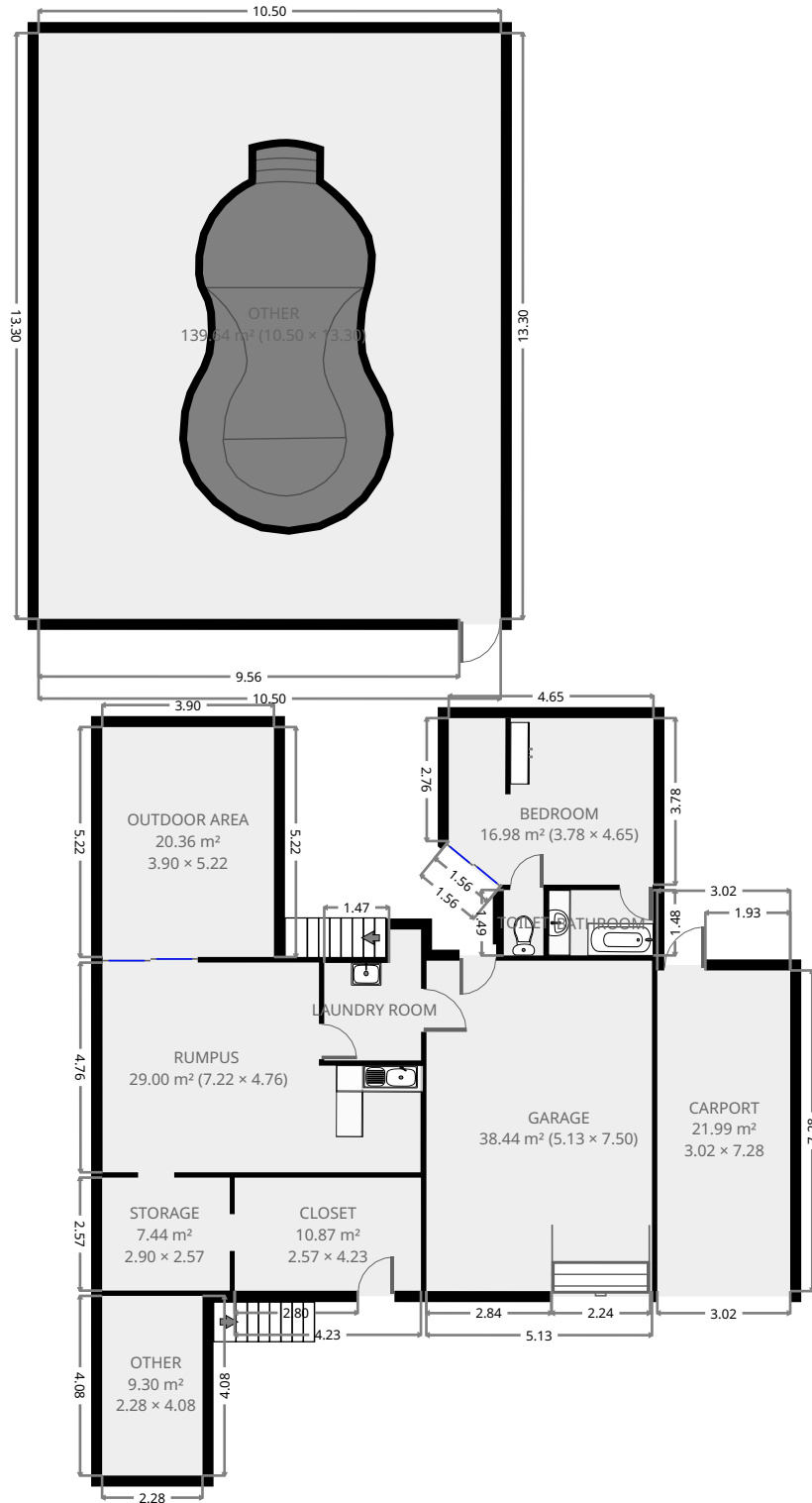

THIS FLOORPLAN IS PROVIDED WITHOUT WARRANTY OF ANY KIND. SENSOPIA DISCLAIMS ANY WARRANTY INCLUDING, WITHOUT LIMITATION, SATISFACTORY QUALITY OR ACCURACY OF DIMENSIONS.



260 Farm Street

Rumpus

Width: 4.76 m
 Length: 7.22 m
 Area: 29.00 m²
 Perimeter: 23.97 m

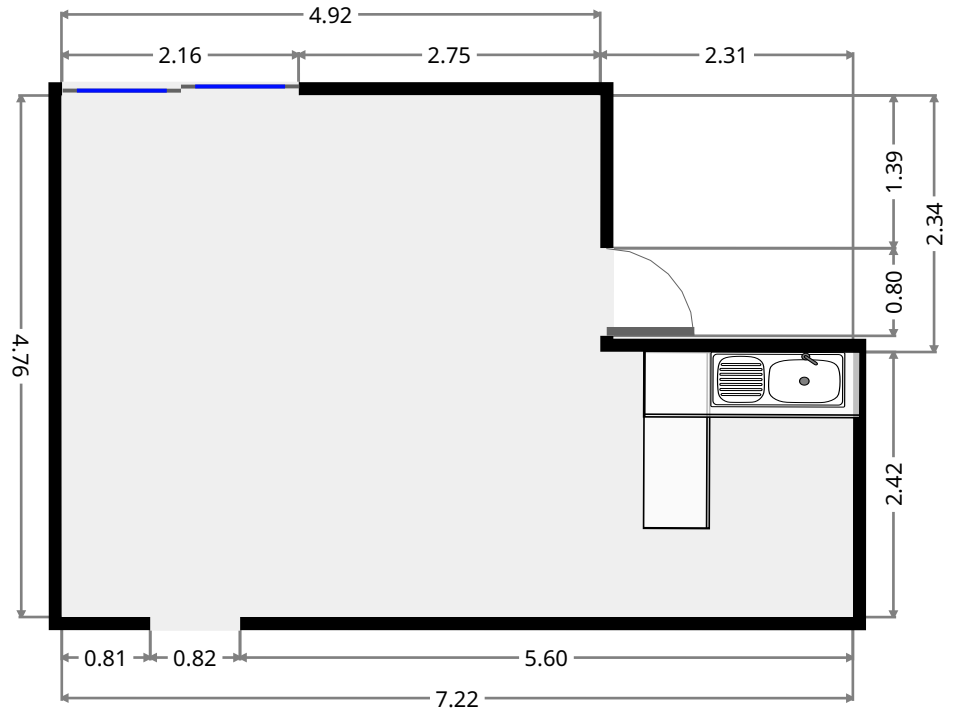
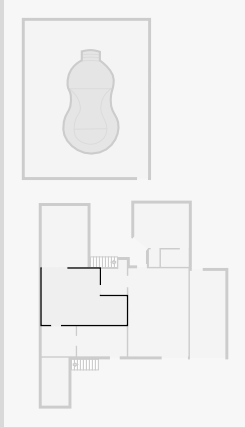

Laundry Room

Width: 2.20 m
 Length: 2.97 m
 Area: 5.42 m²
 Perimeter: 10.34 m

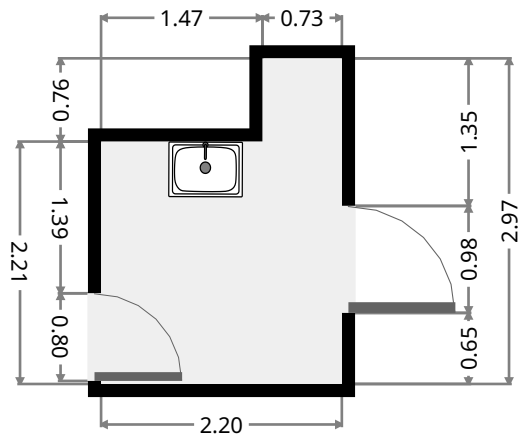
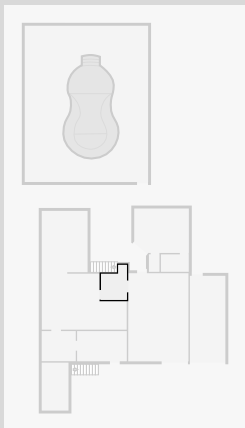

THIS FLOORPLAN IS PROVIDED WITHOUT WARRANTY OF ANY KIND. SENSOPIA DISCLAIMS ANY WARRANTY INCLUDING, WITHOUT LIMITATION, SATISFACTORY QUALITY OR ACCURACY OF DIMENSIONS.

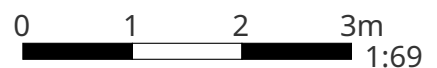

260 Farm Street

Garage

Width: 5.13 m
 Length: 7.50 m
 Area: 38.44 m²
 Perimeter: 25.25 m

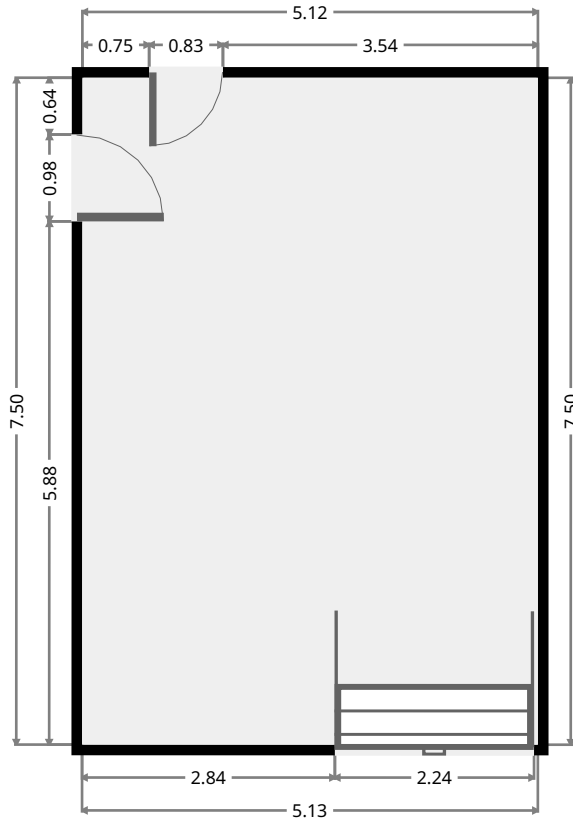
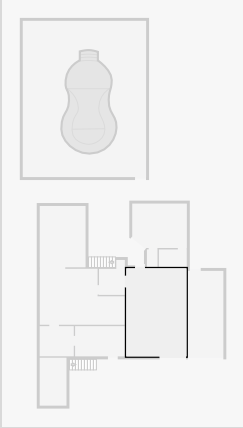

Storage

Width: 2.57 m
 Length: 2.90 m
 Area: 7.44 m²
 Perimeter: 10.93 m

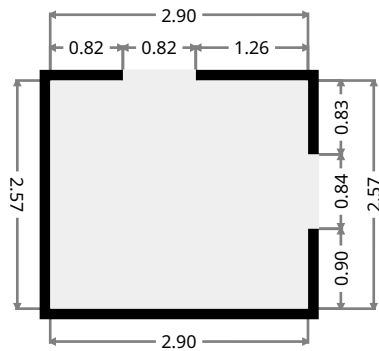
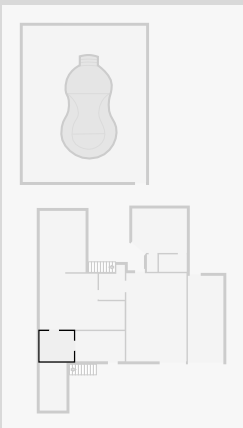

260 Farm Street

Closet

Width: 2.57 m
 Length: 4.23 m
 Area: 10.87 m²
 Perimeter: 13.60 m

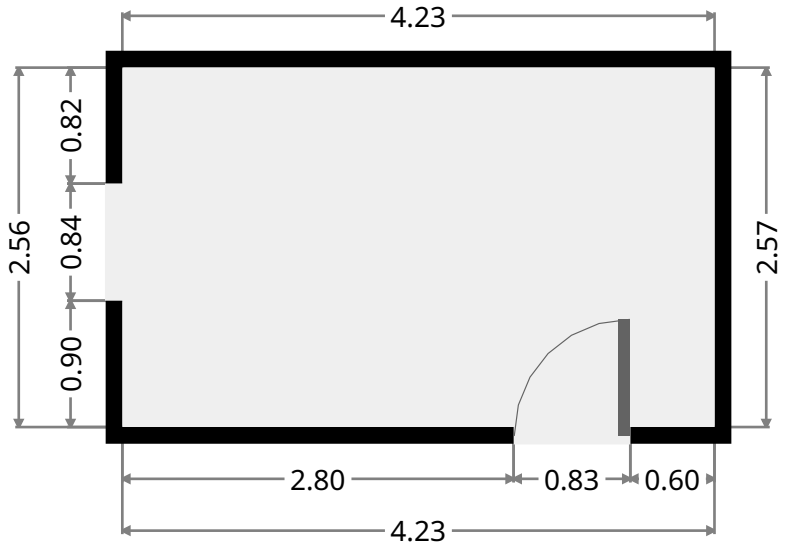
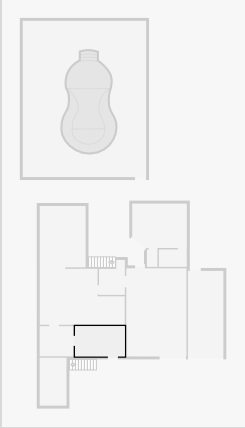

Bedroom

Width: 3.78 m
 Length: 4.65 m
 Area: 16.98 m²
 Perimeter: 16.23 m

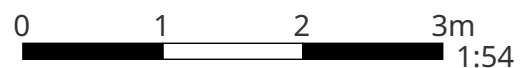
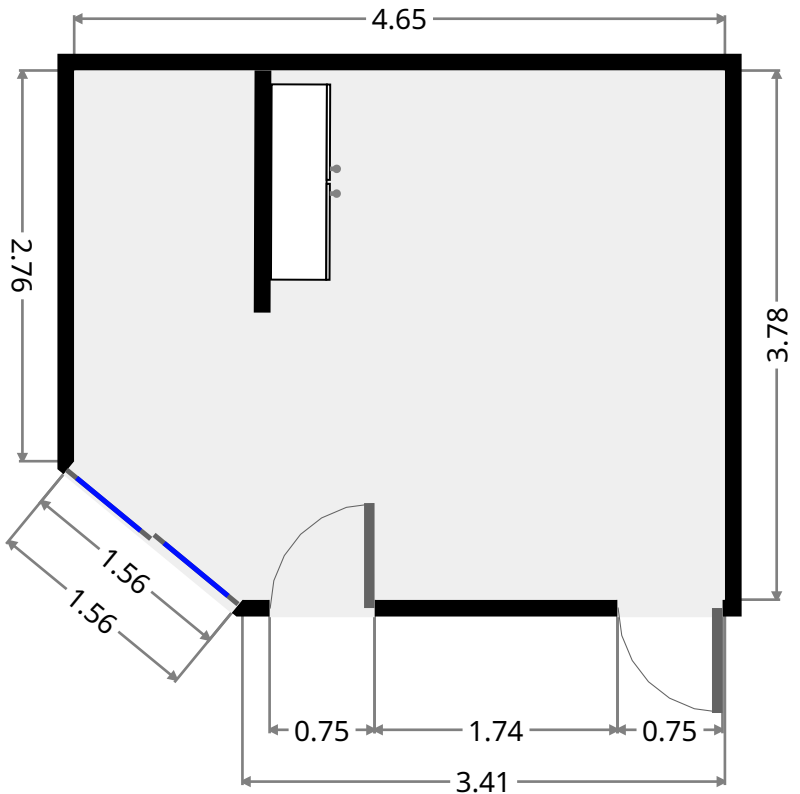
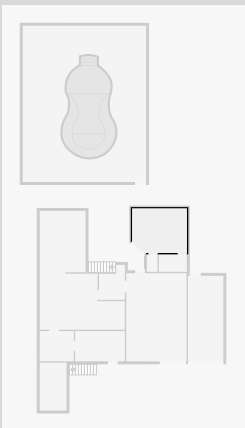

THIS FLOORPLAN IS PROVIDED WITHOUT WARRANTY OF ANY KIND. SENSOPIA DISCLAIMS ANY WARRANTY INCLUDING, WITHOUT LIMITATION, SATISFACTORY QUALITY OR ACCURACY OF DIMENSIONS.

260 Farm Street

Bathroom

Width: 1.48 m
Length: 2.37 m
Area: 3.51 m²
Perimeter: 7.70 m

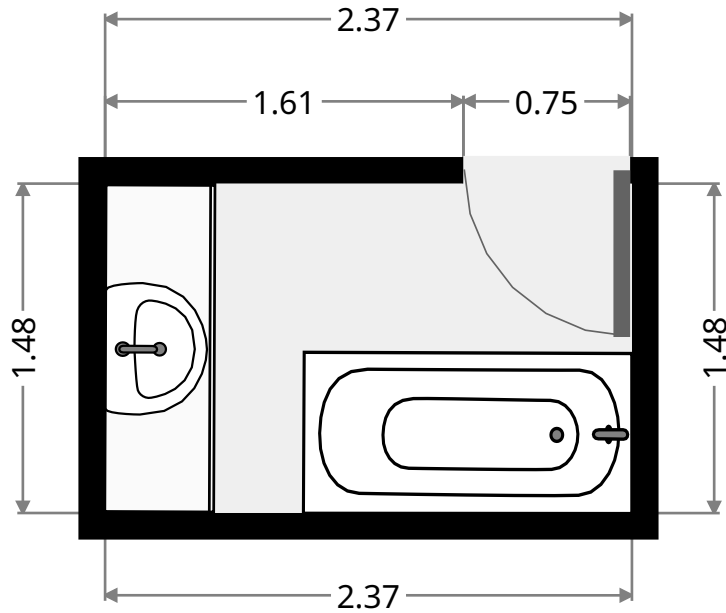
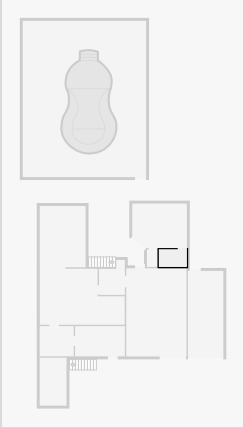

Toilet

Width: 0.90 m
Length: 1.49 m
Area: 1.34 m²
Perimeter: 4.78 m

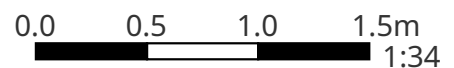
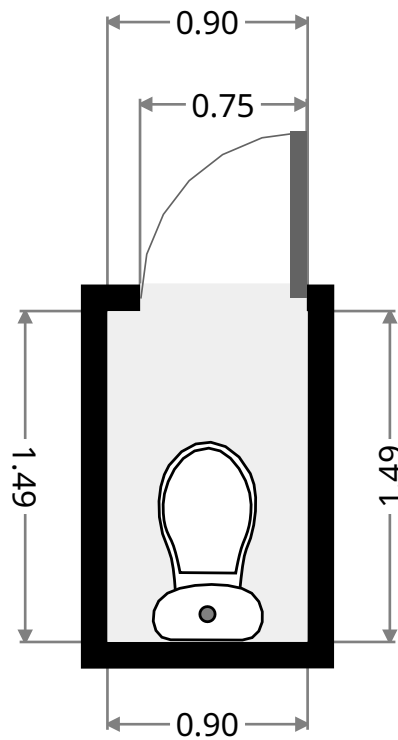
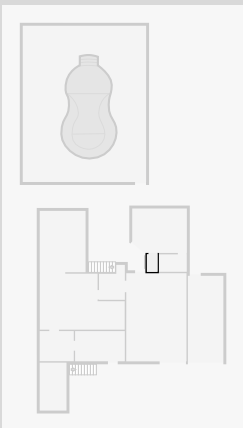

260 Farm Street

Outdoor Area

Width: 3.90 m
Length: 5.22 m
Area: 20.36 m²
Perimeter: 18.24 m

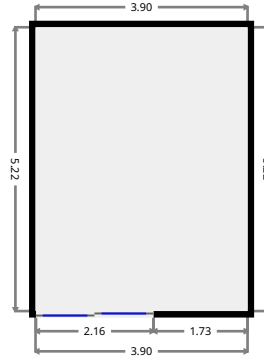
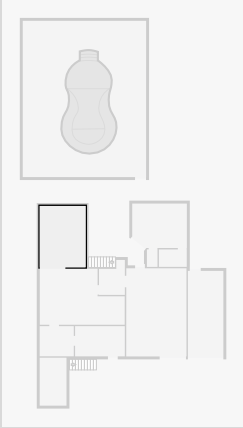

Other

Width: 10.50 m
Length: 13.30 m
Area: 139.64 m²
Perimeter: 47.60 m

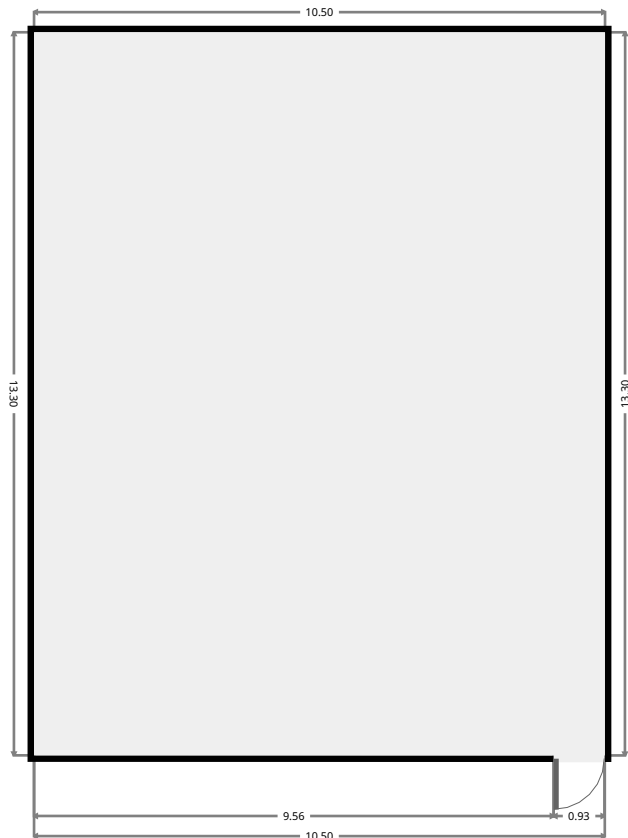
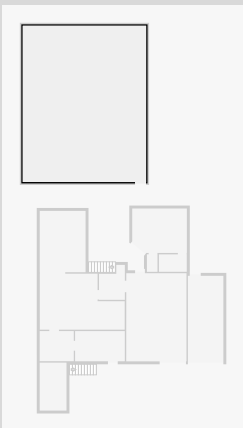

THIS FLOORPLAN IS PROVIDED WITHOUT WARRANTY OF ANY KIND. SENSOPIA DISCLAIMS ANY WARRANTY INCLUDING, WITHOUT LIMITATION, SATISFACTORY QUALITY OR ACCURACY OF DIMENSIONS.

260 Farm Street

Other

Width: 2.28 m
Length: 4.08 m
Area: 9.30 m²
Perimeter: 12.72 m

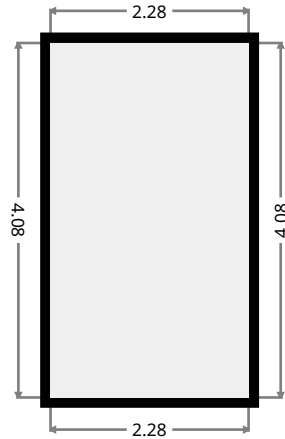
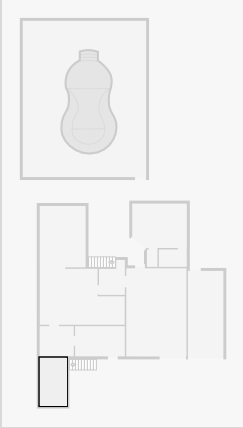

Carport

Width: 3.02 m
Length: 7.28 m
Area: 21.99 m²
Perimeter: 20.60 m

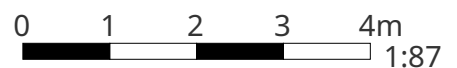
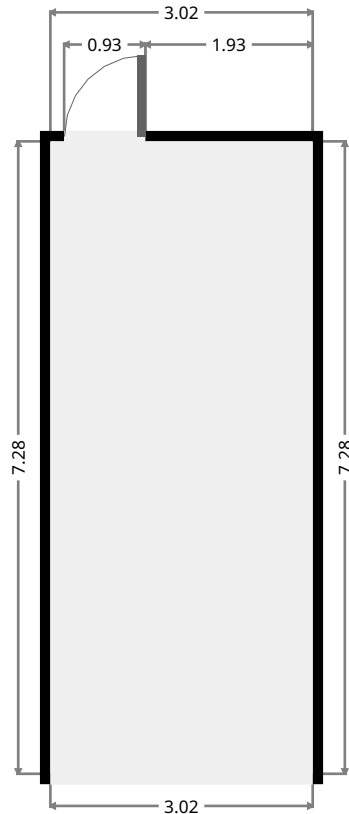
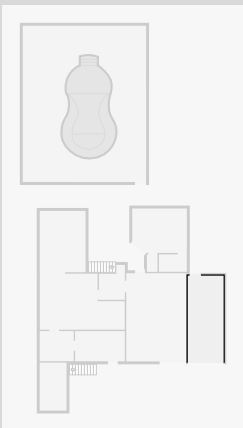

260 Farm Street

1st Floor

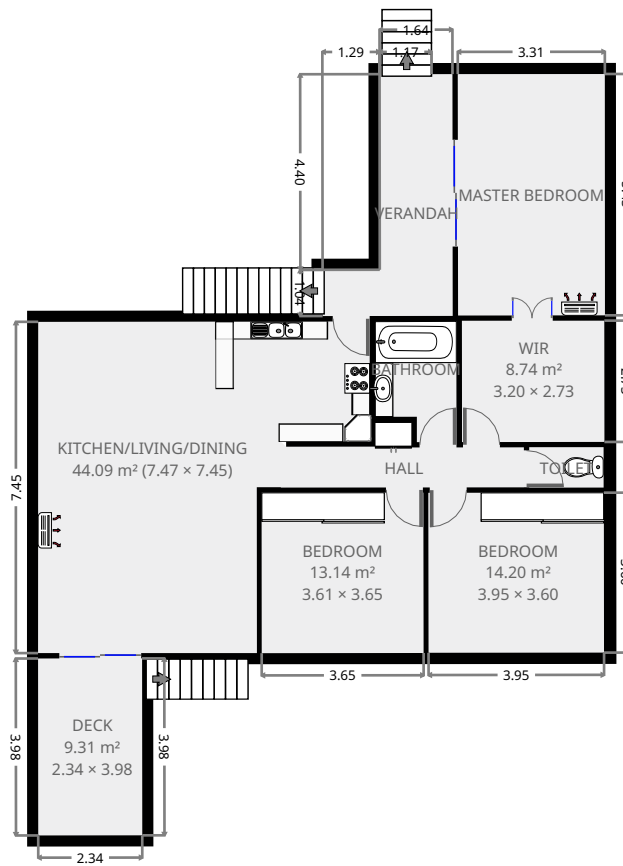

THIS FLOORPLAN IS PROVIDED WITHOUT WARRANTY OF ANY KIND. SENSOPIA DISCLAIMS ANY WARRANTY INCLUDING, WITHOUT LIMITATION, SATISFACTORY QUALITY OR ACCURACY OF DIMENSIONS.



260 Farm Street

Kitchen/Living/Dining

Width: 7.45 m
 Length: 7.47 m
 Area: 44.09 m²
 Perimeter: 29.83 m

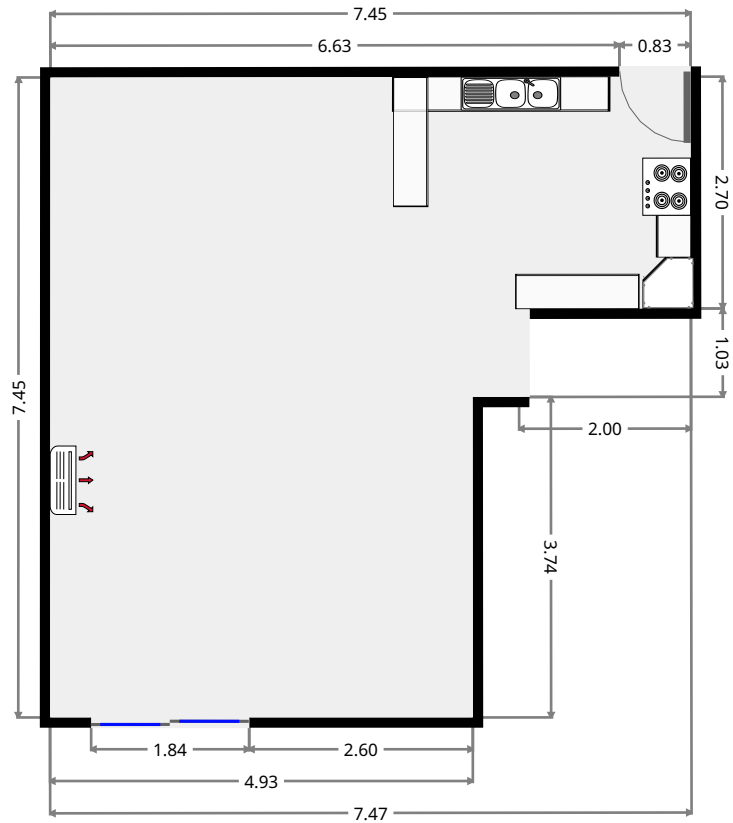
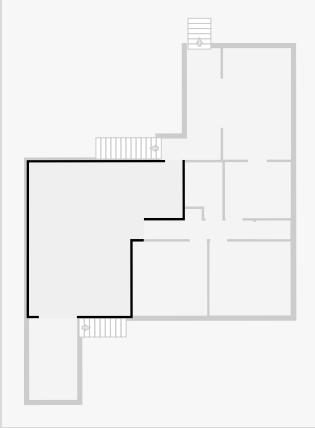

Hall

Width: 1.47 m
 Length: 5.35 m
 Area: 5.32 m²
 Perimeter: 13.64 m

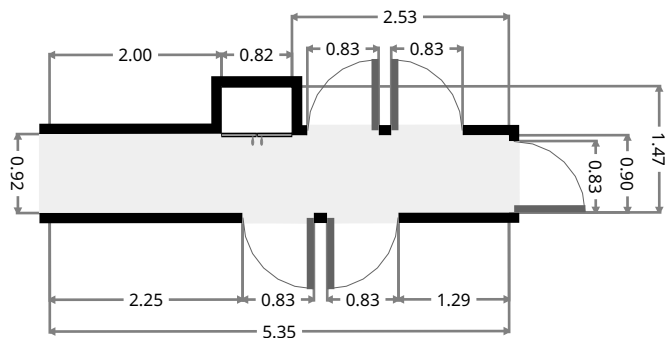
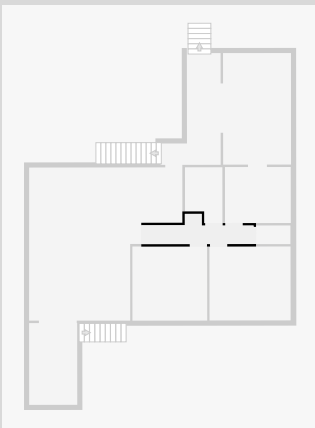

THIS FLOORPLAN IS PROVIDED WITHOUT WARRANTY OF ANY KIND. SENSOPIA DISCLAIMS ANY WARRANTY INCLUDING, WITHOUT LIMITATION, SATISFACTORY QUALITY OR ACCURACY OF DIMENSIONS.



260 Farm Street

Bedroom

Width: 3.61 m
 Length: 3.65 m
 Area: 13.14 m²
 Perimeter: 14.50 m

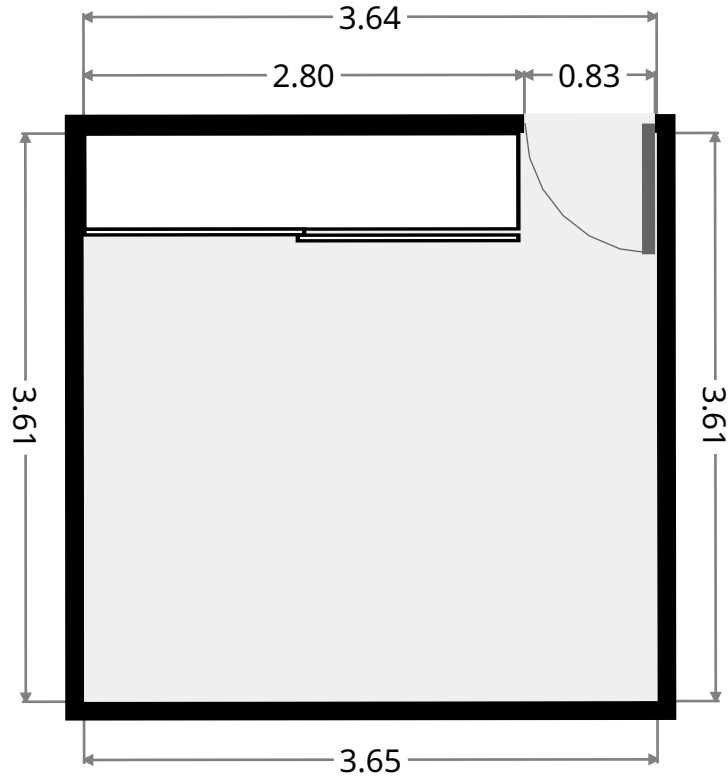
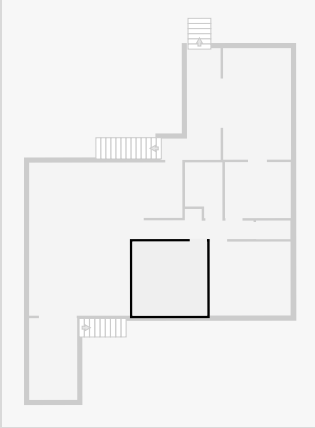

Bedroom

Width: 3.60 m
 Length: 3.95 m
 Area: 14.20 m²
 Perimeter: 15.09 m

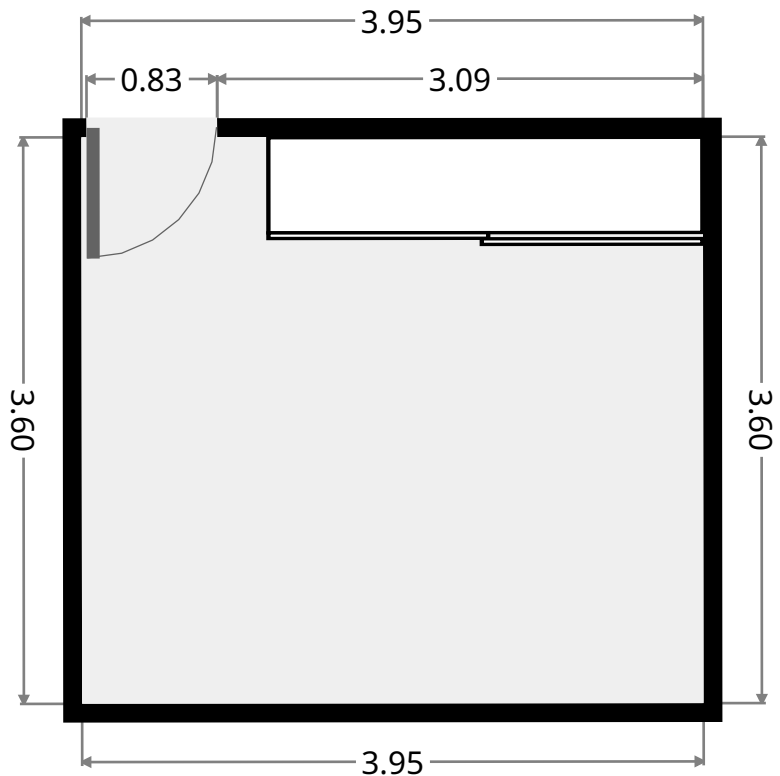
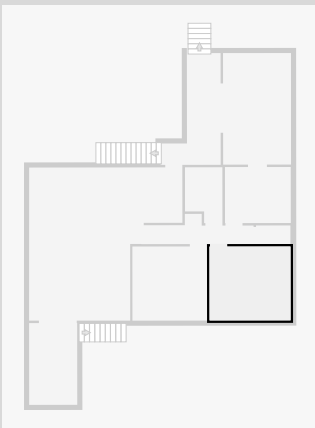

THIS FLOORPLAN IS PROVIDED WITHOUT WARRANTY OF ANY KIND. SENSOPIA DISCLAIMS ANY WARRANTY INCLUDING, WITHOUT LIMITATION, SATISFACTORY QUALITY OR ACCURACY OF DIMENSIONS.

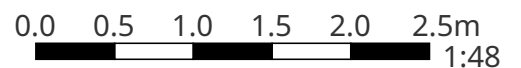

260 Farm Street

Toilet

Width: 0.91 m
Length: 1.67 m
Area: 1.52 m²
Perimeter: 5.16 m

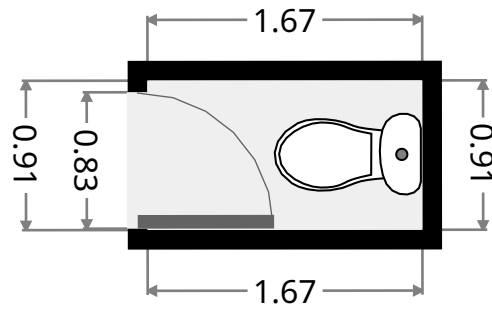
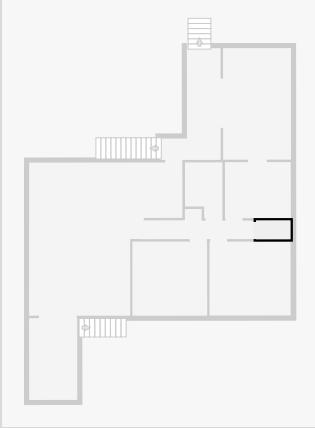

WIR

Width: 2.73 m
Length: 3.20 m
Area: 8.74 m²
Perimeter: 11.86 m

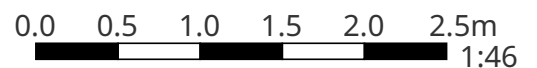
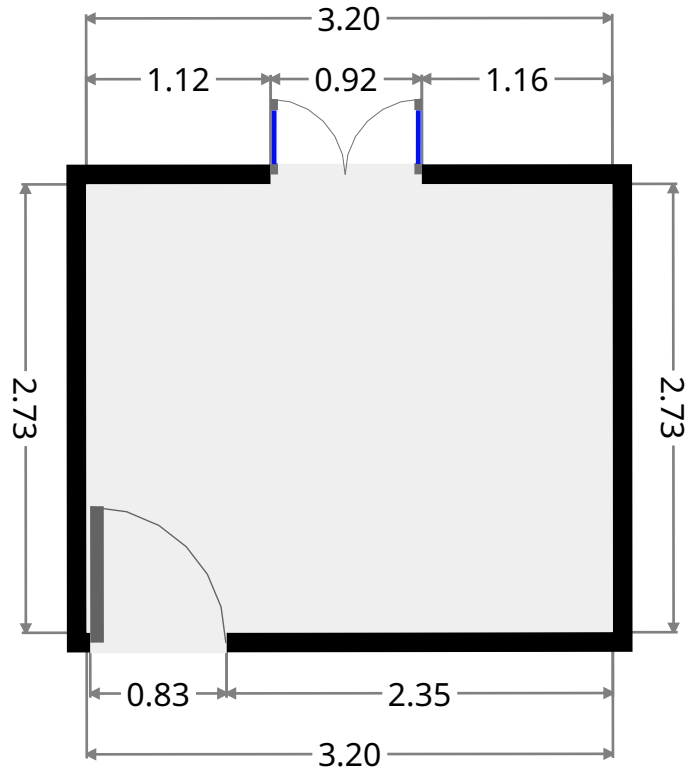
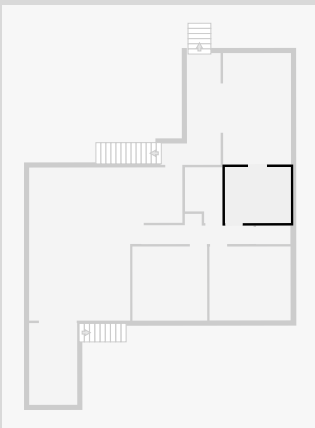

260 Farm Street

Master Bedroom

Width: 3.30 m
Length: 5.43 m
Area: 17.95 m²
Perimeter: 17.47 m

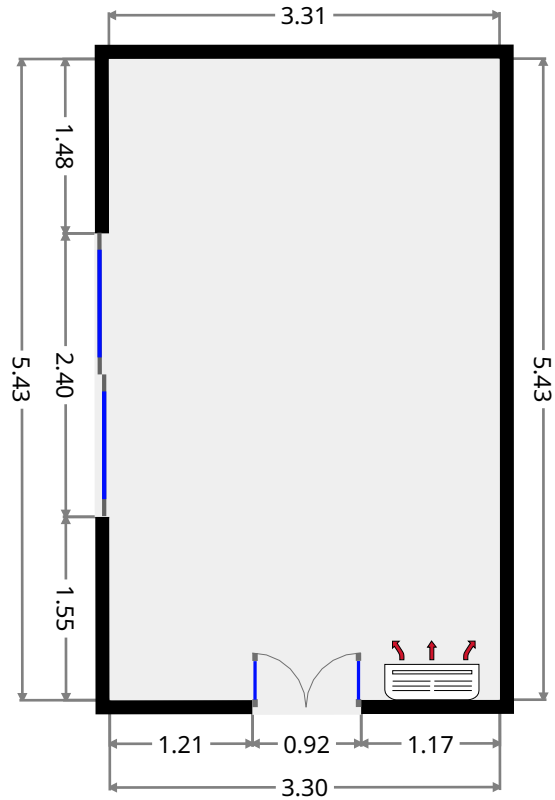
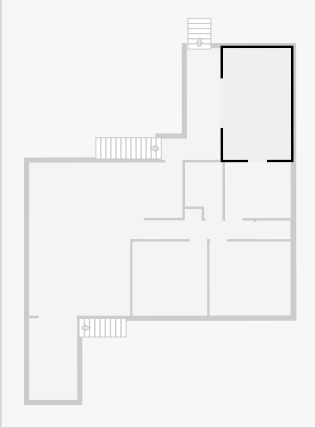

Bathroom

Width: 1.82 m
Length: 2.72 m
Area: 4.42 m²
Perimeter: 9.08 m

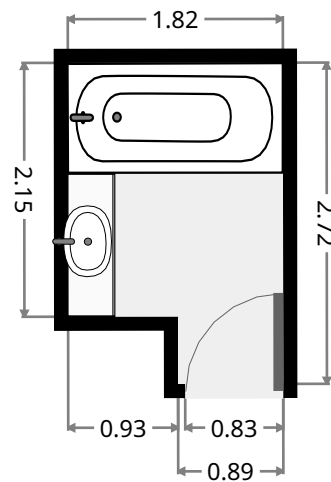
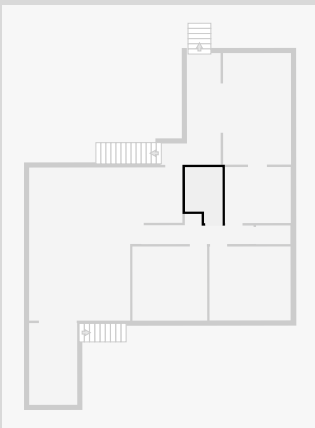

260 Farm Street

Verandah

Width: 2.93 m
Length: 5.44 m
Area: 10.26 m²
Perimeter: 16.73 m

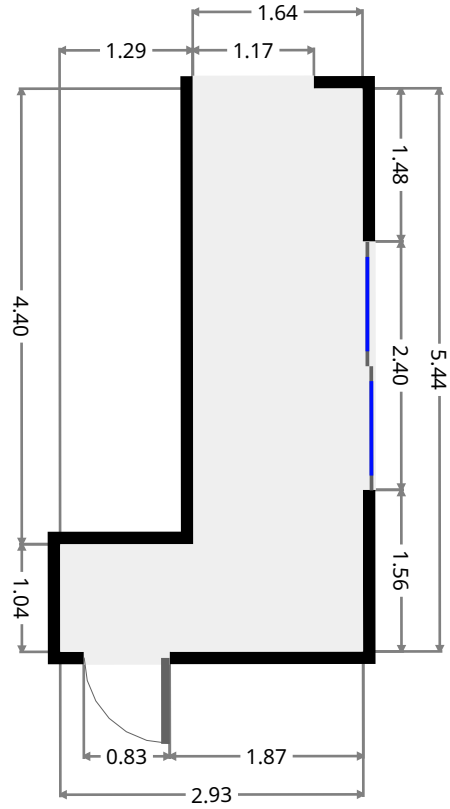
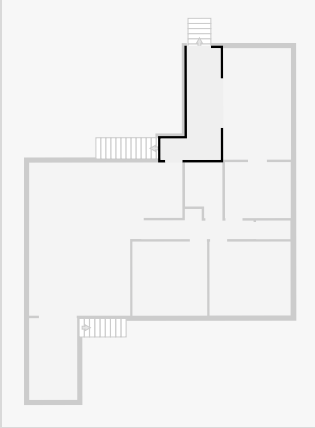

Deck

Width: 2.34 m
Length: 3.98 m
Area: 9.31 m²
Perimeter: 12.64 m

