

26 Govind Court

Ground Floor

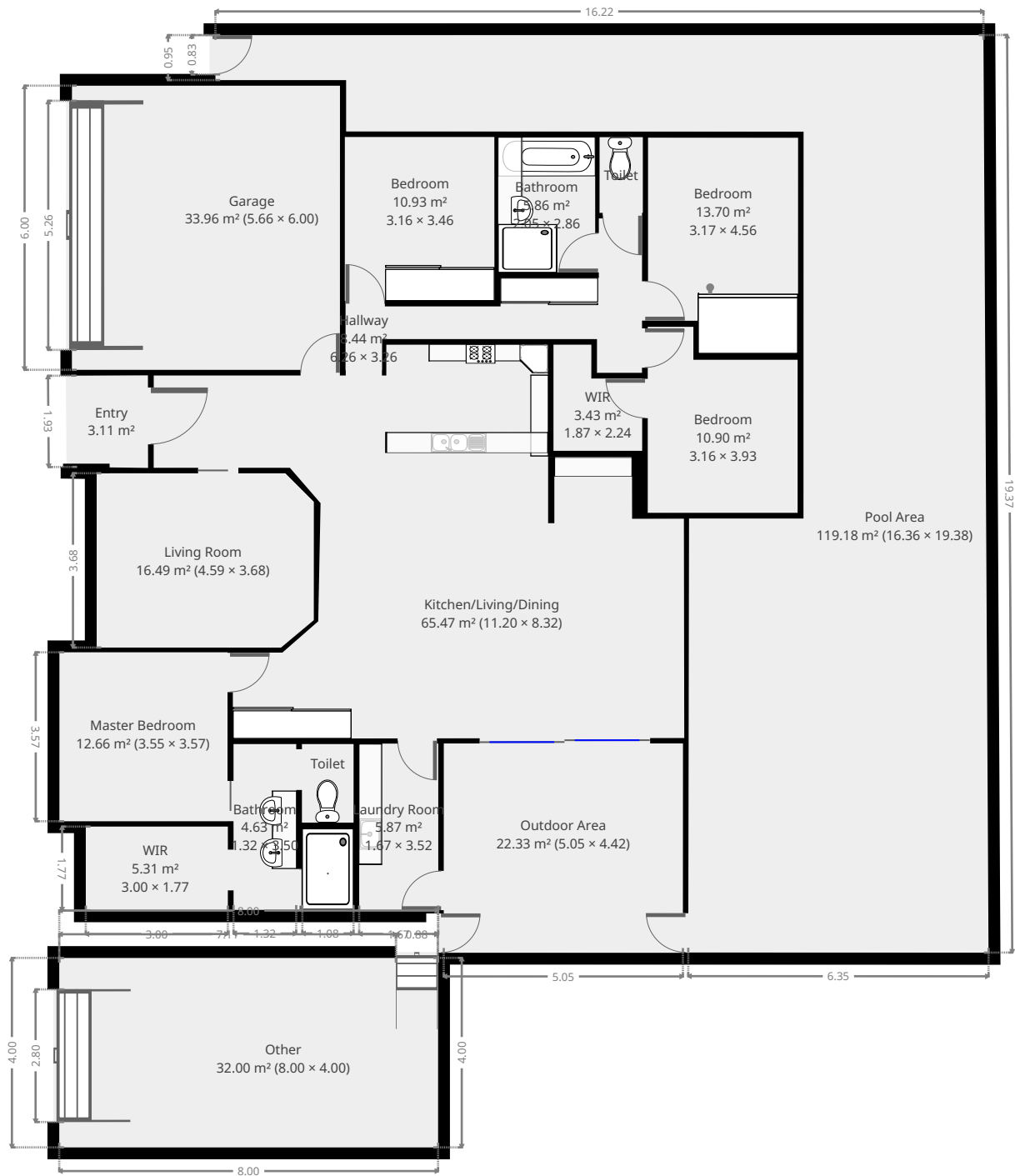

THIS FLOORPLAN IS PROVIDED WITHOUT WARRANTY OF ANY KIND. SENSOPIA DISCLAIMS ANY WARRANTY INCLUDING, WITHOUT LIMITATION, SATISFACTORY QUALITY OR ACCURACY OF DIMENSIONS.



26 Govind Court

Bedroom

Width: 3.17 m
 Length: 4.56 m
 Area: 13.70 m²
 Perimeter: 15.46 m

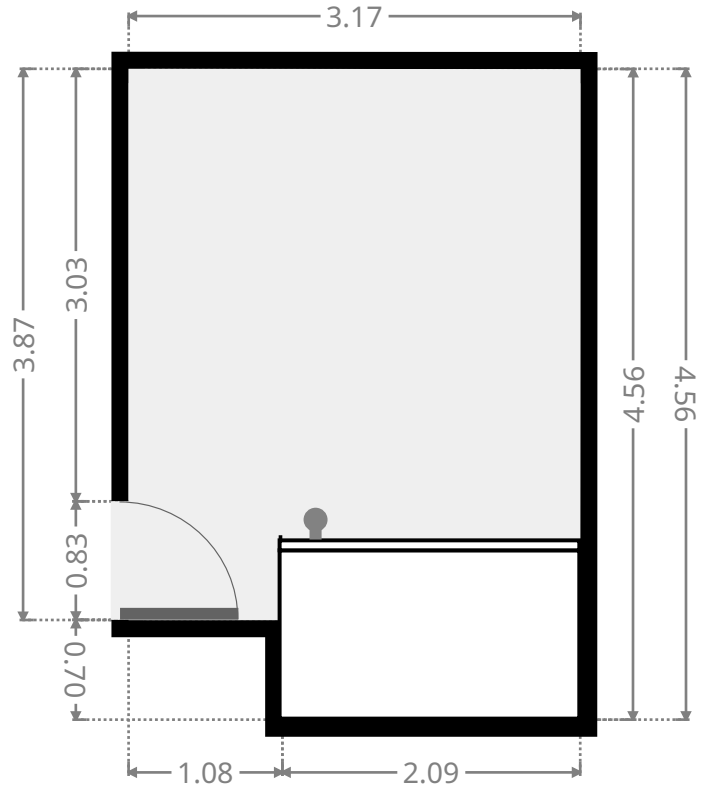
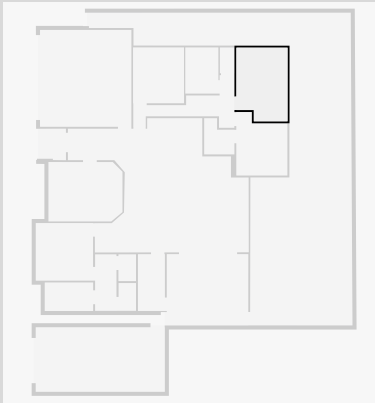

Entry

Width: 1.61 m
 Length: 1.96 m
 Area: 3.11 m²
 Perimeter: 7.09 m

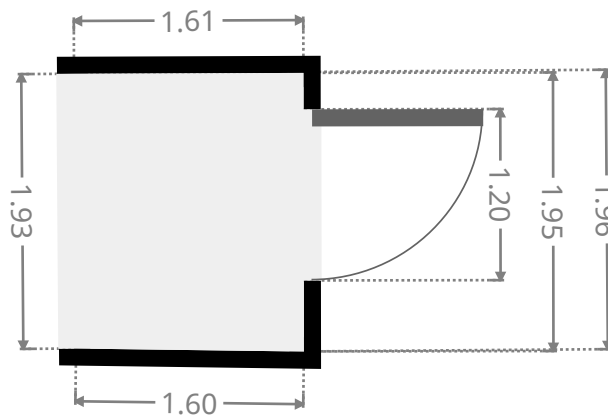
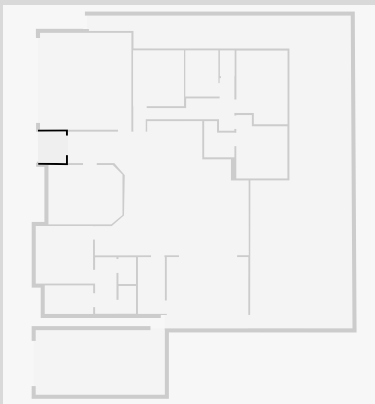

26 Govind Court

Pool Area

Width: 16.36 m
Length: 19.38 m
Area: 119.18 m²
Perimeter: 76.14 m

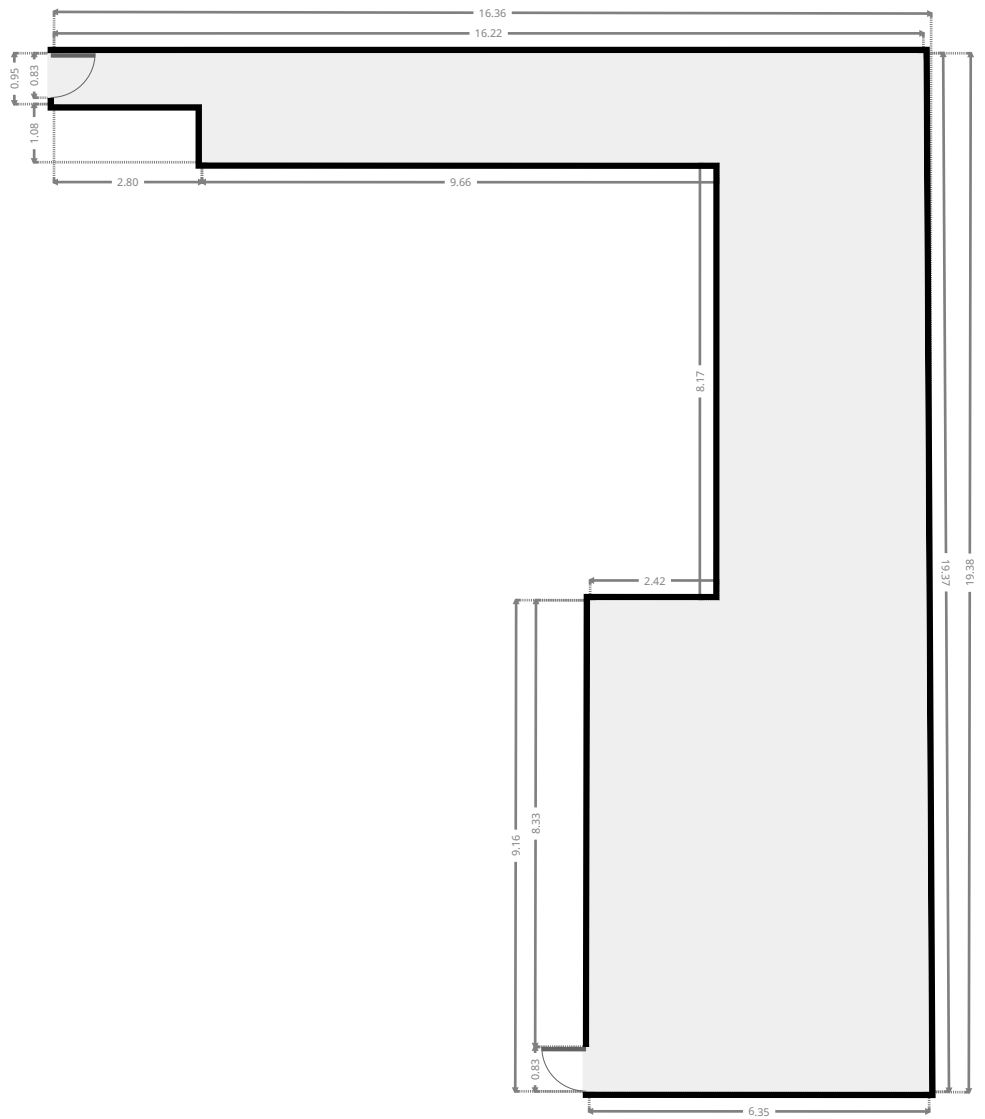
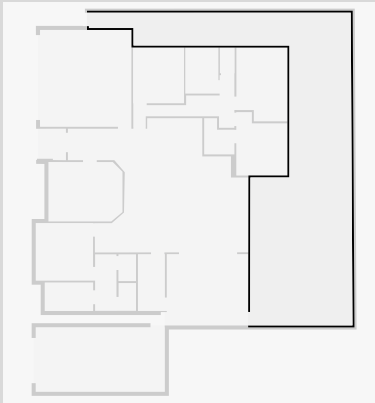

26 Govind Court

Other

Width: 4.00 m
 Length: 8.00 m
 Area: 32.00 m²
 Perimeter: 24.00 m

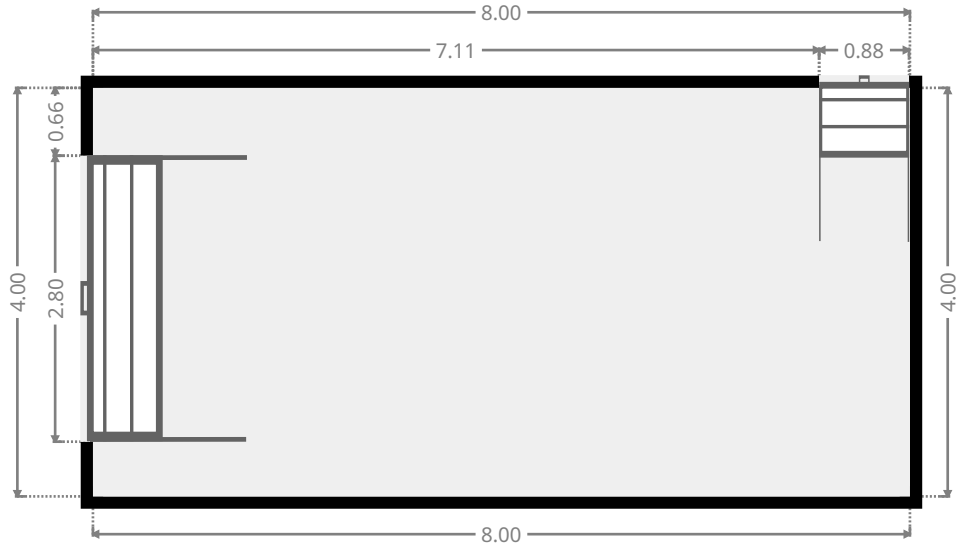
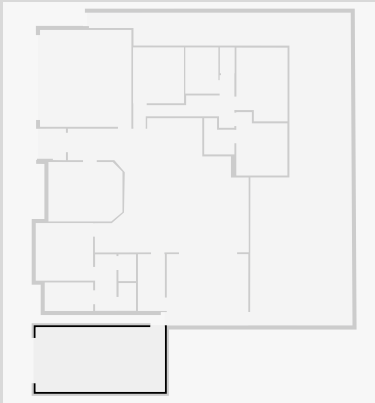

Laundry Room

Width: 1.67 m
 Length: 3.52 m
 Area: 5.87 m²
 Perimeter: 10.38 m

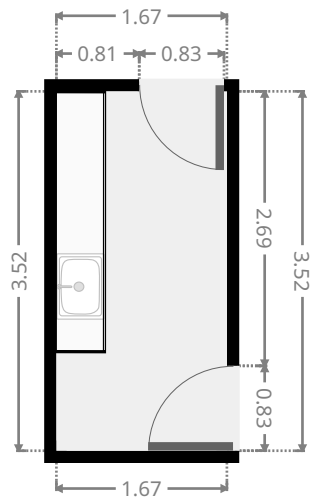

26 Govind Court

Outdoor Area

Width: 4.42 m
 Length: 5.05 m
 Area: 22.33 m²
 Perimeter: 18.94 m

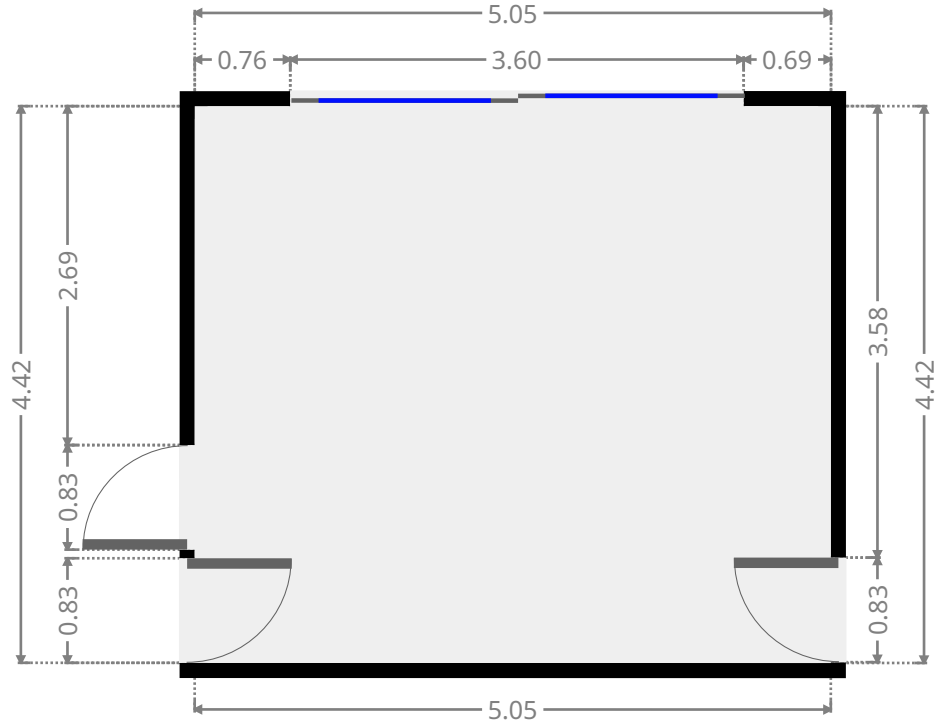
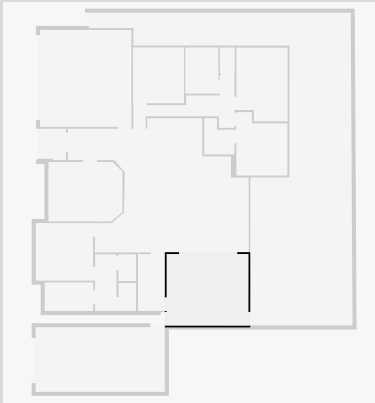

Living Room

Width: 3.68 m
 Length: 4.59 m
 Area: 16.49 m²
 Perimeter: 15.81 m

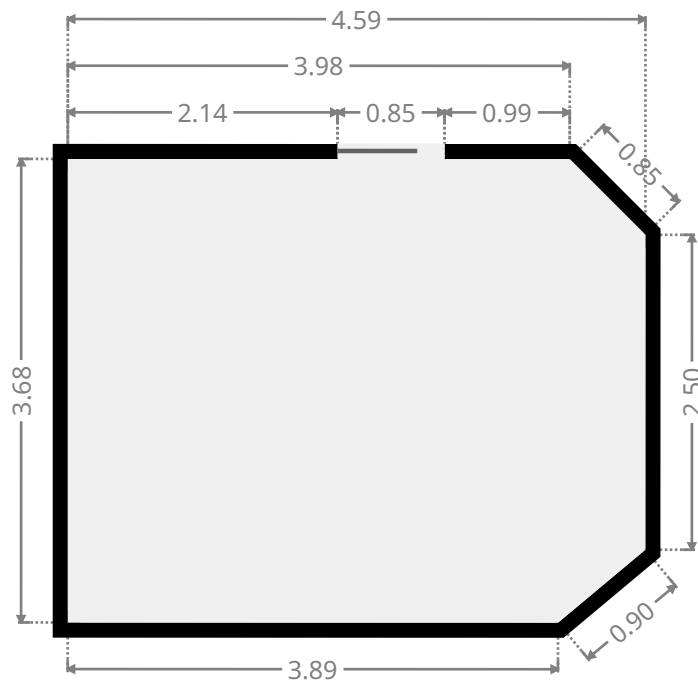
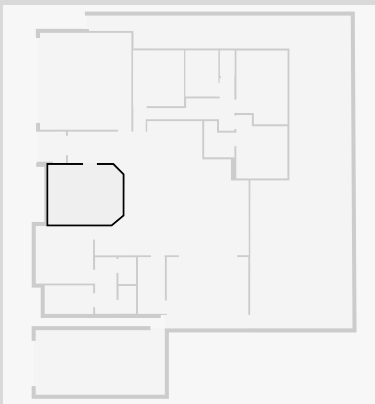

26 Govind Court

Bedroom

Width: 3.16 m
Length: 3.46 m
Area: 10.93 m²
Perimeter: 13.24 m

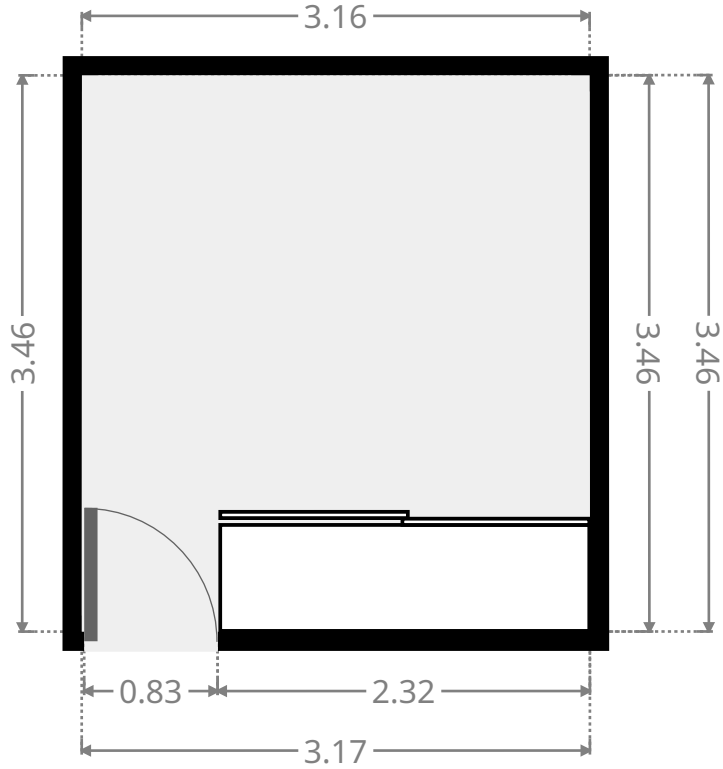

Bathroom

Width: 2.05 m
Length: 2.86 m
Area: 5.86 m²
Perimeter: 9.82 m

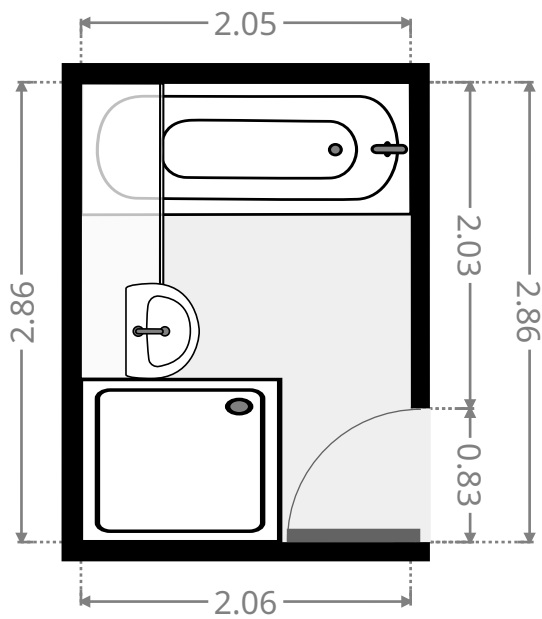

THIS FLOORPLAN IS PROVIDED WITHOUT WARRANTY OF ANY KIND. SENSOPIA DISCLAIMS ANY WARRANTY INCLUDING, WITHOUT LIMITATION, SATISFACTORY QUALITY OR ACCURACY OF DIMENSIONS.

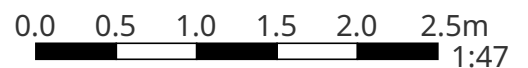

26 Govind Court

Toilet / Half Bath

Width: 0.91 m
 Length: 1.60 m
 Area: 1.46 m²
 Perimeter: 5.02 m

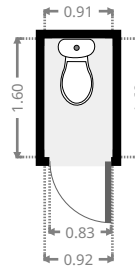

Kitchen/Living/Dining

Width: 8.32 m
 Length: 11.20 m
 Area: 65.47 m²
 Perimeter: 41.86 m

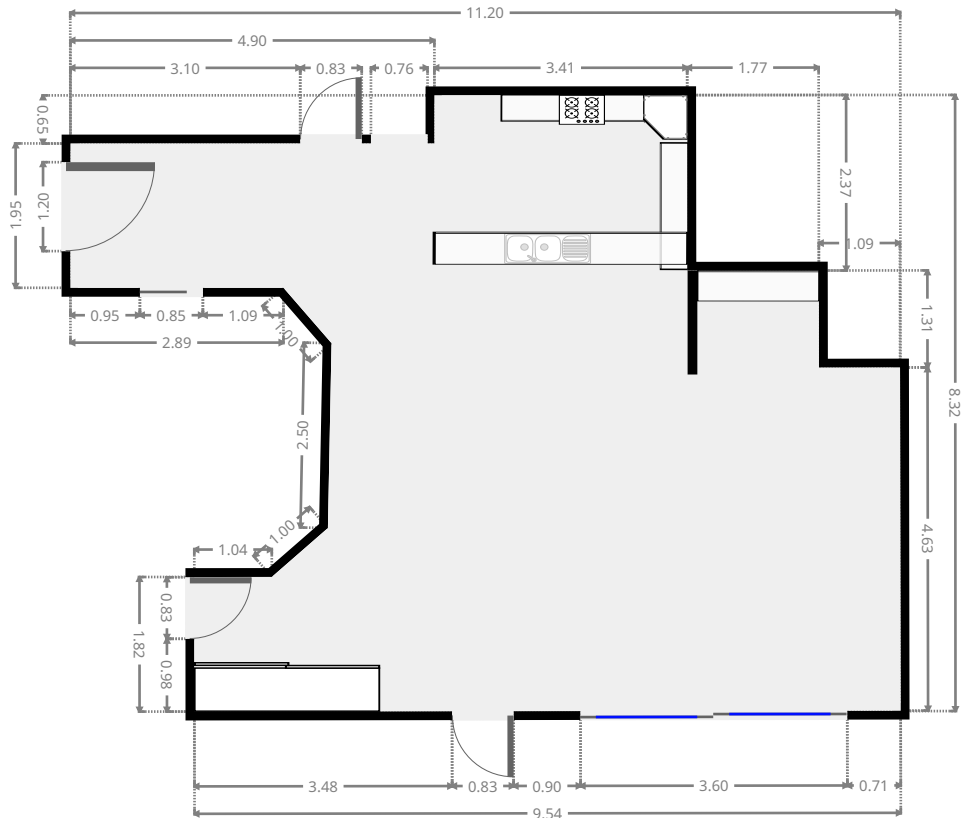
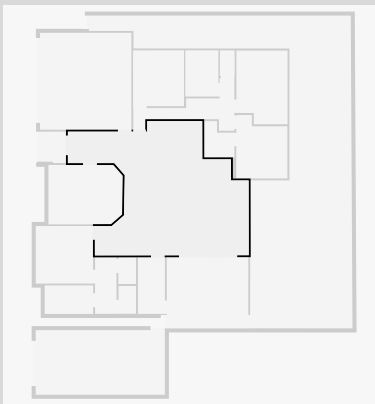

THIS FLOORPLAN IS PROVIDED WITHOUT WARRANTY OF ANY KIND. SENSOPIA DISCLAIMS ANY WARRANTY INCLUDING, WITHOUT LIMITATION, SATISFACTORY QUALITY OR ACCURACY OF DIMENSIONS.

26 Govind Court

WIR

Width: 1.87 m
 Length: 2.24 m
 Area: 3.43 m²
 Perimeter: 8.23 m

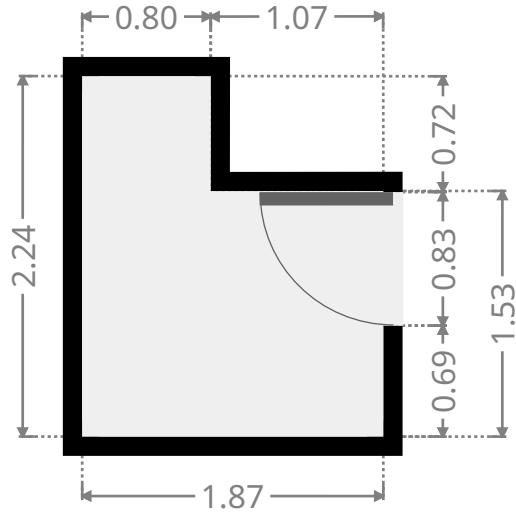
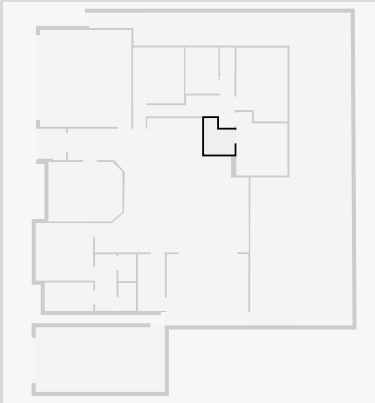

Bedroom

Width: 3.16 m
 Length: 3.93 m
 Area: 10.90 m²
 Perimeter: 14.18 m

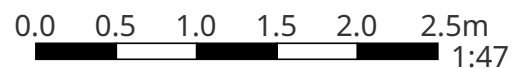
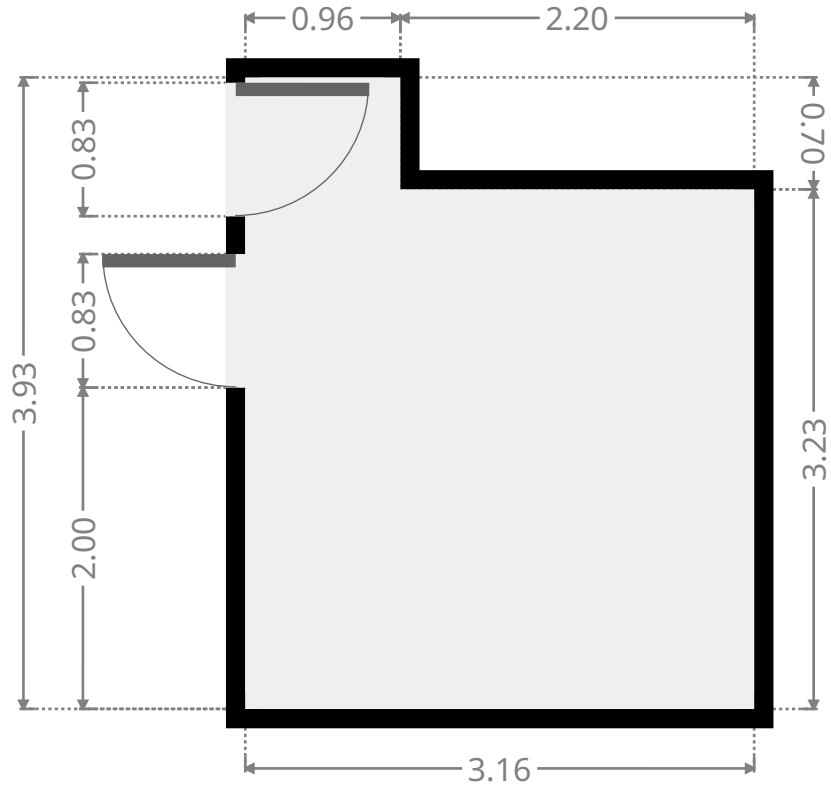
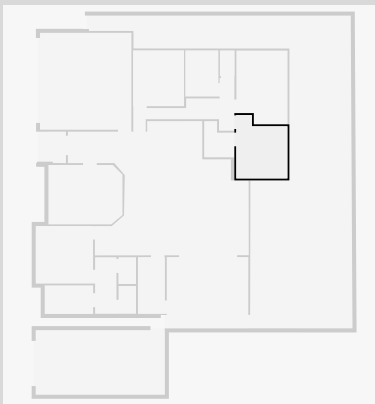

THIS FLOORPLAN IS PROVIDED WITHOUT WARRANTY OF ANY KIND. SENSOPIA DISCLAIMS ANY WARRANTY INCLUDING, WITHOUT LIMITATION, SATISFACTORY QUALITY OR ACCURACY OF DIMENSIONS.

26 Govind Court

Hallway

Width: 3.26 m
 Length: 6.26 m
 Area: 8.44 m²
 Perimeter: 20.36 m

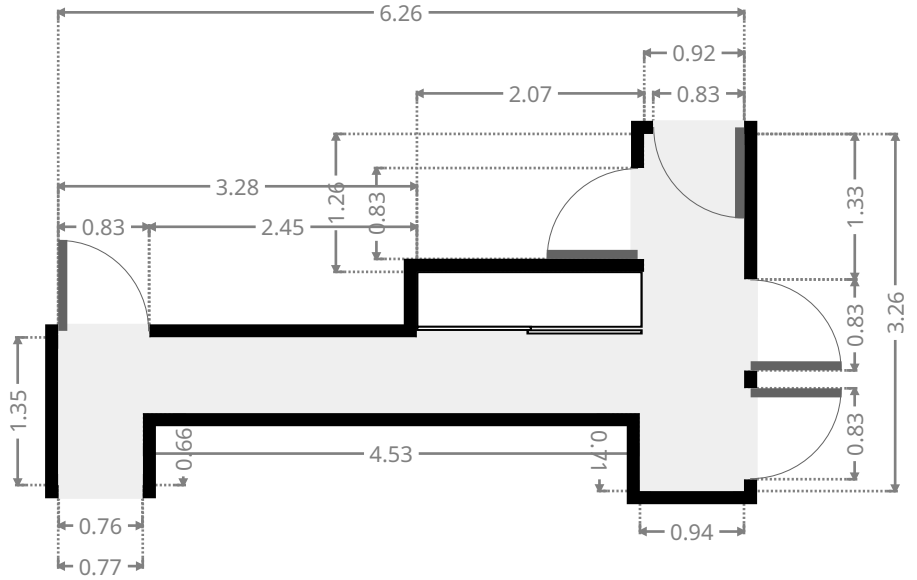
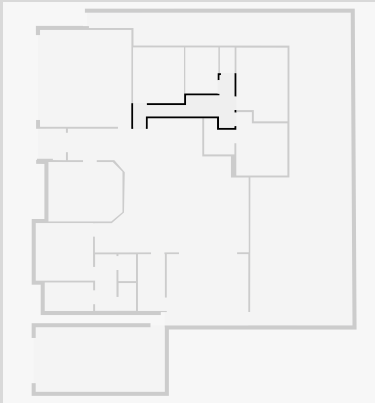

Garage

Width: 5.66 m
 Length: 6.00 m
 Area: 33.96 m²
 Perimeter: 23.32 m

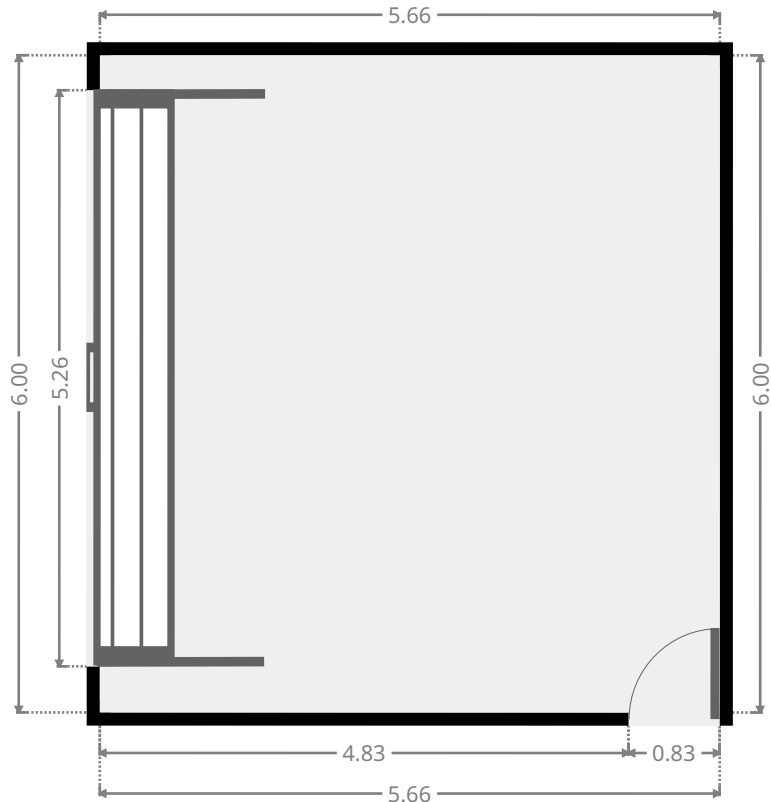
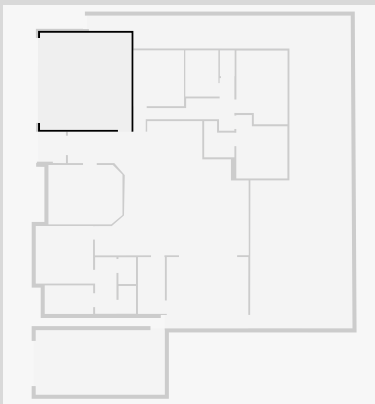

THIS FLOORPLAN IS PROVIDED WITHOUT WARRANTY OF ANY KIND. SENSOPIA DISCLAIMS ANY WARRANTY INCLUDING, WITHOUT LIMITATION, SATISFACTORY QUALITY OR ACCURACY OF DIMENSIONS.

26 Govind Court

WIR

Width: 1.77 m
 Length: 3.00 m
 Area: 5.31 m²
 Perimeter: 9.54 m

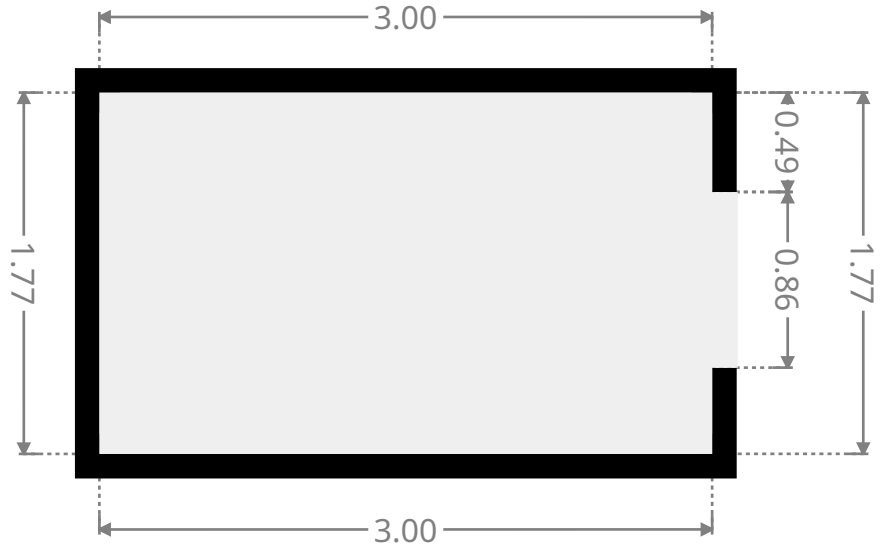

Toilet / Half Bath

Width: 1.09 m
 Length: 1.66 m
 Area: 1.81 m²
 Perimeter: 5.50 m

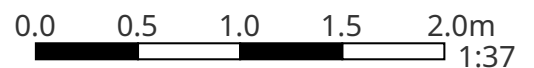
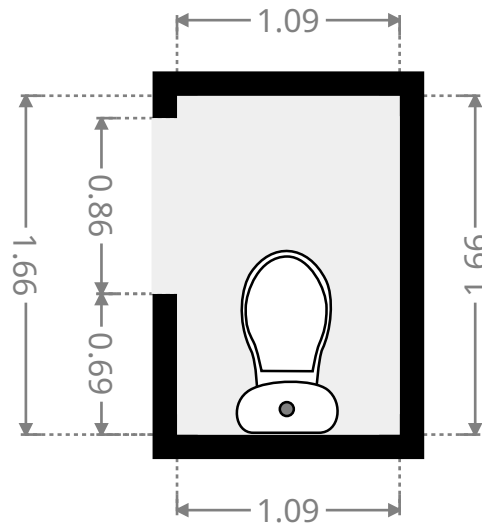

THIS FLOORPLAN IS PROVIDED WITHOUT WARRANTY OF ANY KIND. SENSOPIA DISCLAIMS ANY WARRANTY INCLUDING, WITHOUT LIMITATION, SATISFACTORY QUALITY OR ACCURACY OF DIMENSIONS.

26 Govind Court

•
 Width: 1.08 m
 Length: 1.72 m
 Area: 1.86 m²
 Perimeter: 5.60 m

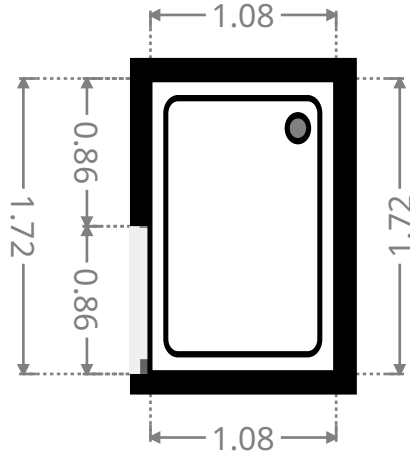
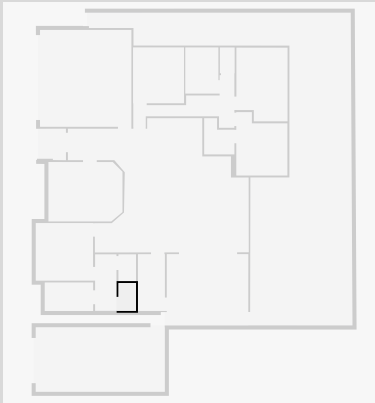

Bathroom

Width: 1.32 m
 Length: 3.50 m
 Area: 4.63 m²
 Perimeter: 9.65 m

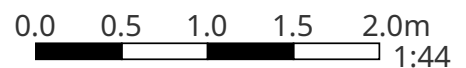
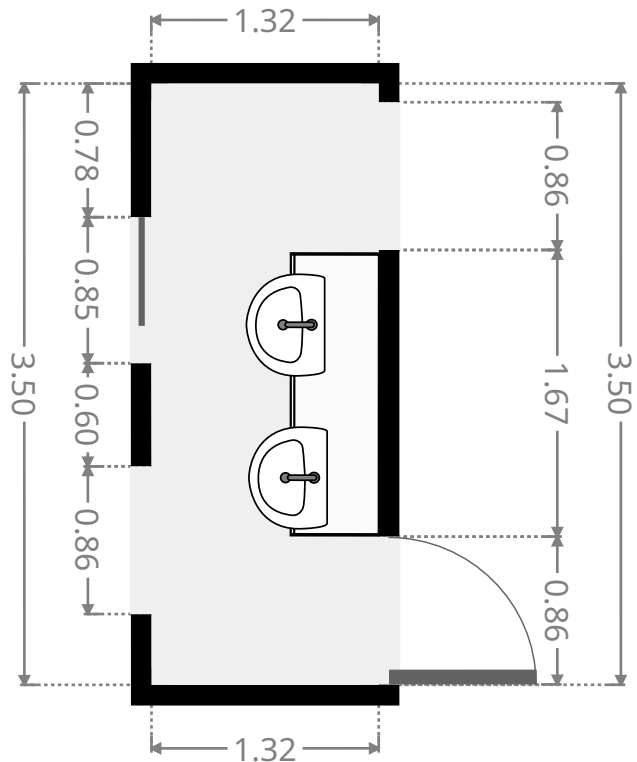

26 Govind Court

Master Bedroom

Width: 3.55 m
Length: 3.57 m
Area: 12.66 m²
Perimeter: 14.23 m

