

# 25A Main Street

Created on  
2021-02-18

Floors  
2

▼ Ground Floor

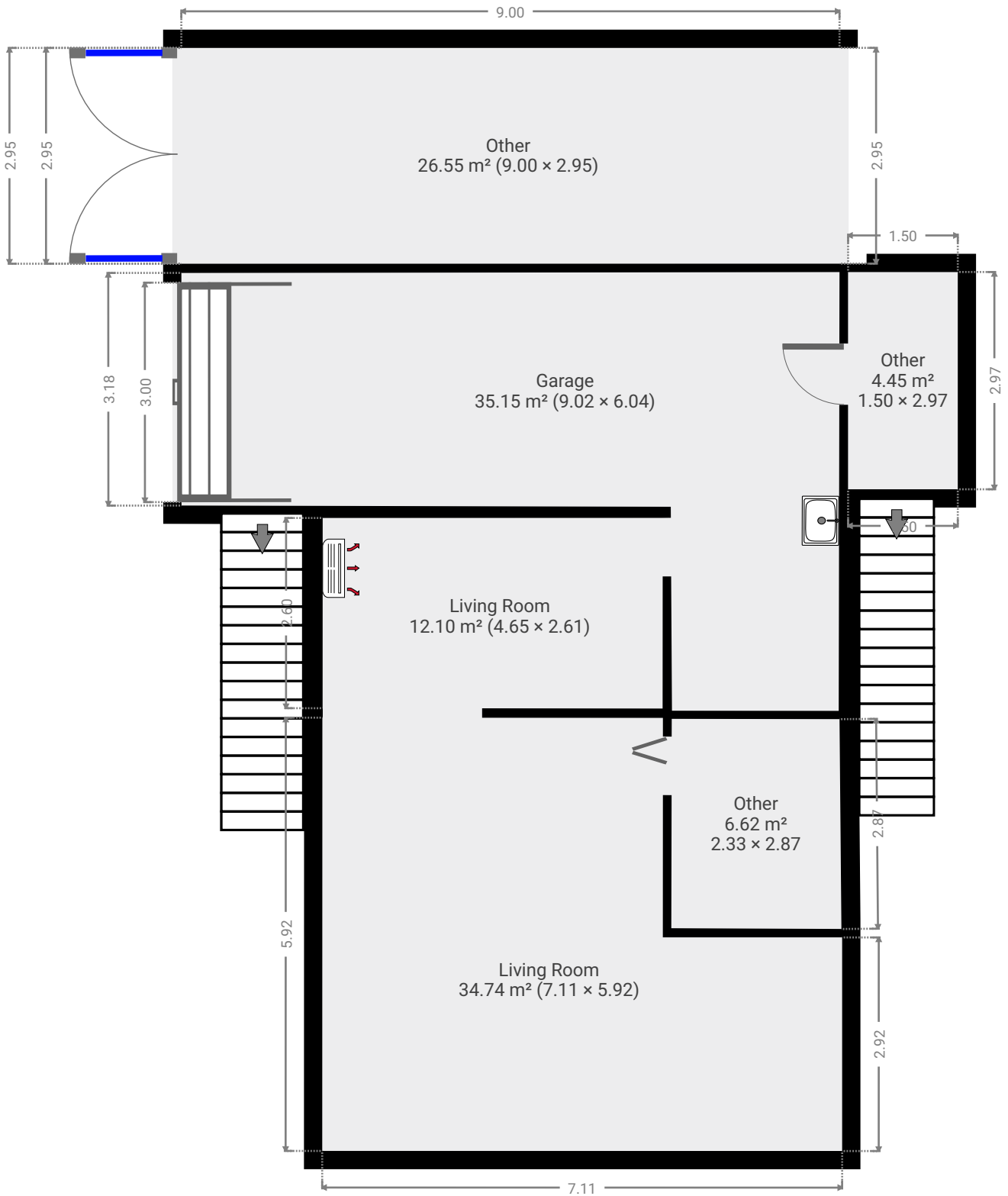

▼ **Garage**  
Ground Floor

WIDTH: 6.06 m • LENGTH: 9.02 m  
AREA: 35.15 m<sup>2</sup> • PERIMETER: 29.94 m

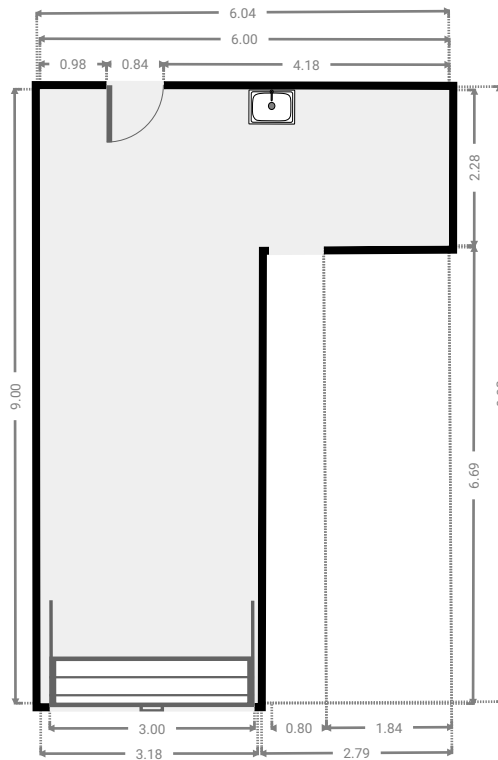
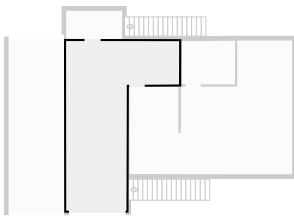

▼ **Living Room**  
Ground Floor

WIDTH: 2.61 m • LENGTH: 4.65 m  
AREA: 12.10 m<sup>2</sup> • PERIMETER: 14.51 m

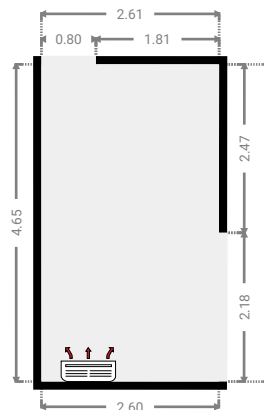
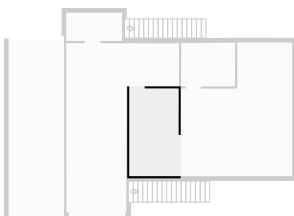

▼ Living Room  
Ground Floor

WIDTH: 5.92 m • LENGTH: 7.11 m  
AREA: 34.74 m<sup>2</sup> • PERIMETER: 26.06 m

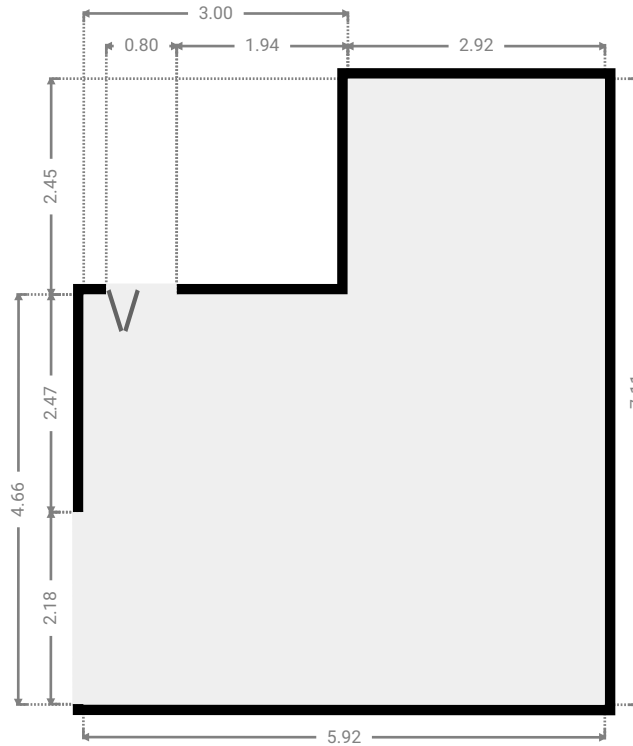
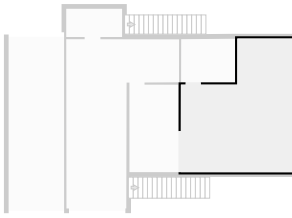

▼ Other  
Ground Floor

WIDTH: 2.87 m • LENGTH: 2.33 m  
AREA: 6.62 m<sup>2</sup> • PERIMETER: 10.35 m

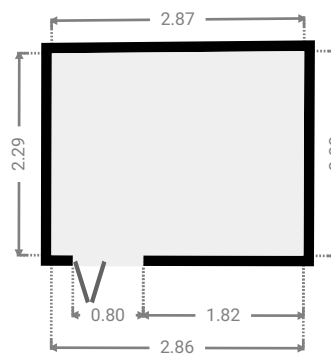
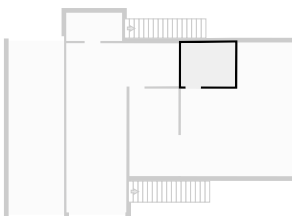

▼ Other  
Ground Floor

WIDTH: 2.97 m • LENGTH: 1.50 m  
AREA: 4.45 m<sup>2</sup> • PERIMETER: 8.94 m

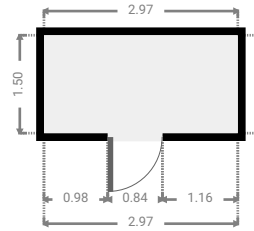
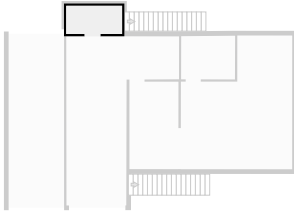

▼ Other  
Ground Floor

WIDTH: 2.95 m • LENGTH: 9.00 m  
AREA: 26.55 m<sup>2</sup> • PERIMETER: 23.90 m

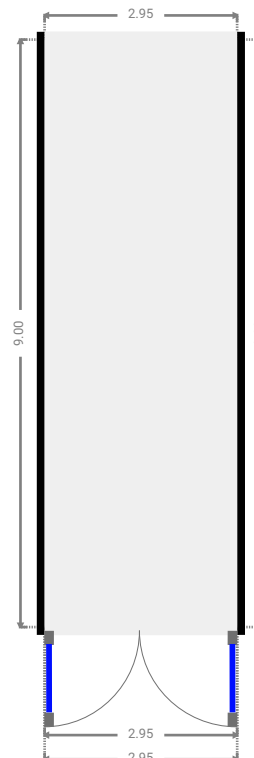
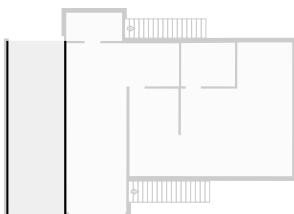

▼ 1st Floor

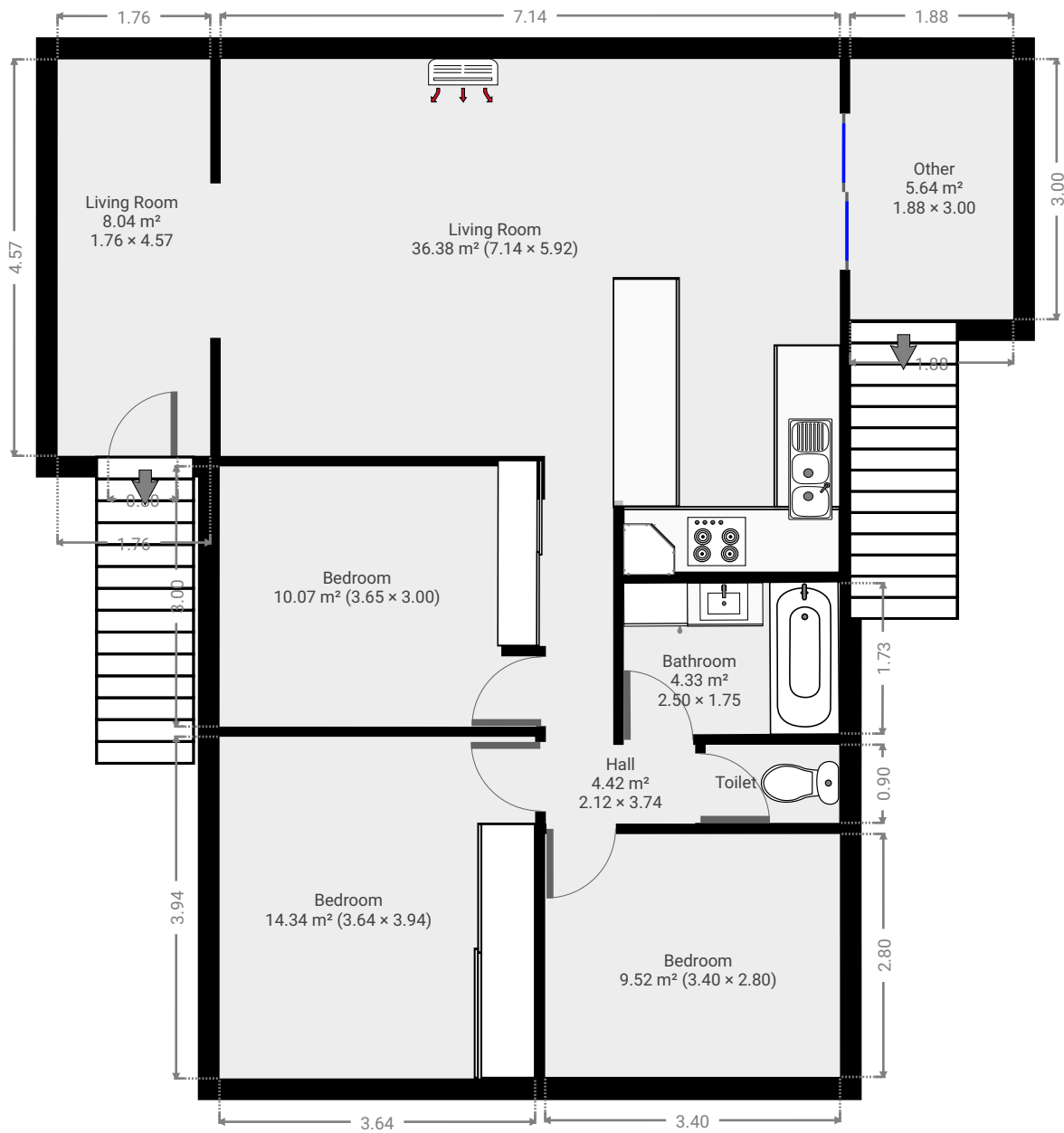

▼ Living Room  
1st Floor

WIDTH: 4.57 m • LENGTH: 1.76 m  
AREA: 8.04 m<sup>2</sup> • PERIMETER: 12.66 m

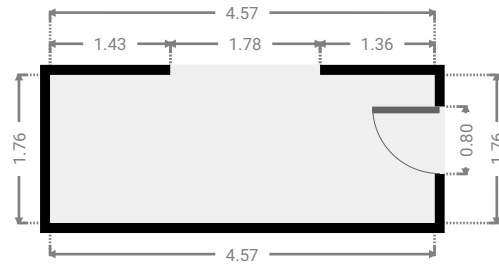
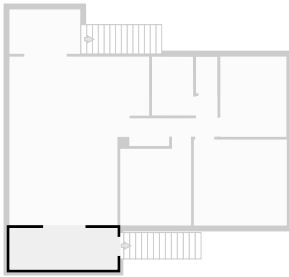

▼ Living Room  
1st Floor

WIDTH: 5.92 m • LENGTH: 7.14 m  
AREA: 36.38 m<sup>2</sup> • PERIMETER: 26.12 m

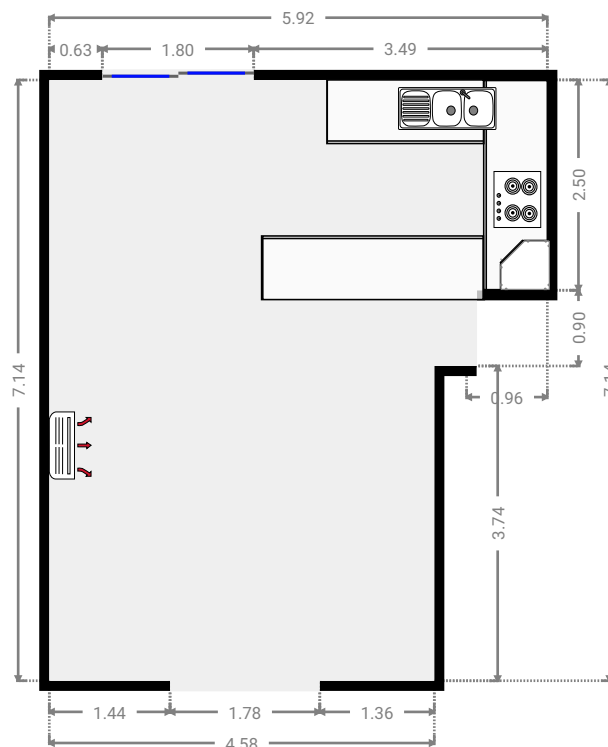
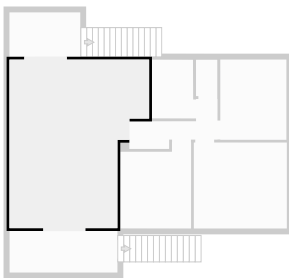

▼ Hall  
1st Floor

WIDTH: 3.74 m • LENGTH: 2.12 m  
AREA: 4.42 m<sup>2</sup> • PERIMETER: 11.70 m

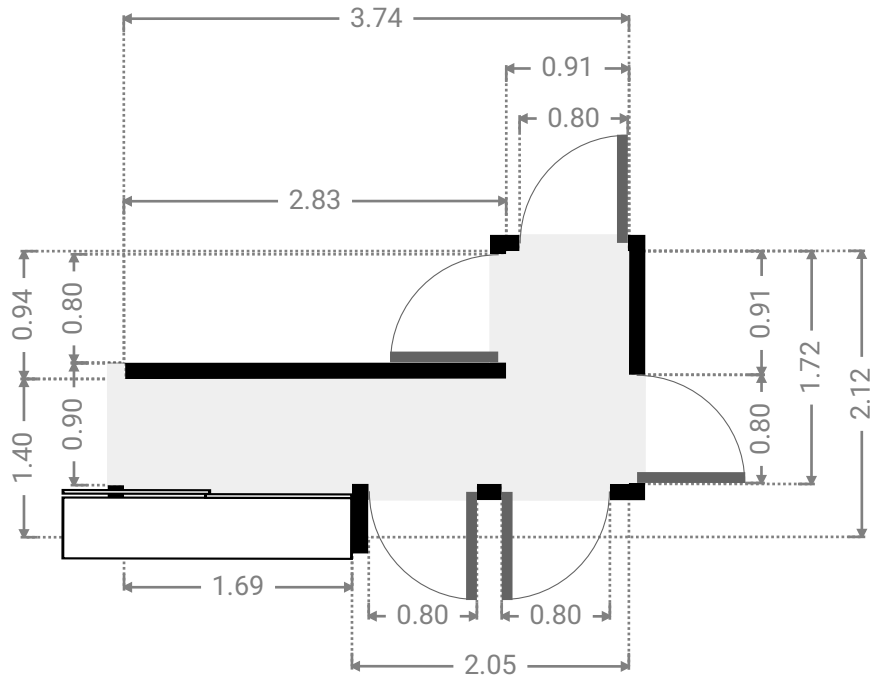
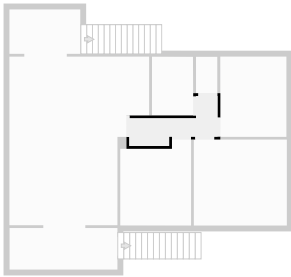

▼ Bedroom  
1st Floor

WIDTH: 3.00 m • LENGTH: 3.65 m  
AREA: 10.07 m<sup>2</sup> • PERIMETER: 13.30 m

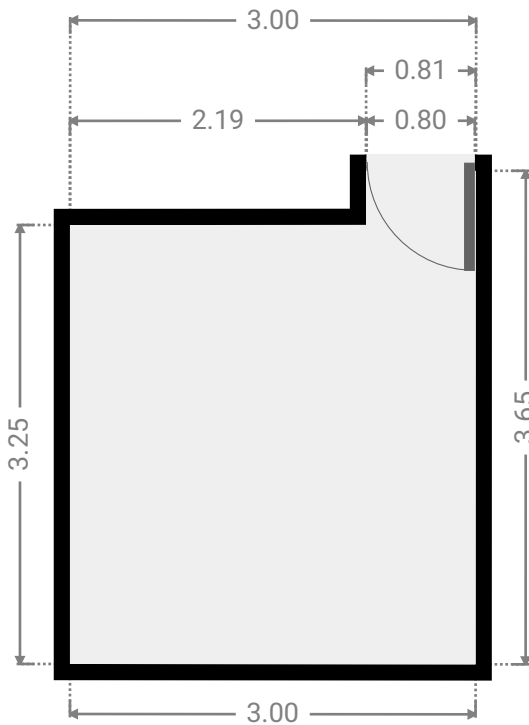
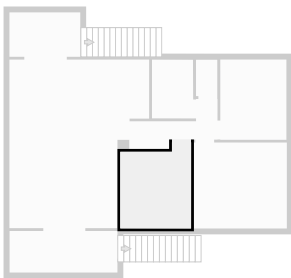



▼ **Bedroom**  
1st Floor

WIDTH: 3.94 m • LENGTH: 3.64 m  
AREA: 14.34 m<sup>2</sup> • PERIMETER: 15.16 m

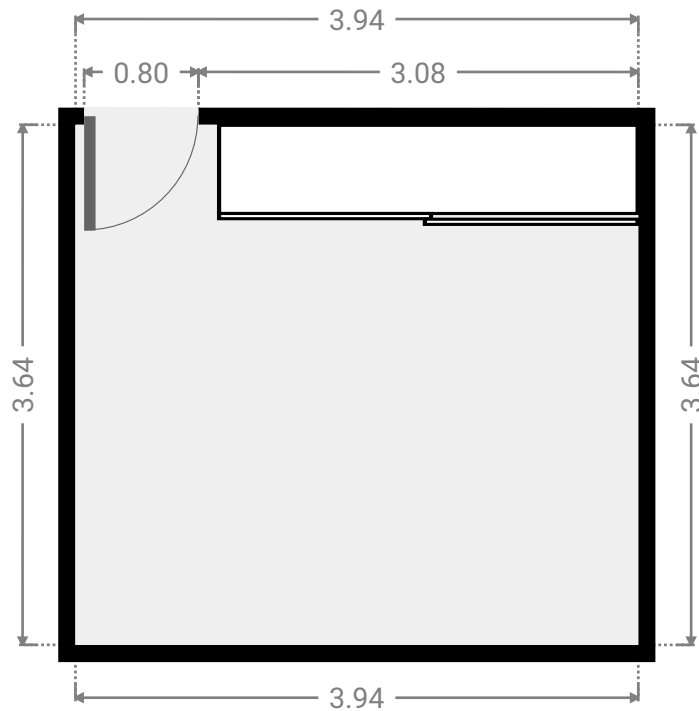
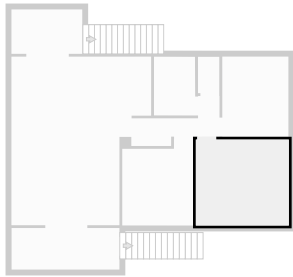

▼ **Bedroom**  
1st Floor

WIDTH: 2.80 m • LENGTH: 3.40 m  
AREA: 9.52 m<sup>2</sup> • PERIMETER: 12.40 m

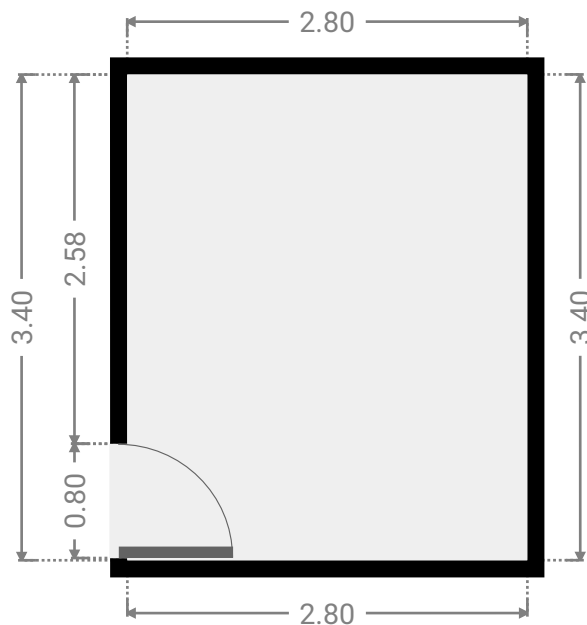
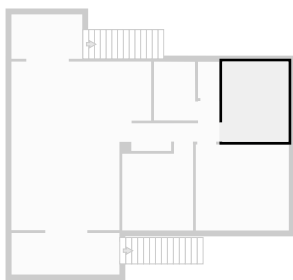



▼ Other  
1st Floor

WIDTH: 3.00 m • LENGTH: 1.88 m  
AREA: 5.64 m<sup>2</sup> • PERIMETER: 9.76 m

