

258 Agnes Street

Ground Floor

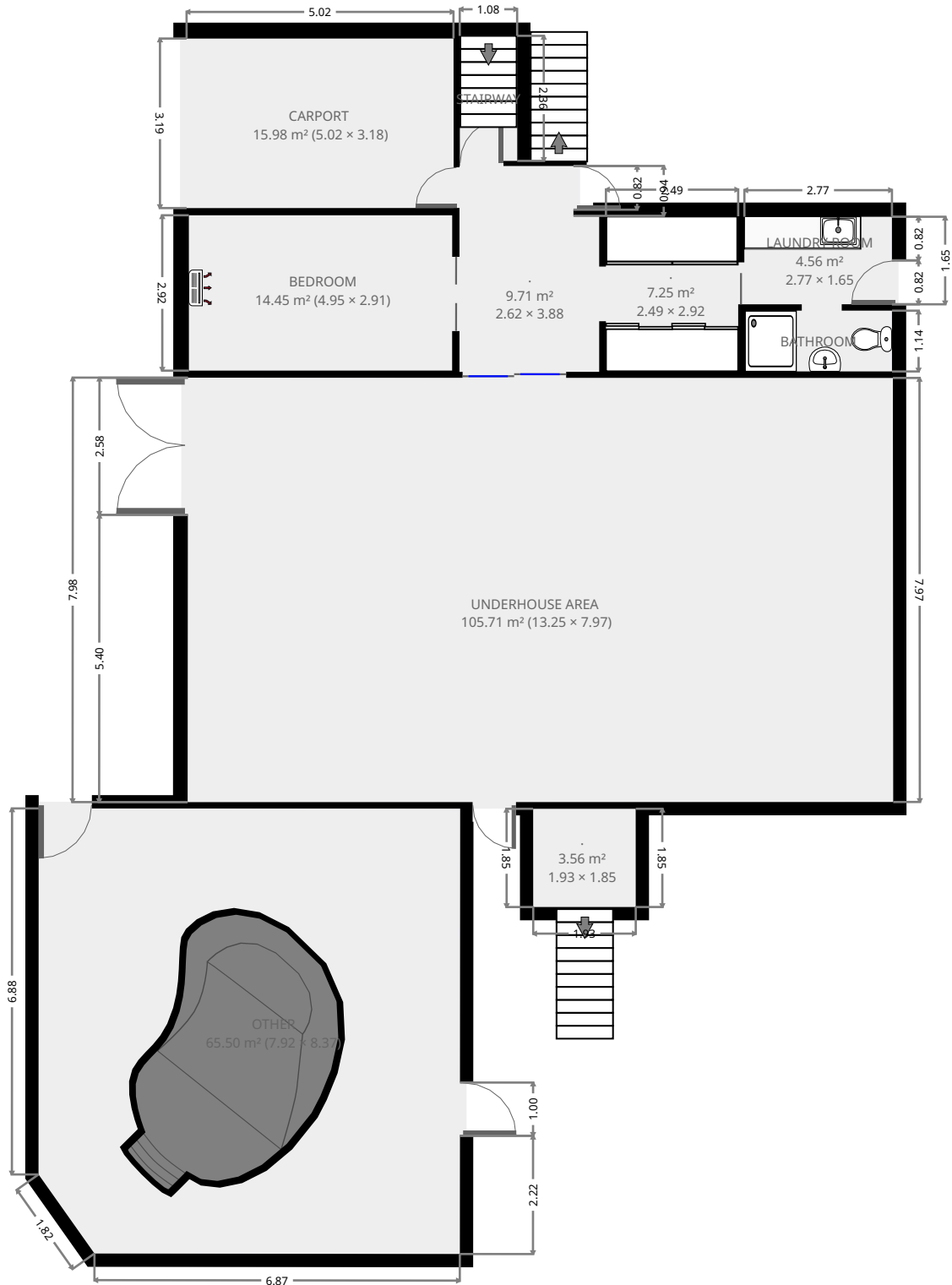

THIS FLOORPLAN IS PROVIDED WITHOUT WARRANTY OF ANY KIND. SENSOPIA DISCLAIMS ANY WARRANTY INCLUDING, WITHOUT LIMITATION, SATISFACTORY QUALITY OR ACCURACY OF DIMENSIONS.



258 Agnes Street

Width: 2.62 m
 Length: 3.88 m
 Area: 9.71 m²
 Perimeter: 12.99 m

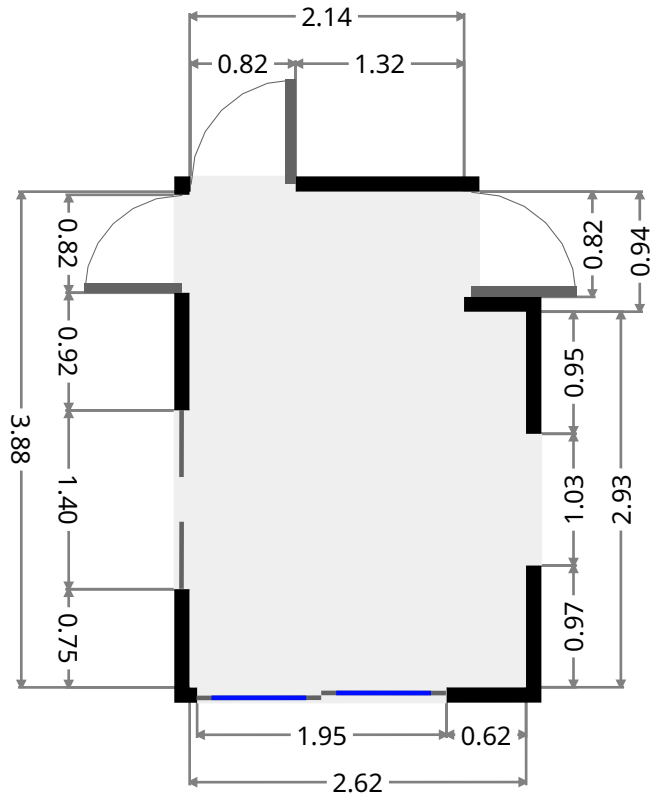
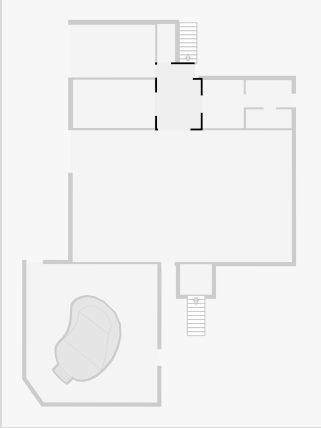

Bedroom

Width: 2.91 m
 Length: 4.95 m
 Area: 14.45 m²
 Perimeter: 15.74 m

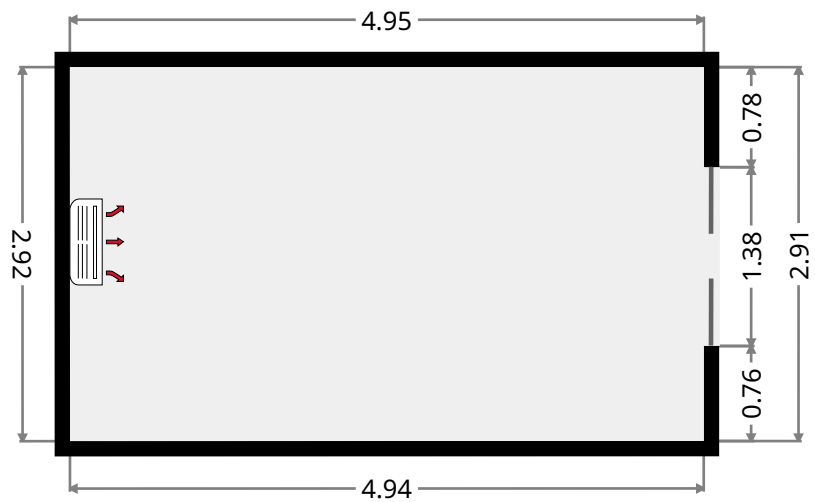
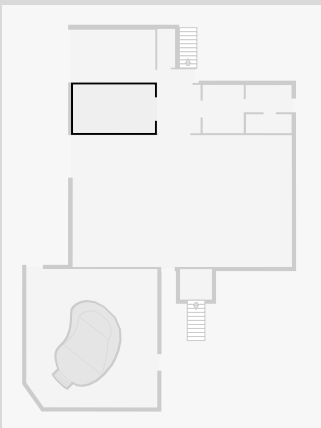

THIS FLOORPLAN IS PROVIDED WITHOUT WARRANTY OF ANY KIND. SENSOPIA DISCLAIMS ANY WARRANTY INCLUDING, WITHOUT LIMITATION, SATISFACTORY QUALITY OR ACCURACY OF DIMENSIONS.

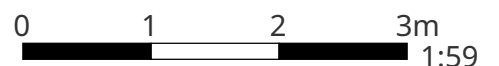

258 Agnes Street

•
 Width: 2.49 m
 Length: 2.92 m
 Area: 7.25 m²
 Perimeter: 10.80 m

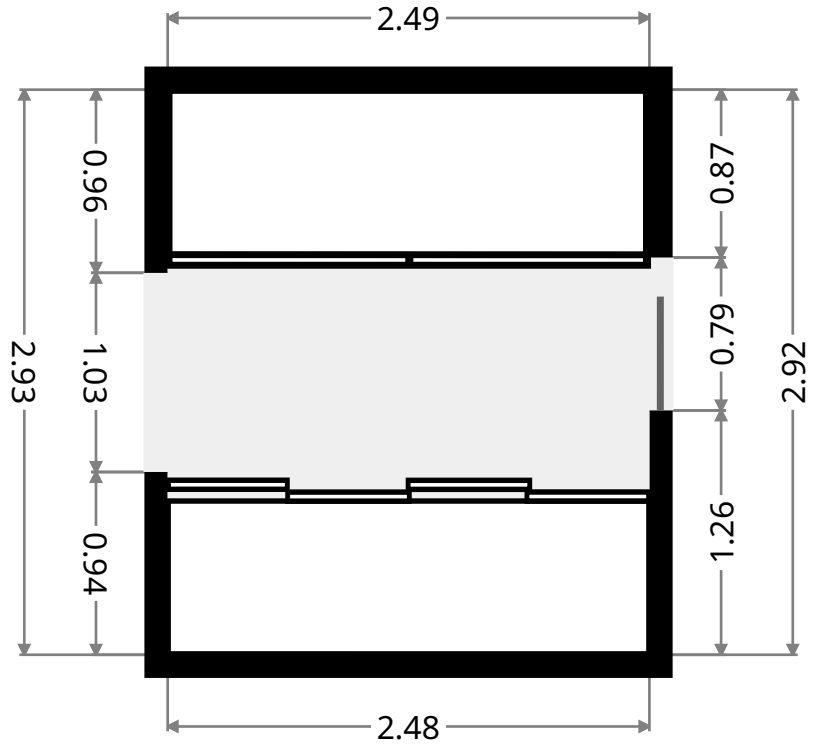
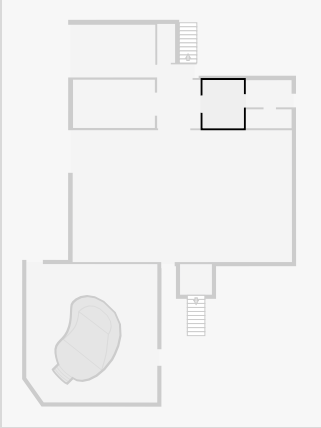

Laundry Room

Width: 1.65 m
 Length: 2.77 m
 Area: 4.56 m²
 Perimeter: 8.84 m

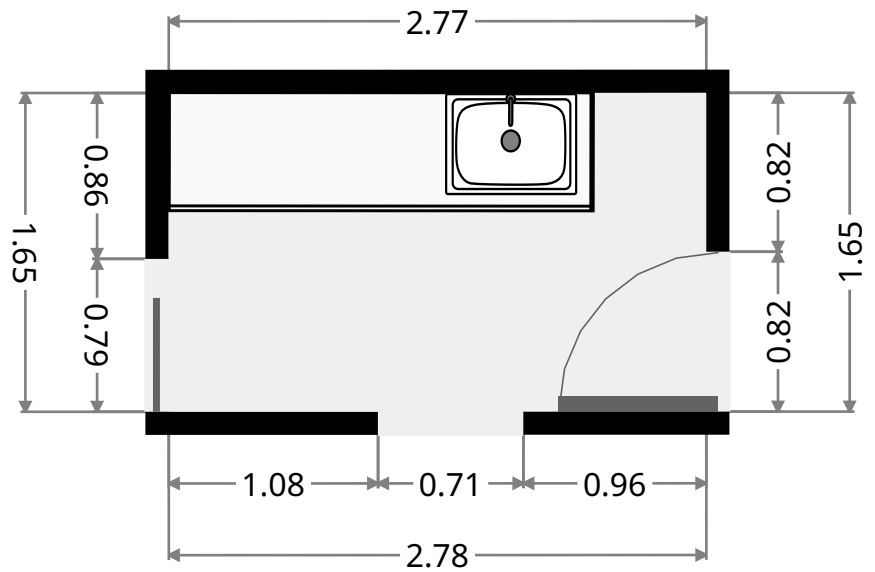
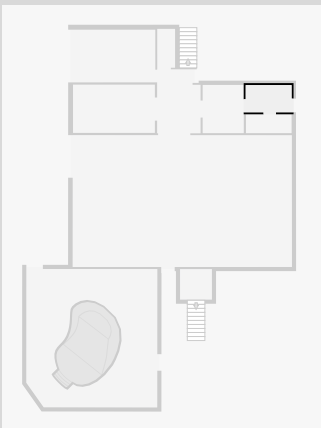

258 Agnes Street

Bathroom

Width: 1.14 m
Length: 2.76 m
Area: 3.15 m²
Perimeter: 7.80 m

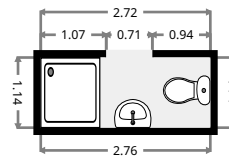
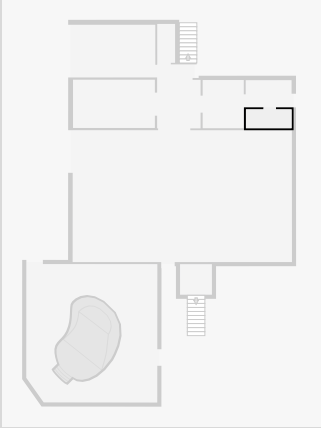

Underhouse Area

Width: 7.97 m
Length: 13.25 m
Area: 105.71 m²
Perimeter: 42.46 m

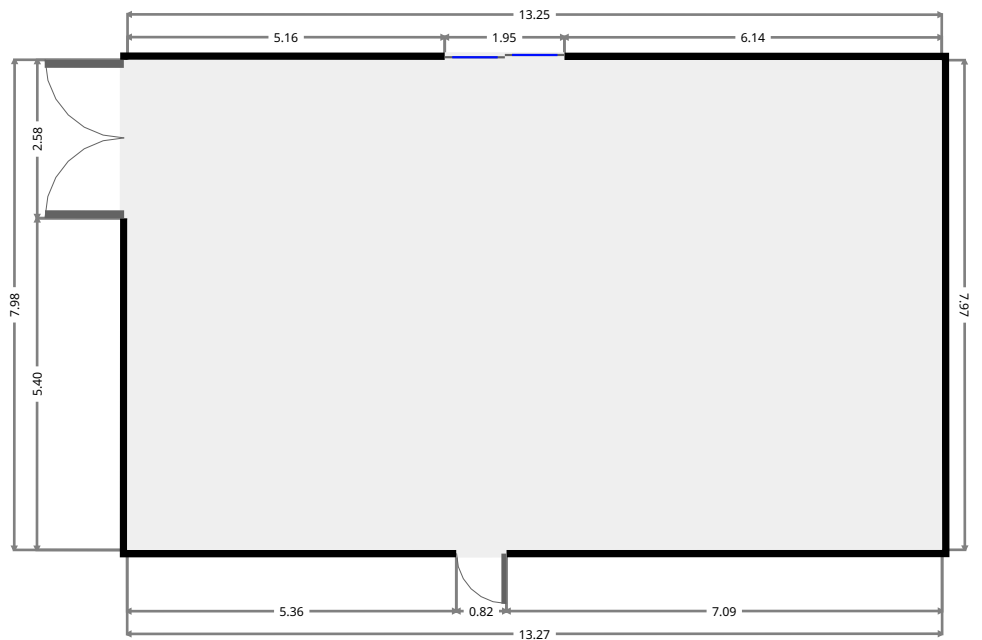
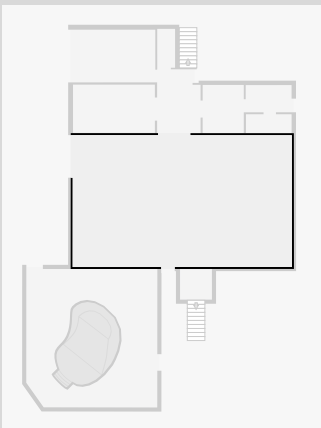

258 Agnes Street

•
Width: 1.85 m
Length: 1.93 m
Area: 3.56 m²
Perimeter: 7.55 m

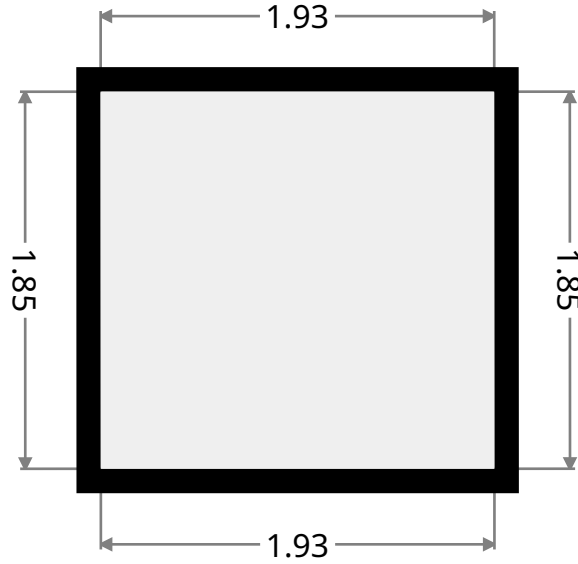
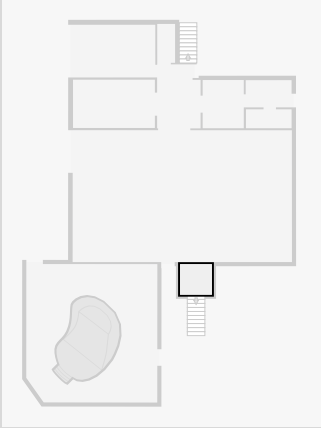

Stairway

Width: 1.08 m
Length: 2.36 m
Area: 2.53 m²
Perimeter: 6.86 m

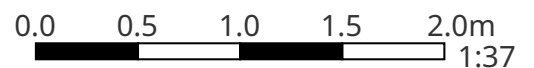
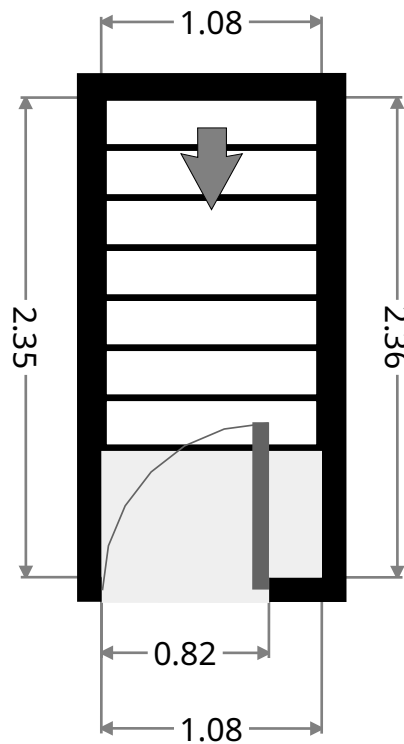
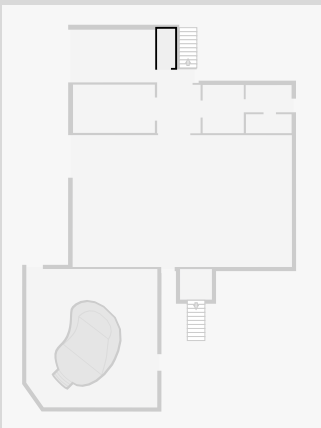

258 Agnes Street

Carport

Width: 3.18 m
 Length: 5.02 m
 Area: 15.98 m²
 Perimeter: 16.41 m

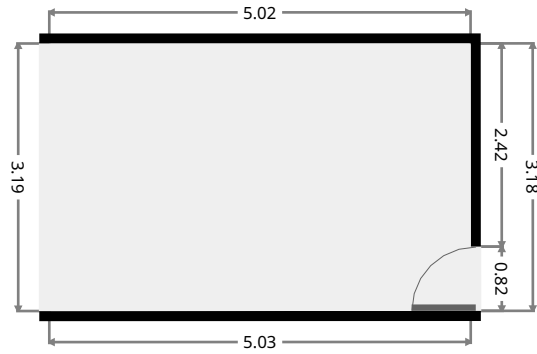
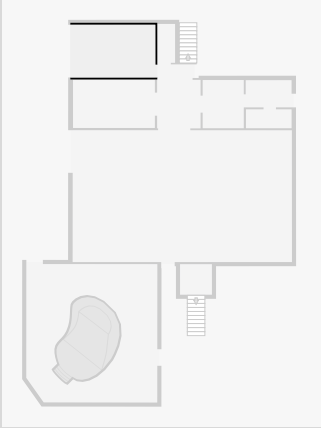

Other

Width: 7.92 m
 Length: 8.37 m
 Area: 65.50 m²
 Perimeter: 31.86 m
 Ceiling Height: 2.17 m

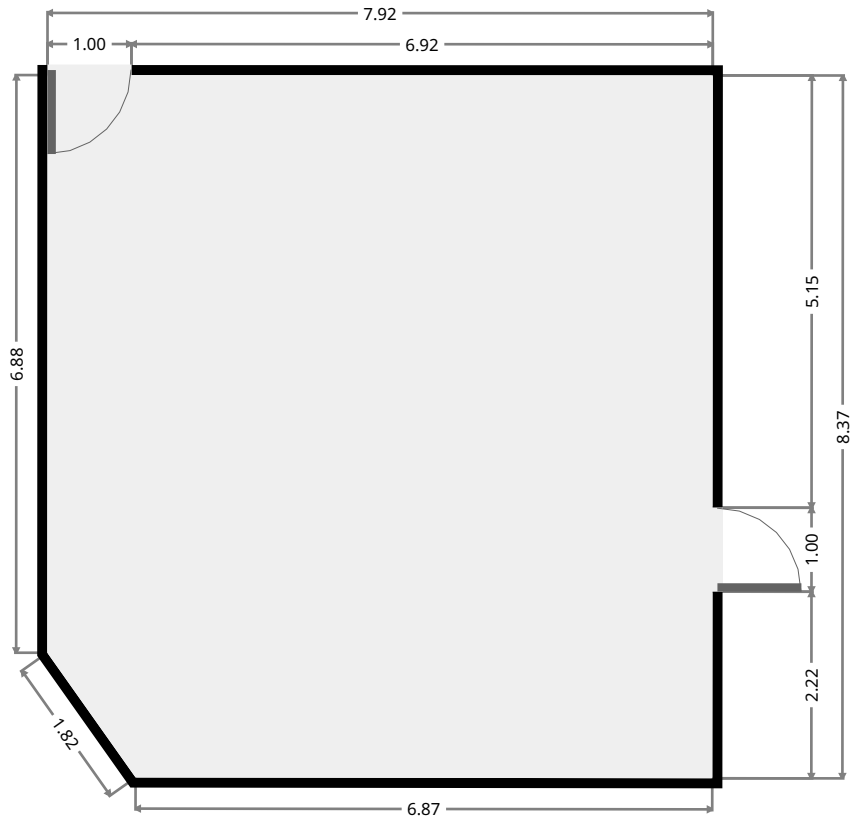
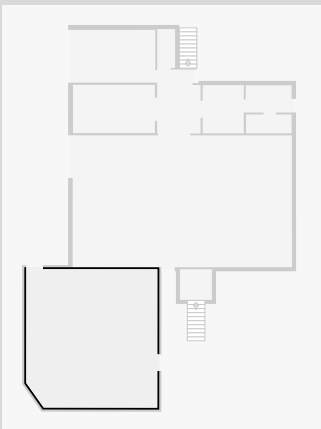

THIS FLOORPLAN IS PROVIDED WITHOUT WARRANTY OF ANY KIND. SENSOPIA DISCLAIMS ANY WARRANTY INCLUDING, WITHOUT LIMITATION, SATISFACTORY QUALITY OR ACCURACY OF DIMENSIONS.

258 Agnes Street

1st Floor

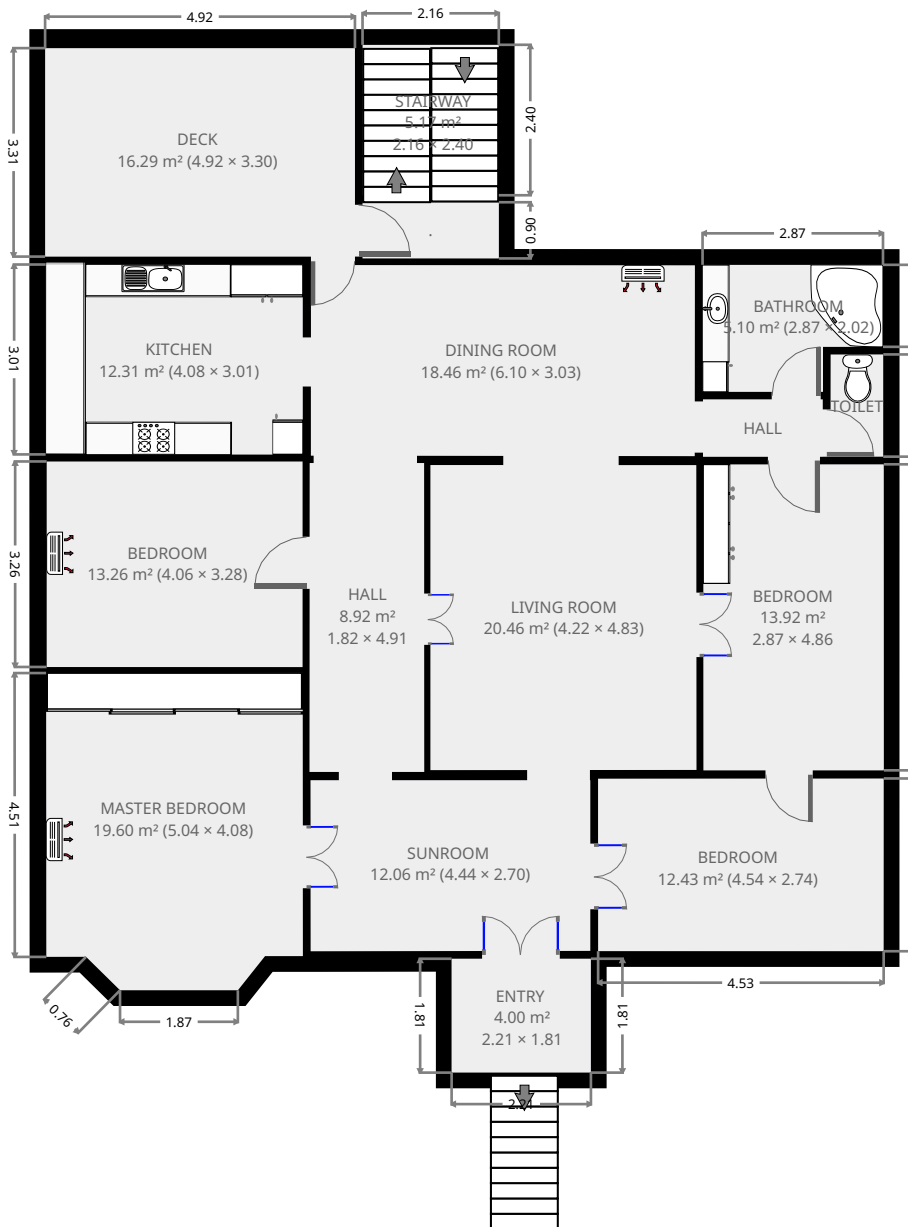

THIS FLOORPLAN IS PROVIDED WITHOUT WARRANTY OF ANY KIND. SENSOPIA DISCLAIMS ANY WARRANTY INCLUDING, WITHOUT LIMITATION, SATISFACTORY QUALITY OR ACCURACY OF DIMENSIONS.



258 Agnes Street

Sunroom

Width: 2.70 m
 Length: 4.44 m
 Area: 12.06 m²
 Perimeter: 14.31 m

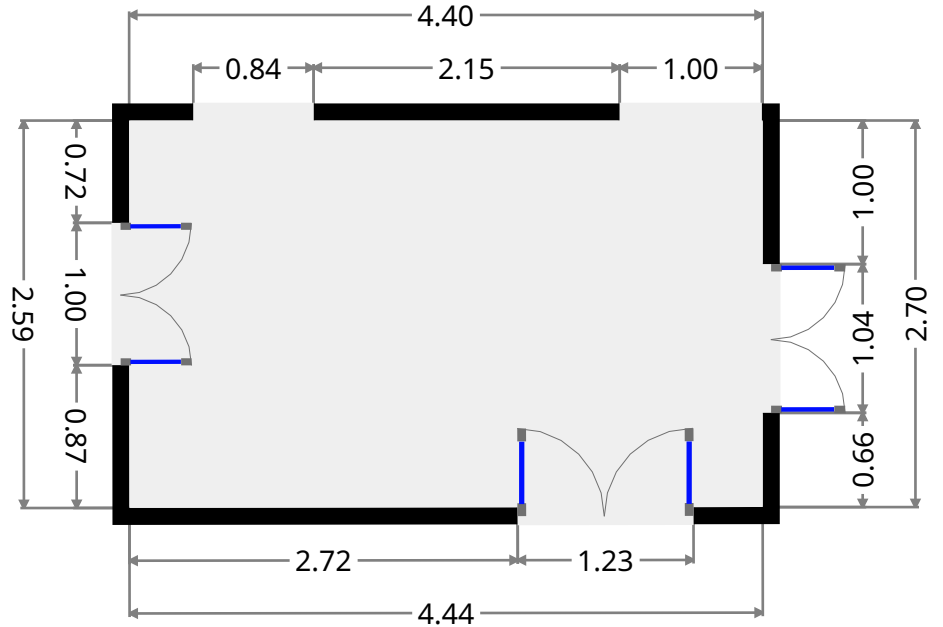
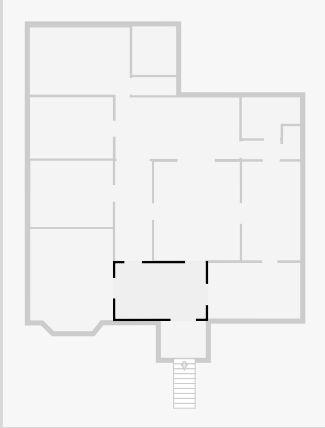

Bedroom

Width: 2.74 m
 Length: 4.54 m
 Area: 12.43 m²
 Perimeter: 14.55 m

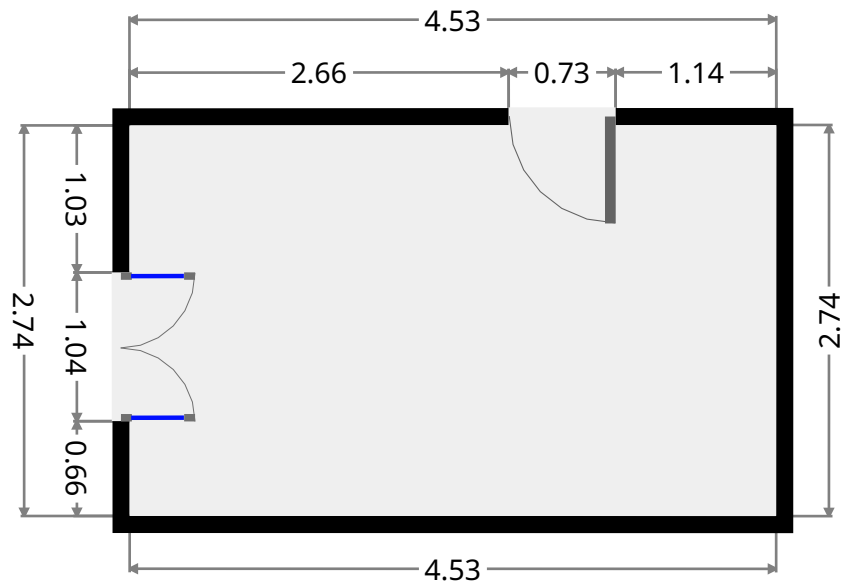
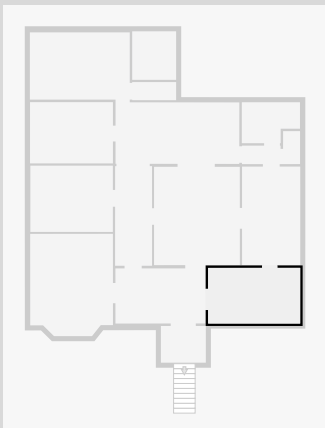

258 Agnes Street

Master Bedroom

Width: 4.08 m
 Length: 5.04 m
 Area: 19.60 m²
 Perimeter: 17.63 m
 Ceiling Height: 2.17 m

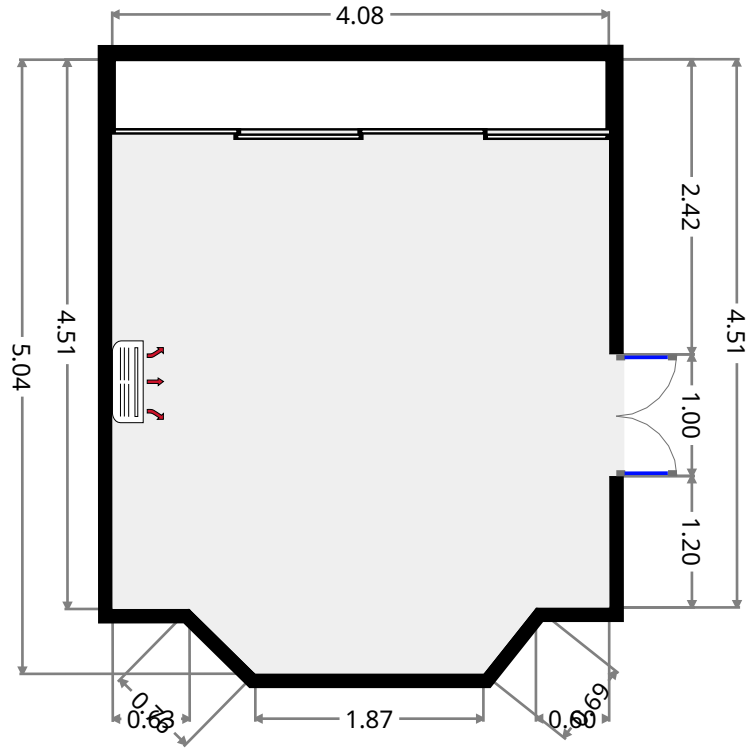
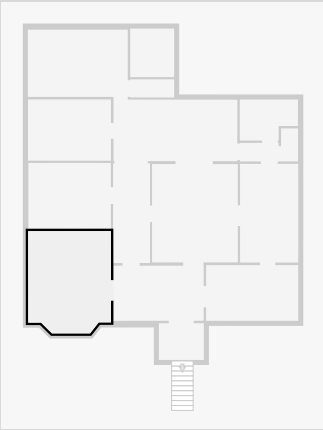

Hall

Width: 1.82 m
 Length: 4.91 m
 Area: 8.92 m²
 Perimeter: 13.45 m

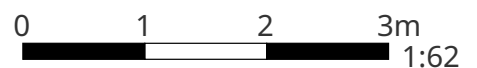
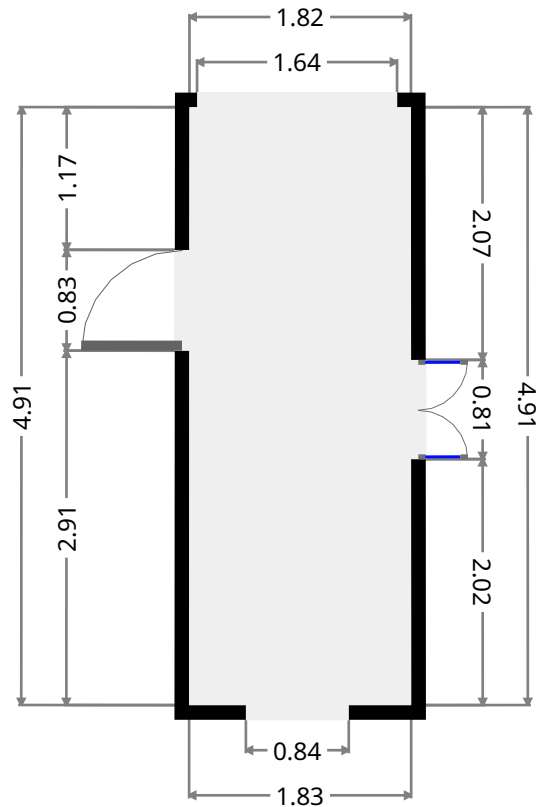
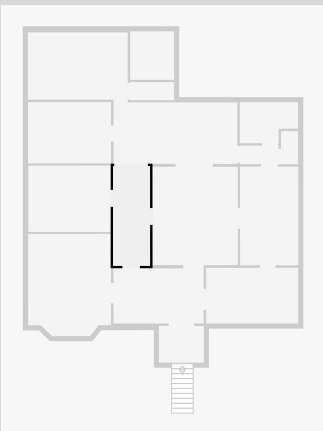

THIS FLOORPLAN IS PROVIDED WITHOUT WARRANTY OF ANY KIND. SENSOPIA DISCLAIMS ANY WARRANTY INCLUDING, WITHOUT LIMITATION, SATISFACTORY QUALITY OR ACCURACY OF DIMENSIONS.

258 Agnes Street

Bedroom

Width: 3.28 m
 Length: 4.06 m
 Area: 13.26 m²
 Perimeter: 14.65 m

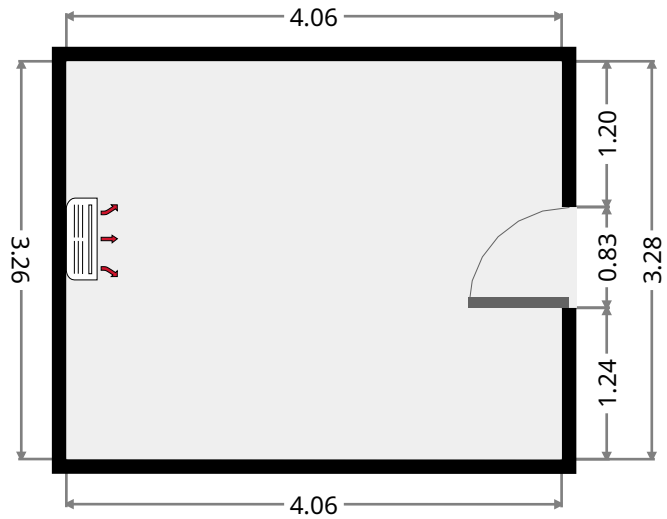
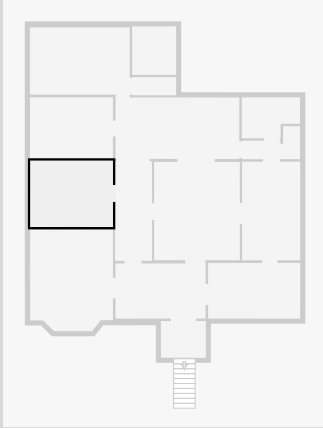

Living Room

Width: 4.22 m
 Length: 4.83 m
 Area: 20.46 m²
 Perimeter: 18.13 m

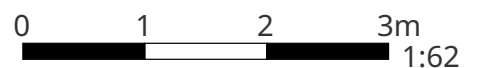
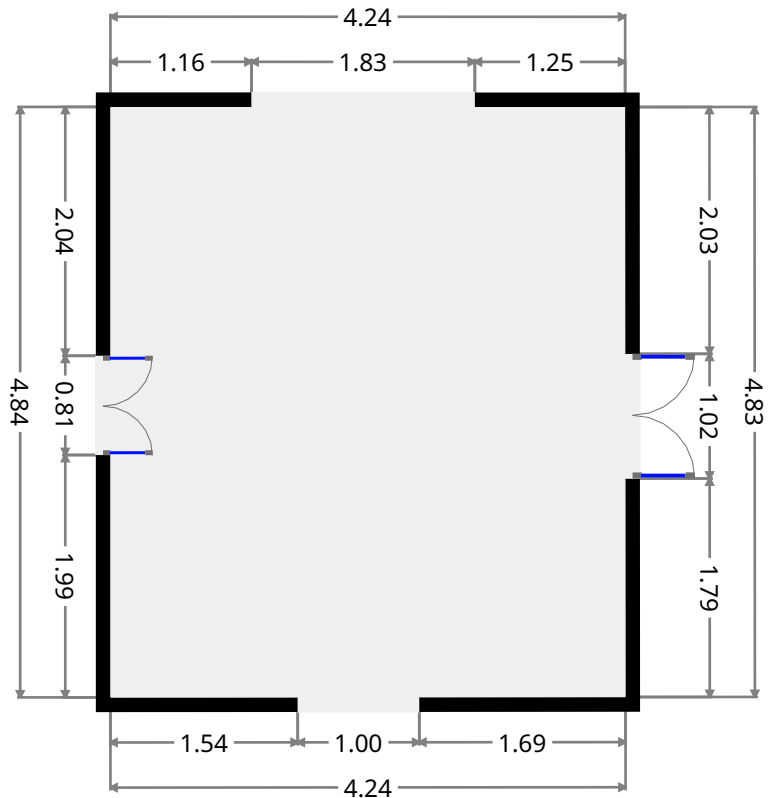
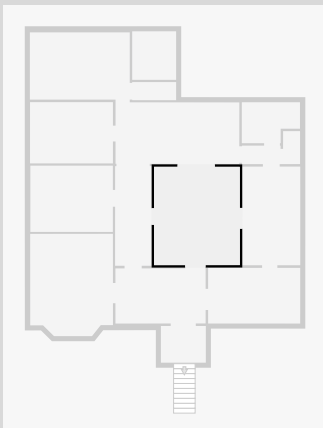

THIS FLOORPLAN IS PROVIDED WITHOUT WARRANTY OF ANY KIND. SENSOPIA DISCLAIMS ANY WARRANTY INCLUDING, WITHOUT LIMITATION, SATISFACTORY QUALITY OR ACCURACY OF DIMENSIONS.

258 Agnes Street

Bedroom

Width: 2.87 m
 Length: 4.86 m
 Area: 13.92 m²
 Perimeter: 15.45 m

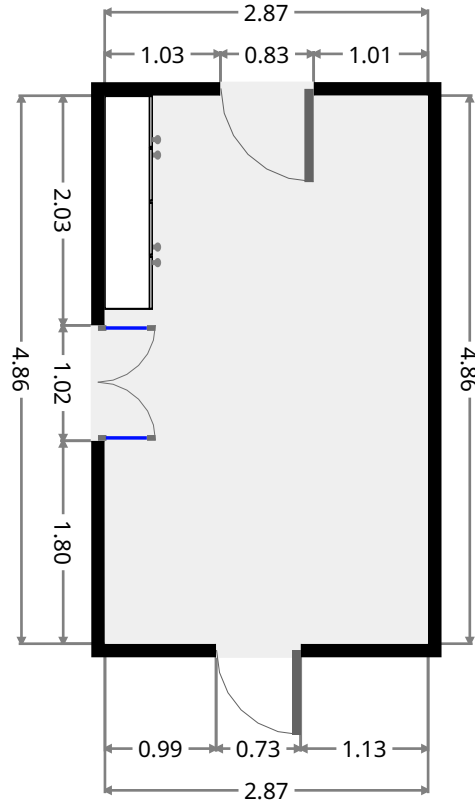
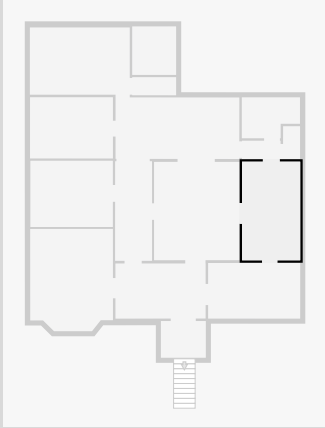

Dining Room

Width: 3.03 m
 Length: 6.10 m
 Area: 18.46 m²
 Perimeter: 18.25 m

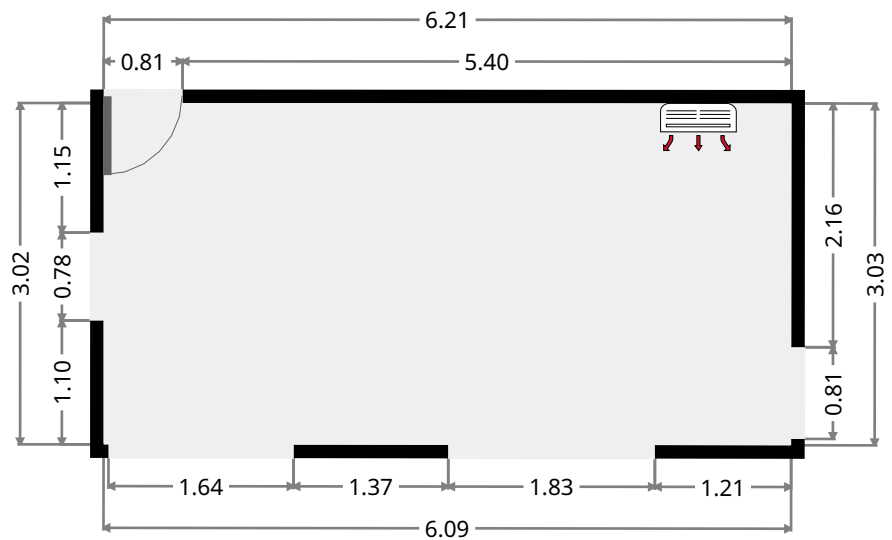
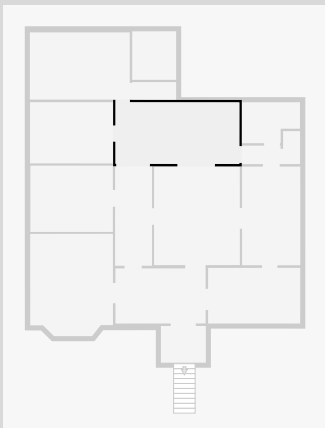

258 Agnes Street

Hall

Width: 0.91 m
 Length: 1.90 m
 Area: 1.73 m²
 Perimeter: 5.63 m

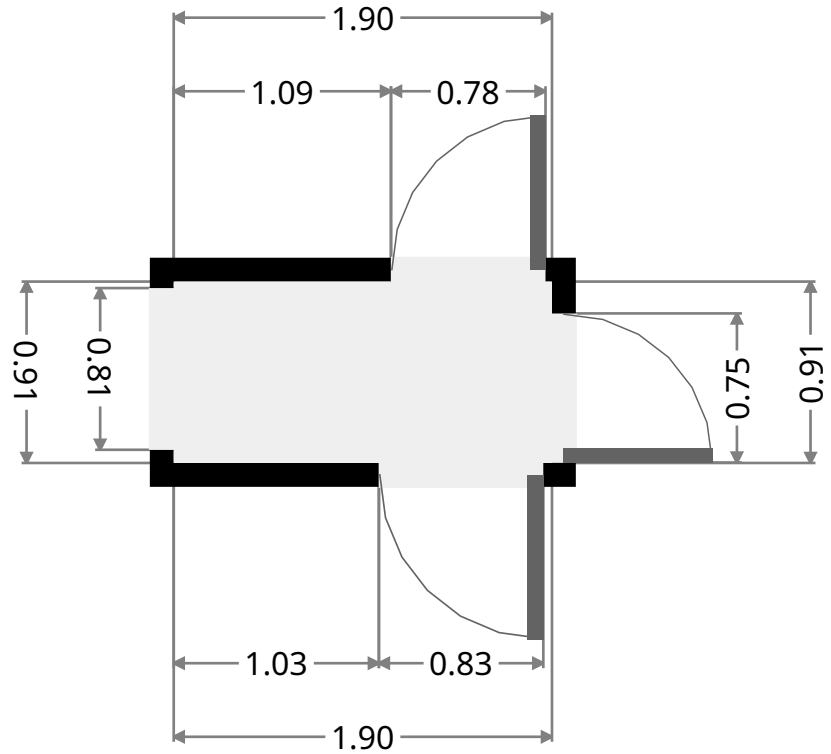
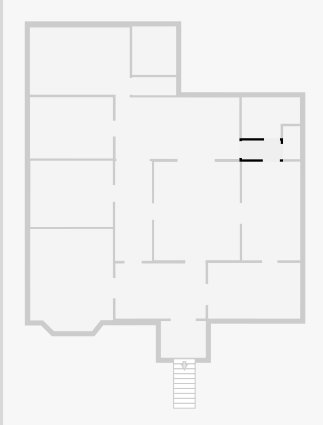

Bathroom

Width: 2.02 m
 Length: 2.87 m
 Area: 5.10 m²
 Perimeter: 9.76 m

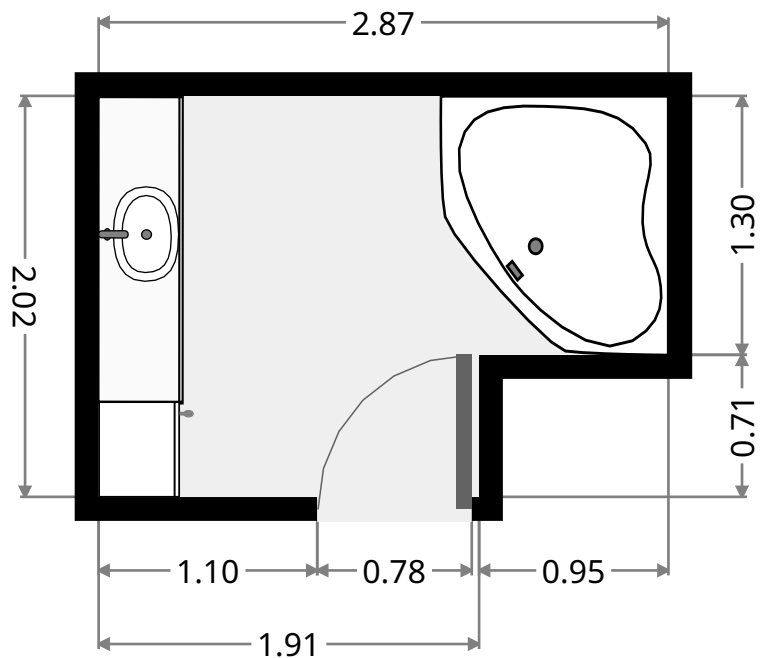
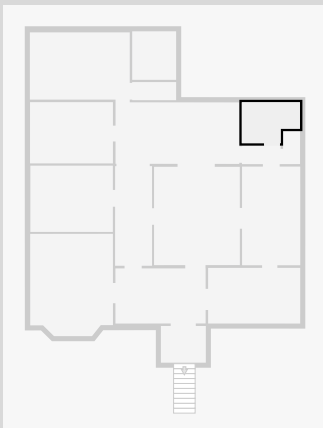

THIS FLOORPLAN IS PROVIDED WITHOUT WARRANTY OF ANY KIND. SENSOPIA DISCLAIMS ANY WARRANTY INCLUDING, WITHOUT LIMITATION, SATISFACTORY QUALITY OR ACCURACY OF DIMENSIONS.

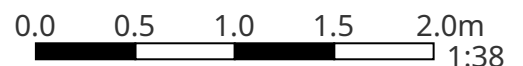

258 Agnes Street

Toilet

Width: 0.84 m
Length: 1.62 m
Area: 1.36 m²
Perimeter: 4.92 m

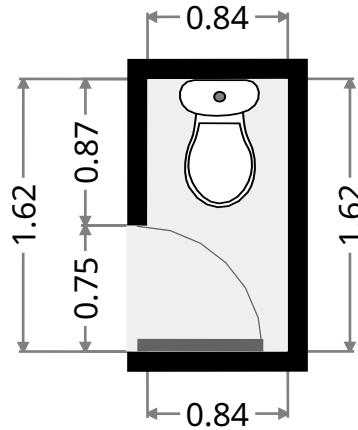
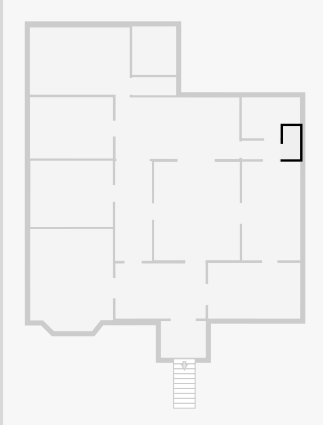

Kitchen

Width: 3.01 m
Length: 4.08 m
Area: 12.31 m²
Perimeter: 14.20 m

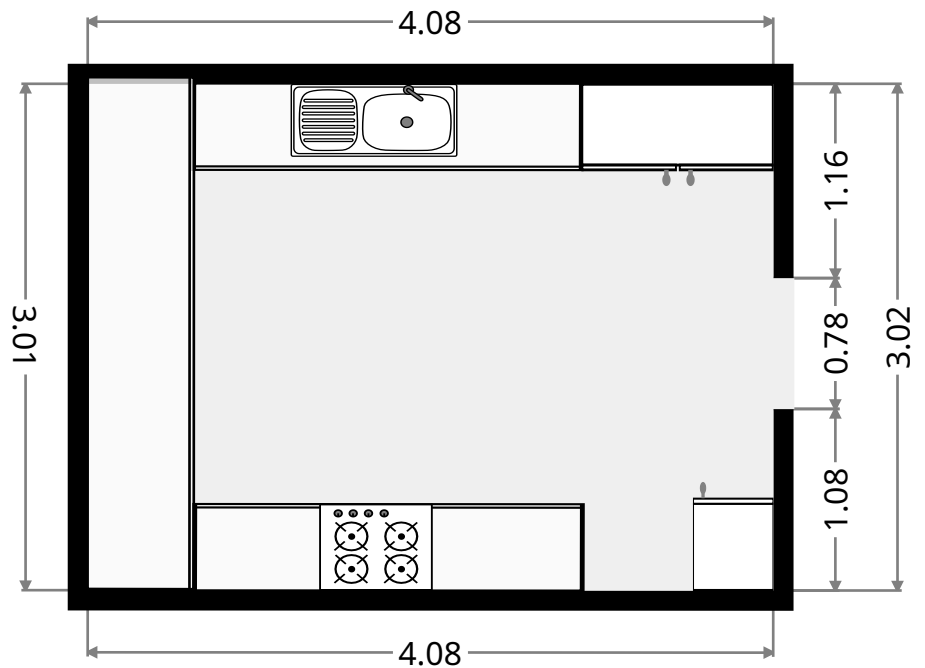
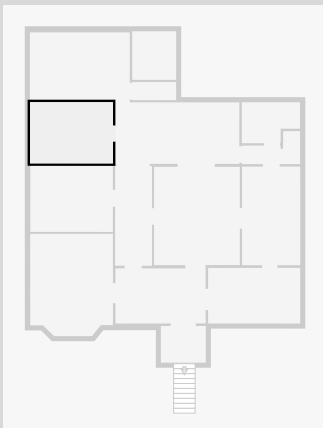

258 Agnes Street

Deck

Width: 3.30 m
 Length: 4.92 m
 Area: 16.29 m²
 Perimeter: 16.46 m

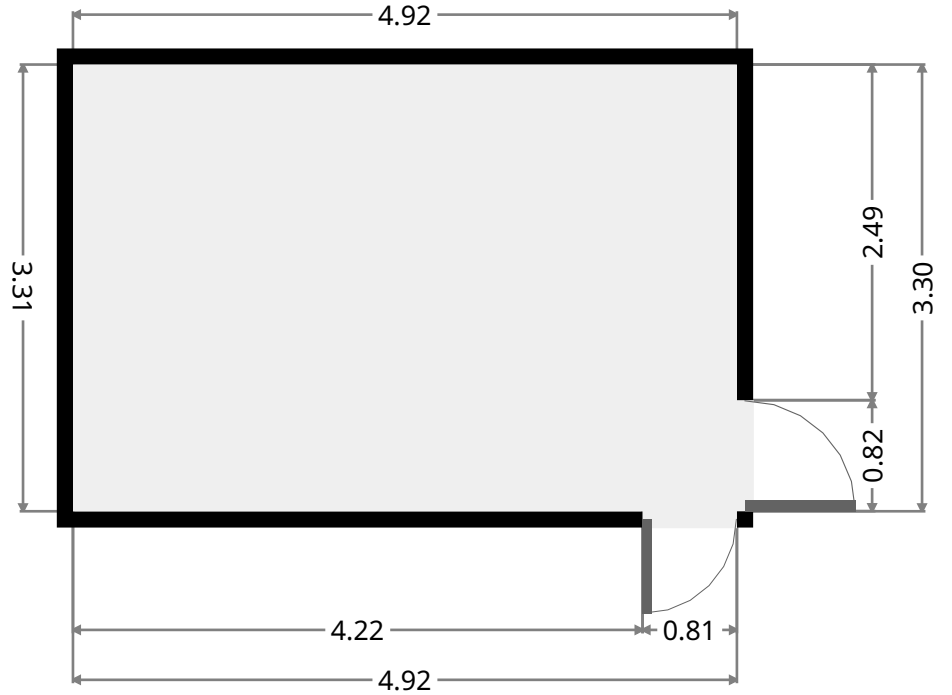
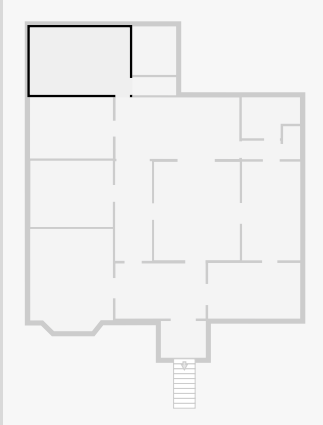

•
 Width: 0.90 m
 Length: 2.17 m
 Area: 1.93 m²
 Perimeter: 6.12 m

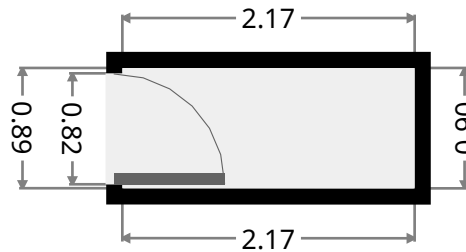
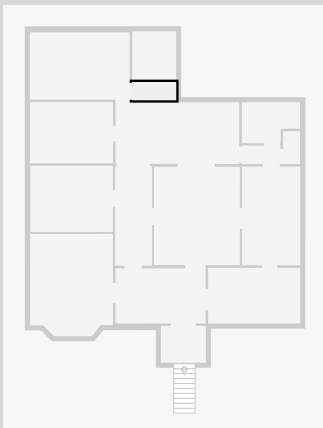

258 Agnes Street

Stairway

Width: 2.16 m
Length: 2.40 m
Area: 5.17 m²
Perimeter: 9.11 m

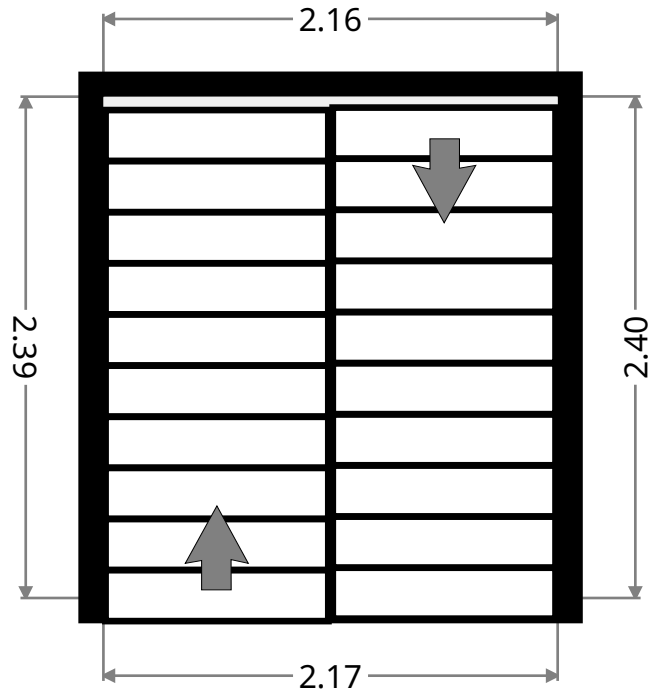
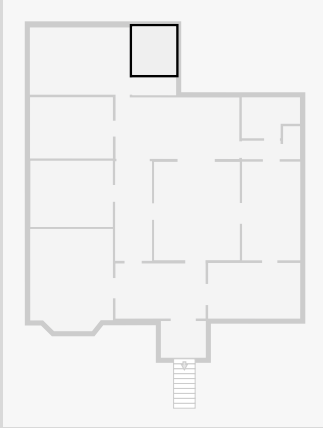

Entry

Width: 1.81 m
Length: 2.21 m
Area: 4.00 m²
Perimeter: 8.04 m

