

254 Clanfield Street

SUBMITTED BY
Janelle Casey

CREATED ON
2019-09-26

Floors
1

▼ Ground Floor



▼ **Hall**
Ground Floor

WIDTH: 1.32 m • LENGTH: 1.18 m
AREA: 1.56 m² • PERIMETER: 5.00 m

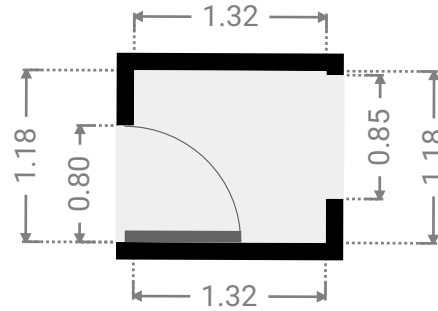
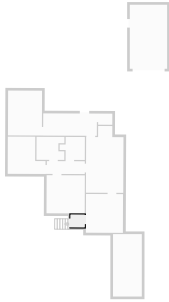

▼ **Living Room**
Ground Floor

WIDTH: 3.47 m • LENGTH: 3.63 m
AREA: 12.60 m² • PERIMETER: 14.20 m

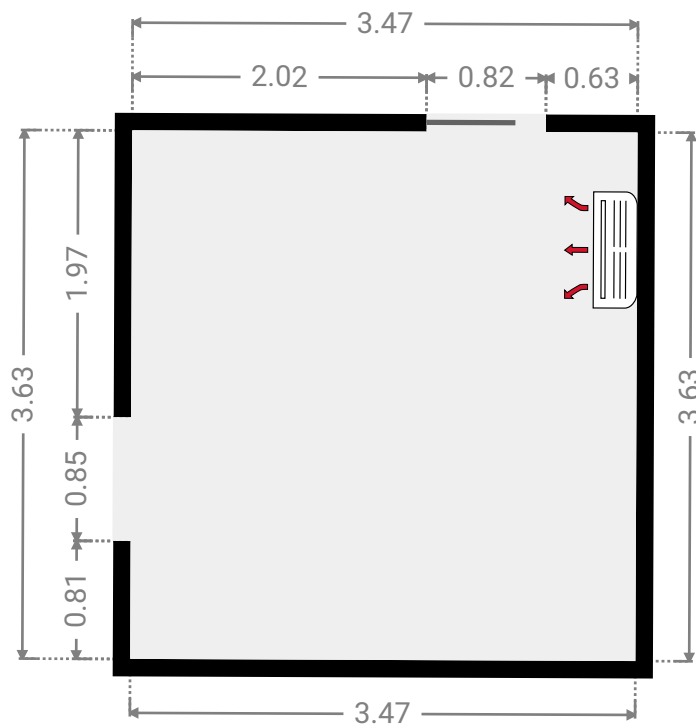
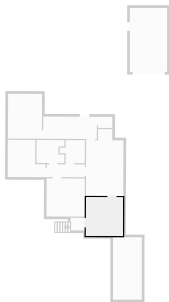

▼ **Kitchen**
Ground Floor

WIDTH: 3.50 m • LENGTH: 6.26 m
AREA: 19.65 m² • PERIMETER: 19.52 m

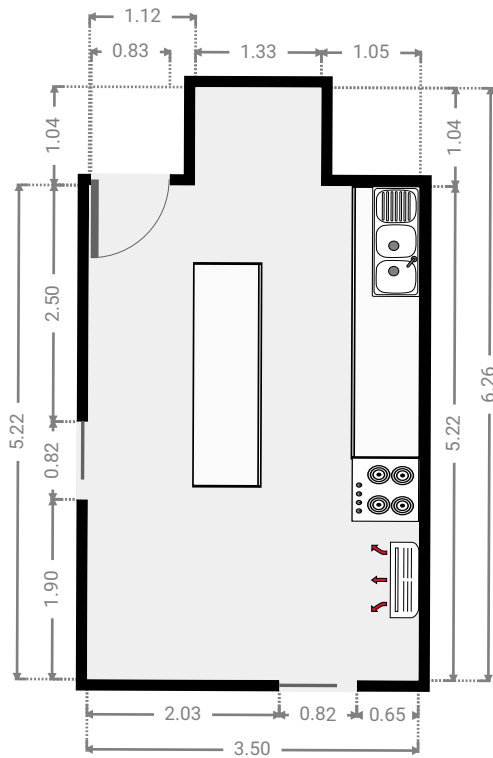
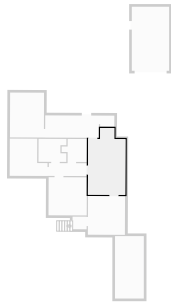

▼ **Hall**
Ground Floor

WIDTH: 3.56 m • LENGTH: 1.20 m
AREA: 4.27 m² • PERIMETER: 9.52 m

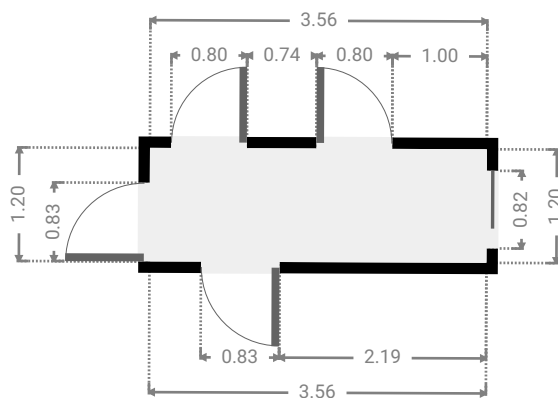
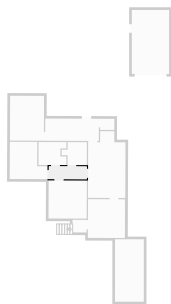

▼ **Bathroom**
Ground Floor

WIDTH: 2.36 m • LENGTH: 2.15 m
AREA: 4.17 m² • PERIMETER: 9.02 m

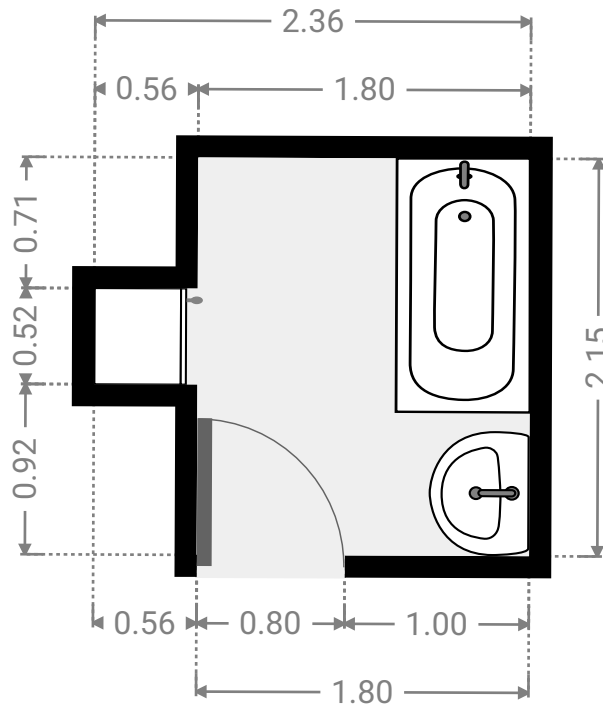
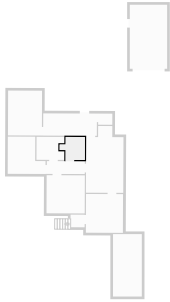

▼ **Bedroom**
Ground Floor

WIDTH: 2.61 m • LENGTH: 2.15 m
AREA: 5.20 m² • PERIMETER: 10.65 m

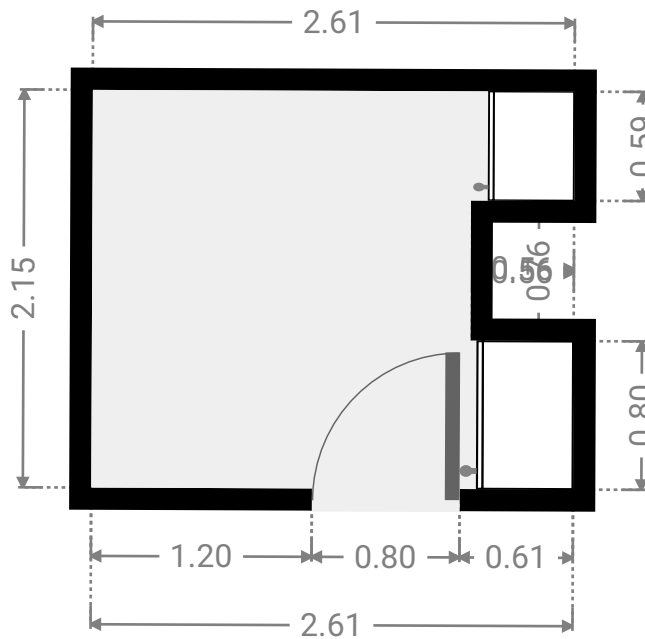
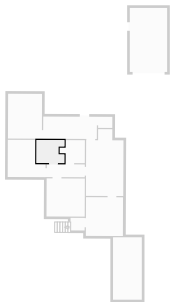

FLOORS: 1

▼ **Bedroom**
Ground Floor

WIDTH: 3.58 m • LENGTH: 3.57 m
AREA: 12.78 m² • PERIMETER: 14.30 m

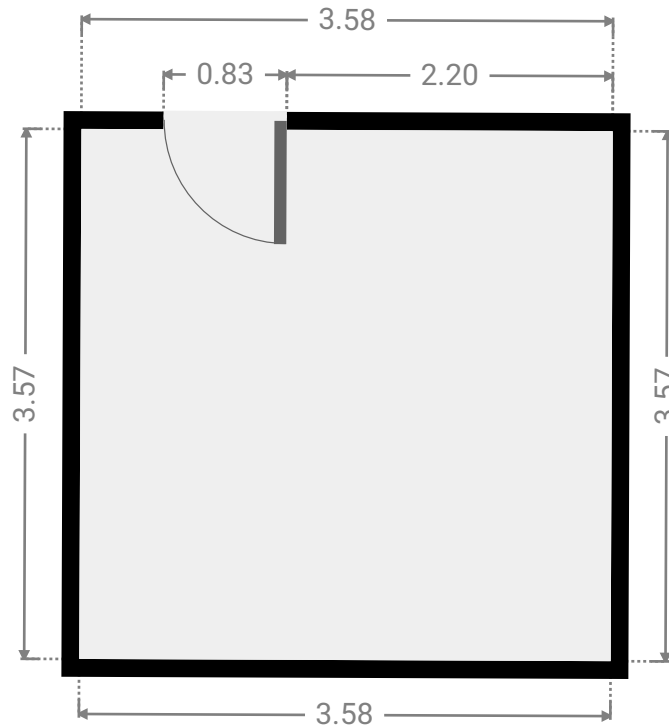
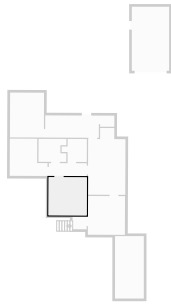

▼ **Bedroom**
Ground Floor

WIDTH: 3.54 m • LENGTH: 3.49 m
AREA: 10.14 m² • PERIMETER: 14.06 m

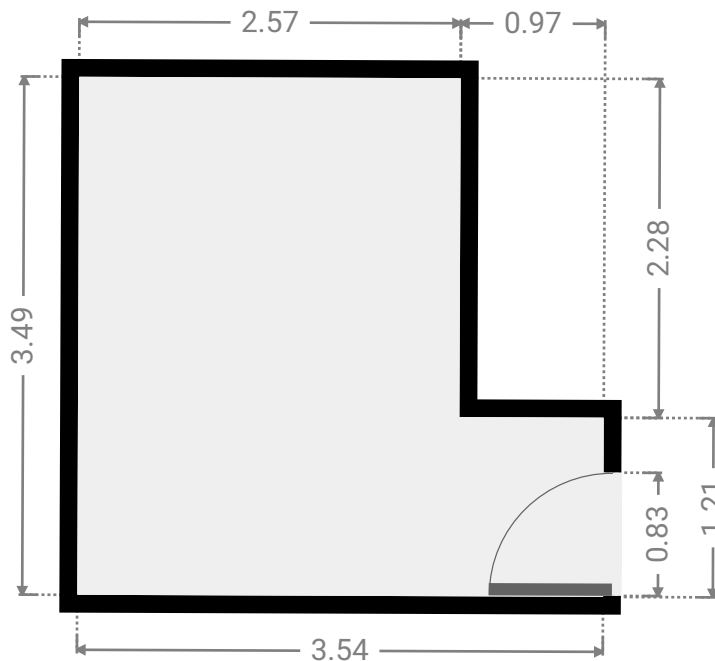
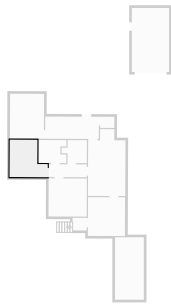

▼ Laundry Room
Ground Floor

WIDTH: 5.03 m • LENGTH: 2.08 m
AREA: 10.46 m² • PERIMETER: 14.22 m

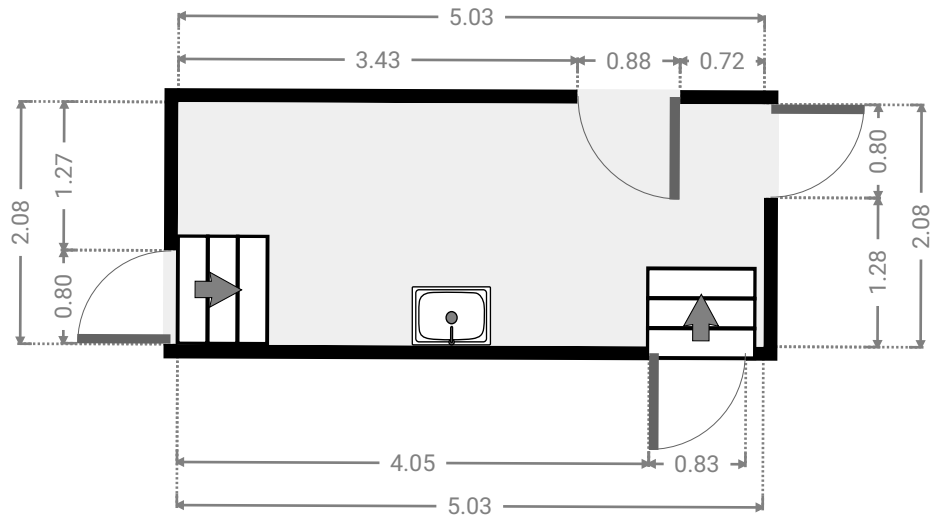
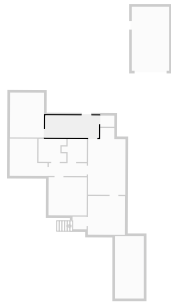

▼ Toilet
Ground Floor

WIDTH: 1.33 m • LENGTH: 1.04 m
AREA: 1.38 m² • PERIMETER: 4.74 m

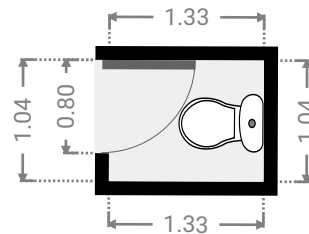
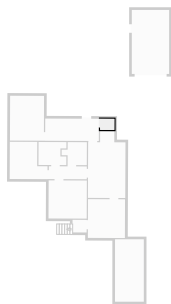

FLOORS: 1

▼ Master Bedroom
Ground Floor

WIDTH: 3.18 m • LENGTH: 4.20 m
AREA: 13.36 m² • PERIMETER: 14.76 m

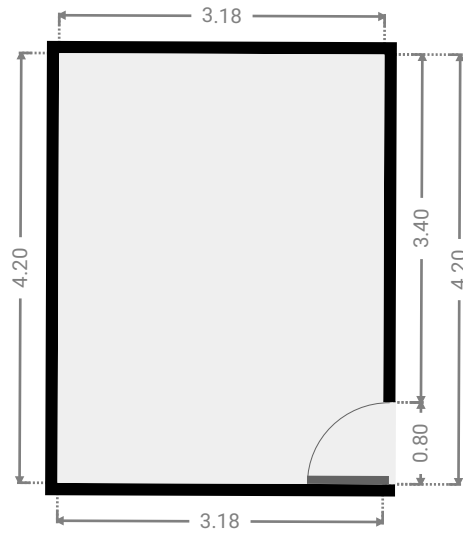
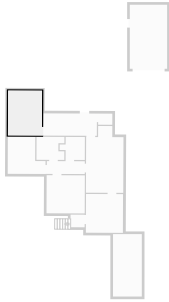

▼ Garage
Ground Floor

WIDTH: 3.50 m • LENGTH: 6.00 m
AREA: 21.00 m² • PERIMETER: 19.00 m

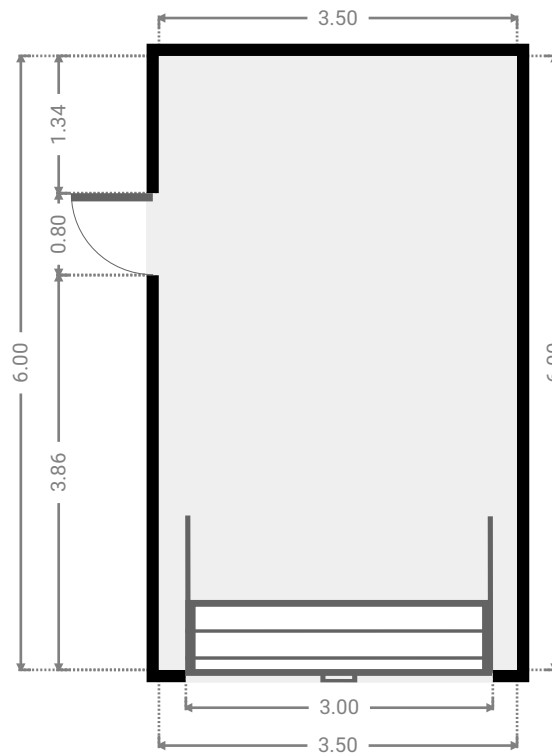
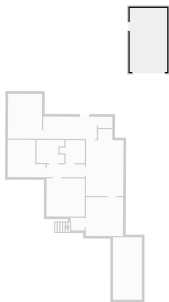

▼ **Carpport**
Ground Floor

WIDTH: 2.70 m • LENGTH: 5.85 m
AREA: 15.79 m² • PERIMETER: 17.10 m

