

253 Rockonia Road

Created on
2020-10-20

Floors
2

▼ Ground Floor

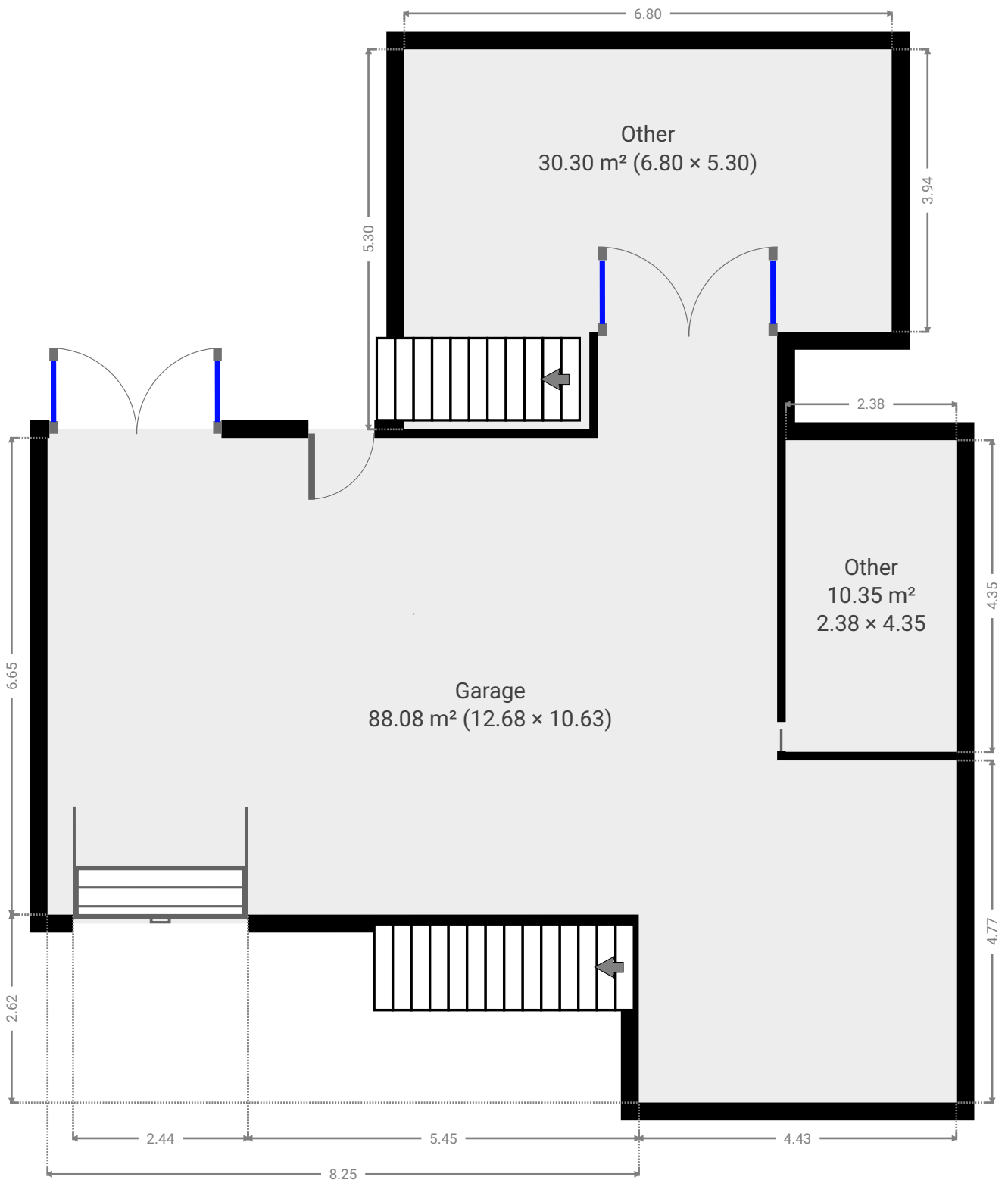

FLOORS:2

▼ **Garage**
Ground Floor

WIDTH:12.68 m · LENGTH:10.63 m
AREA:88.08 m² · PERIMETER:46.62 m

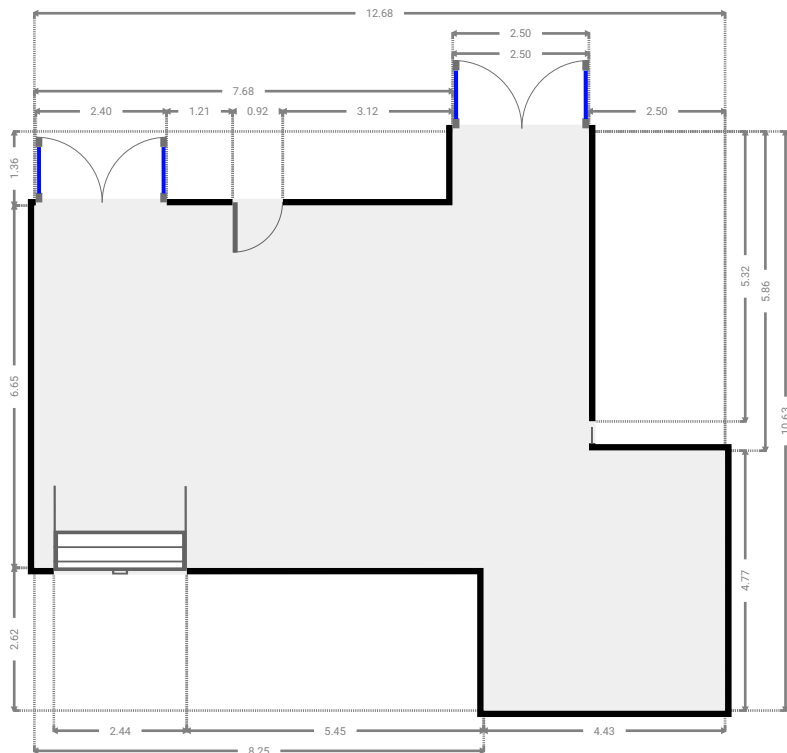
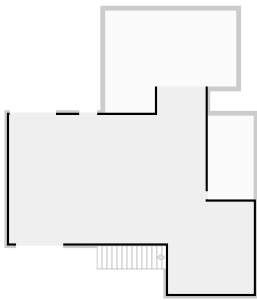

▼ **Other**
Ground Floor

WIDTH:2.38 m · LENGTH:4.35 m
AREA:10.35 m² · PERIMETER:13.46 m

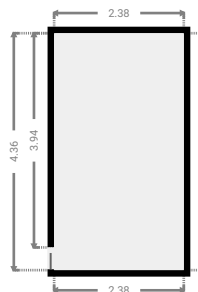
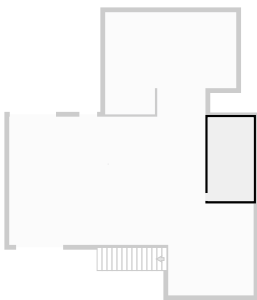

▼ Other
Ground Floor

WIDTH:6.80 m · LENGTH:5.30 m
AREA:30.30 m² · PERIMETER:24.20 m

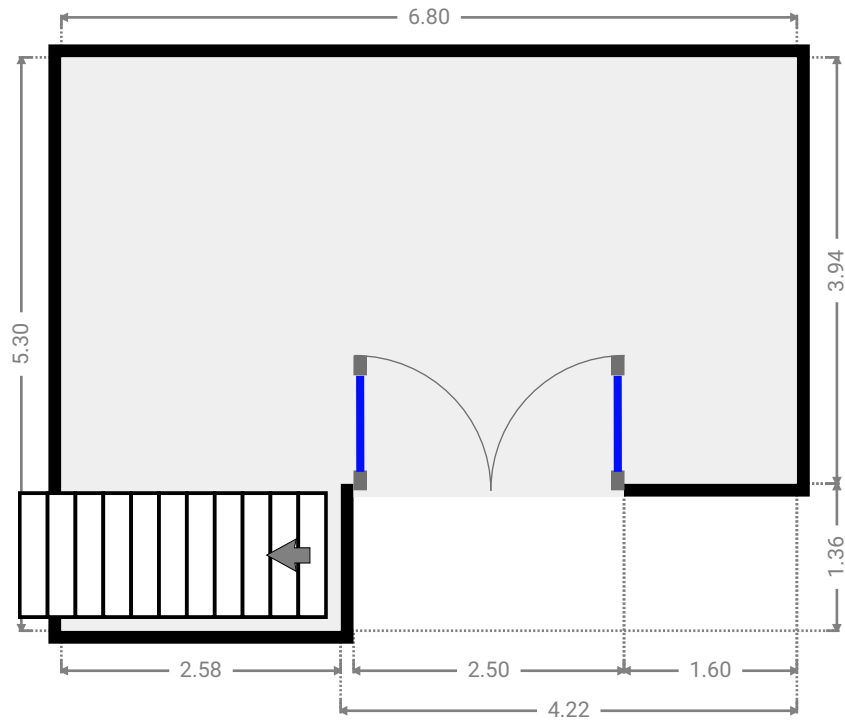
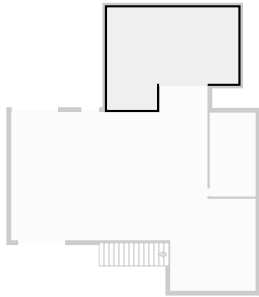

▼ 1st Floor

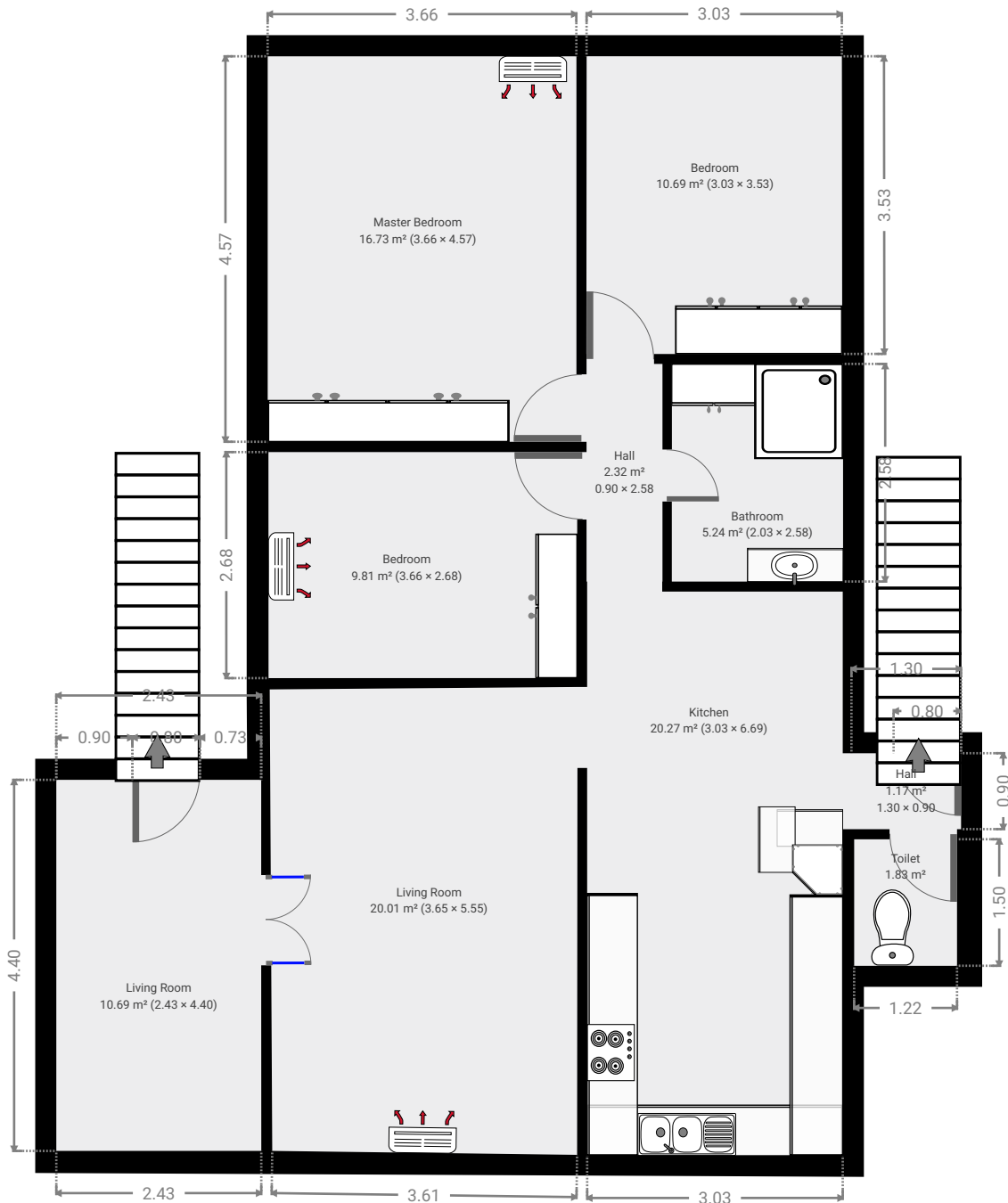

▼ Living Room
1st Floor

WIDTH:4.40 m · LENGTH:2.43 m
AREA:10.69 m² · PERIMETER:13.66 m

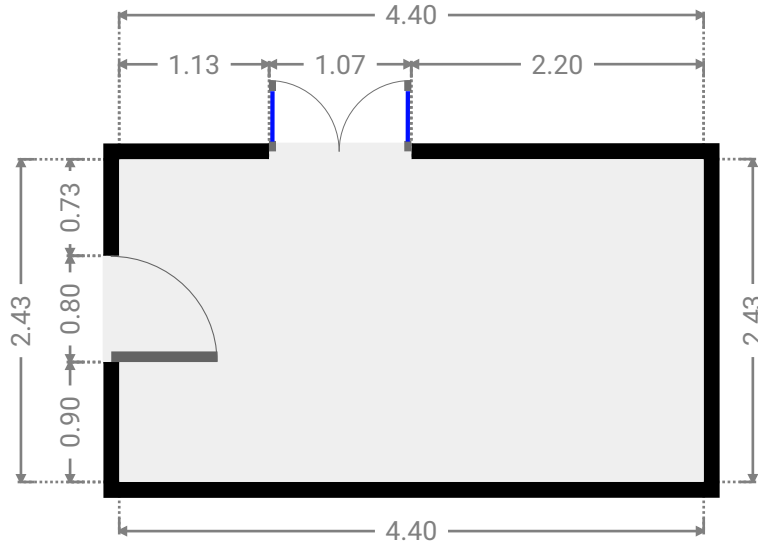
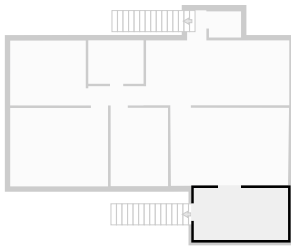

▼ Living Room
1st Floor

WIDTH:5.55 m · LENGTH:3.65 m
AREA:20.01 m² · PERIMETER:18.28 m

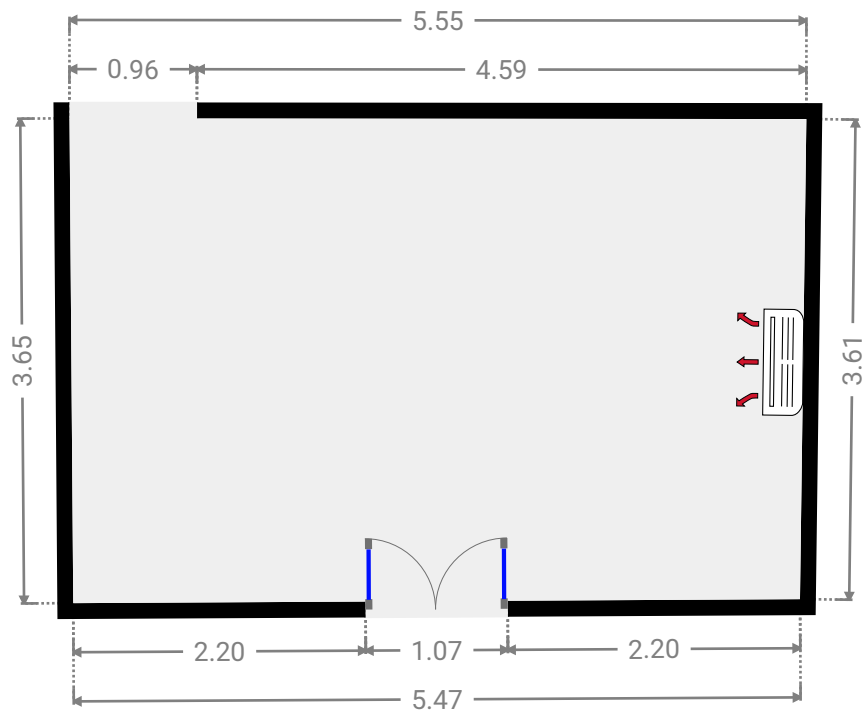
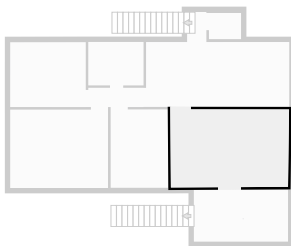

▼ Kitchen
1st Floor

WIDTH:6.69 m · LENGTH:3.03 m
AREA:20.27 m² · PERIMETER:19.44 m

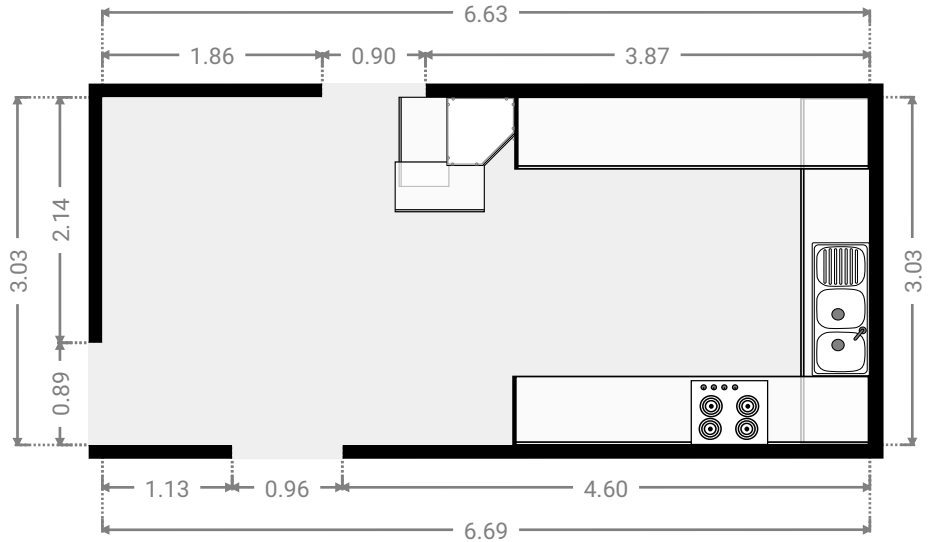
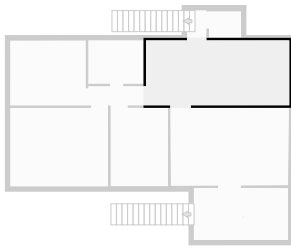

▼ Hall
1st Floor

WIDTH:2.58 m · LENGTH:0.90 m
AREA:2.32 m² · PERIMETER:6.96 m

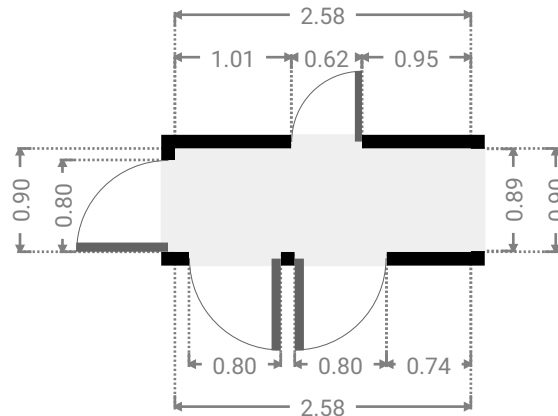
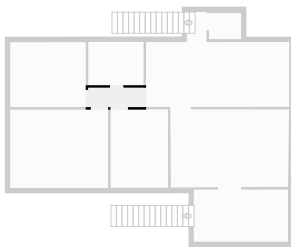

▼ **Bathroom**
1st Floor

WIDTH:2.58 m · LENGTH:2.03 m
AREA:5.24 m² · PERIMETER:9.22 m

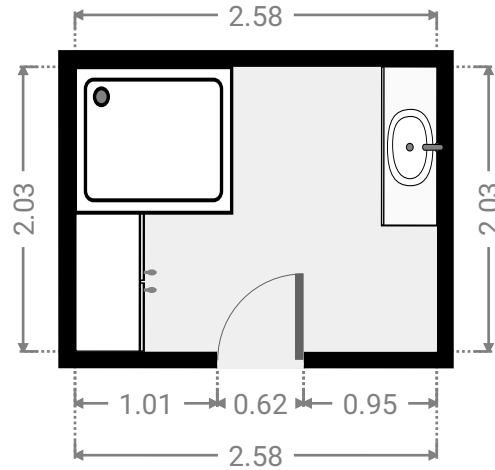
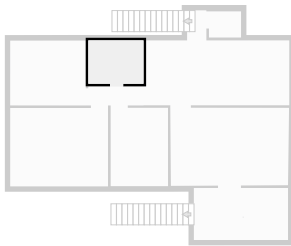

▼ **Bedroom**
1st Floor

WIDTH:2.68 m · LENGTH:3.66 m
AREA:9.81 m² · PERIMETER:12.68 m

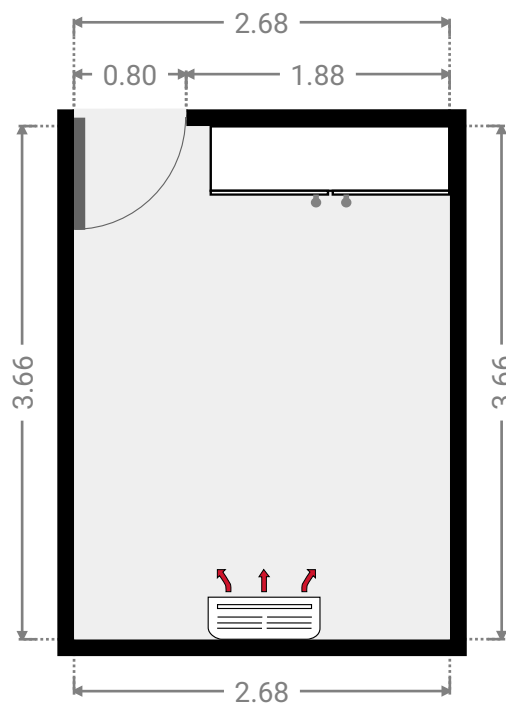
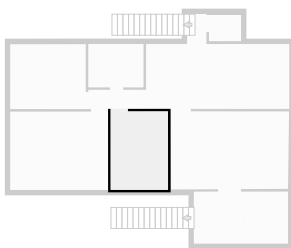

▼ **Master Bedroom**
1st Floor

WIDTH:4.57 m · LENGTH:3.66 m
AREA:16.73 m² · PERIMETER:16.46 m

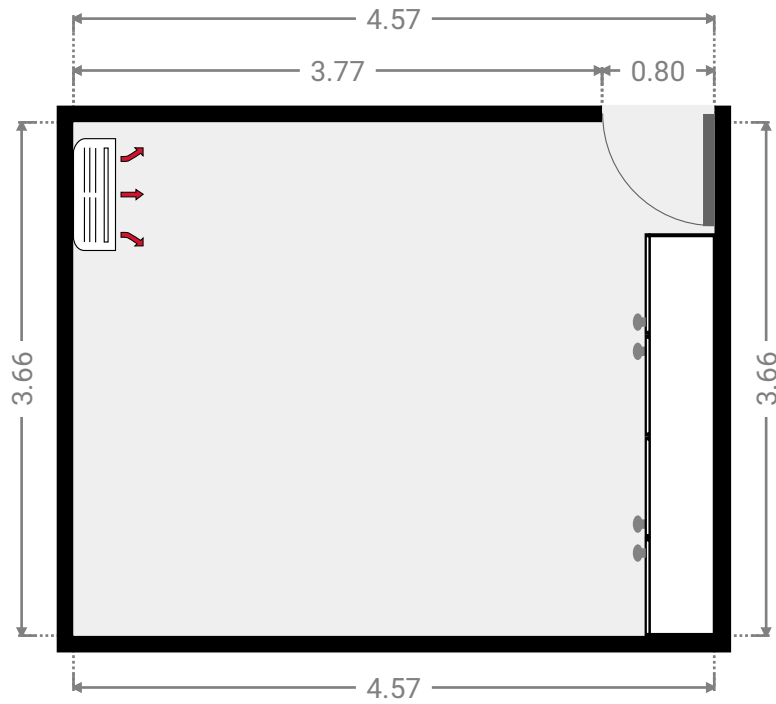
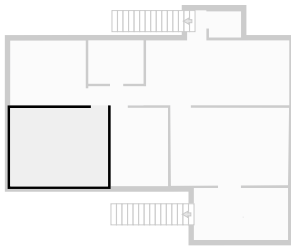

▼ **Bedroom**
1st Floor

WIDTH:3.53 m · LENGTH:3.03 m
AREA:10.69 m² · PERIMETER:13.12 m

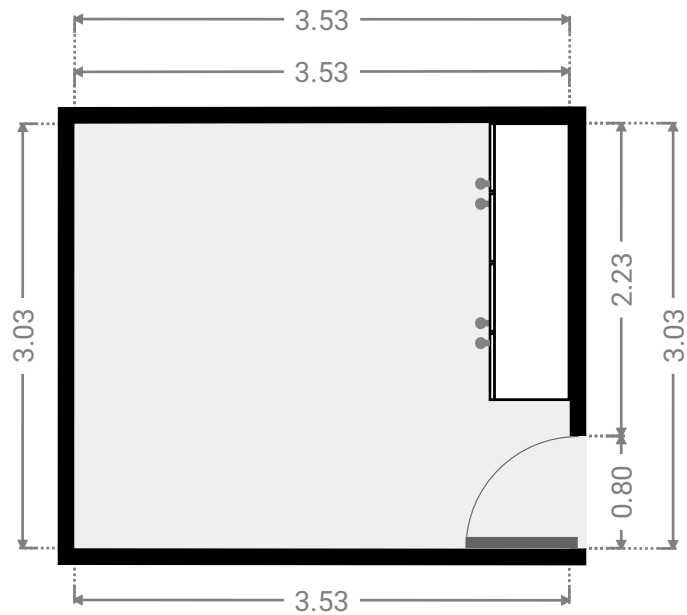
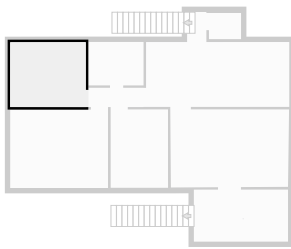

▼ **Hall**
1st Floor

WIDTH:0.90 m · LENGTH:1.30 m
AREA:1.17 m² · PERIMETER:4.40 m

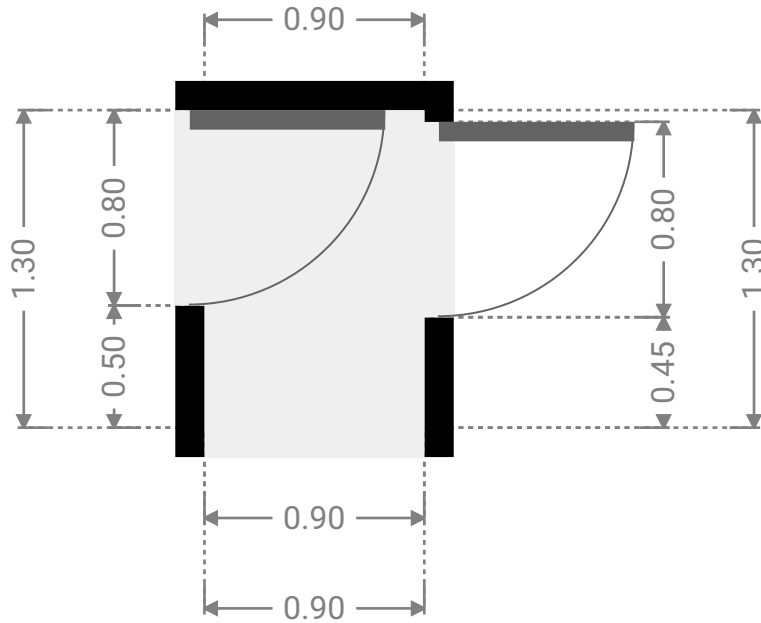
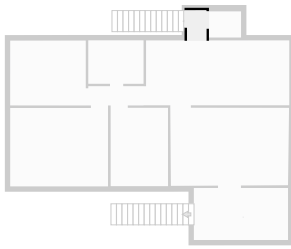

▼ **Toilet**
1st Floor

WIDTH:1.50 m · LENGTH:1.22 m
AREA:1.83 m² · PERIMETER:5.44 m

