

Ground Floor

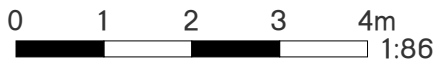
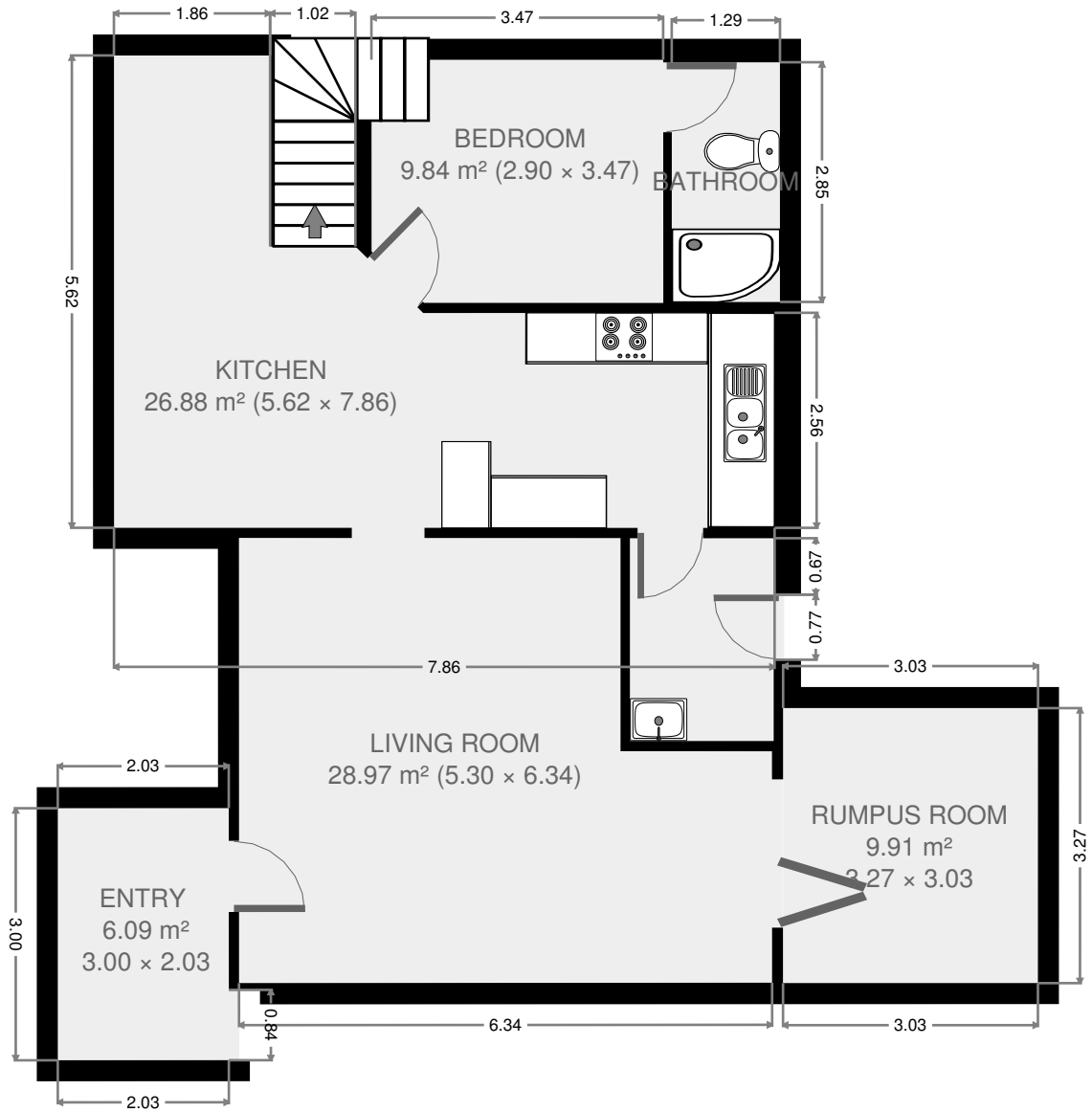

253 Richardson Road

THIS FLOORPLAN IS PROVIDED WITHOUT WARRANTY OF ANY KIND. SENSOPIA DISCLAIMS ANY WARRANTY INCLUDING, WITHOUT LIMITATION, SATISFACTORY QUALITY OR ACCURACY OF DIMENSIONS.

Living Room

Width: 5.30 m
 Length: 6.34 m
 Area: 28.97 m²
 Perimeter: 23.26 m

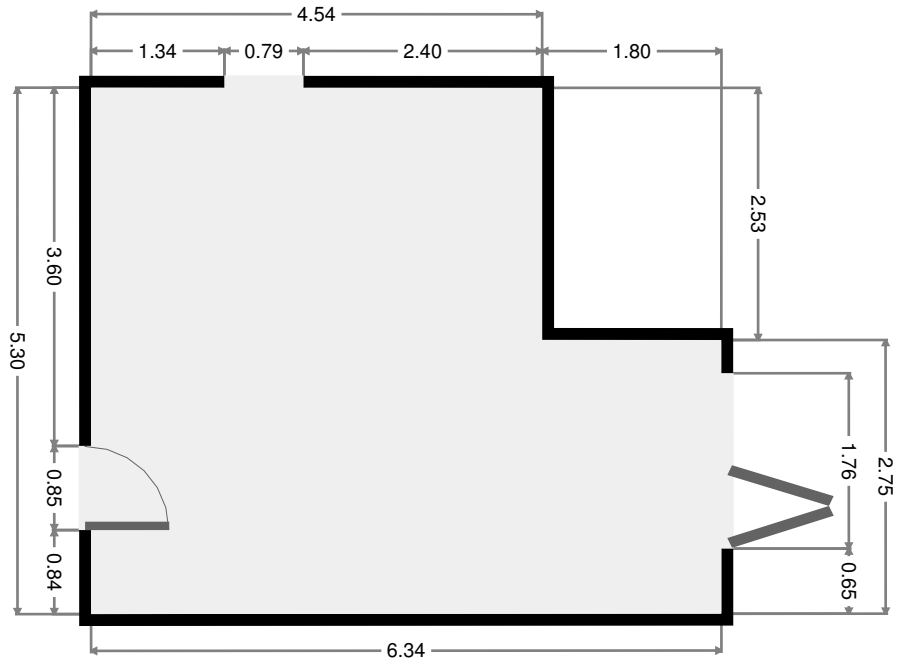
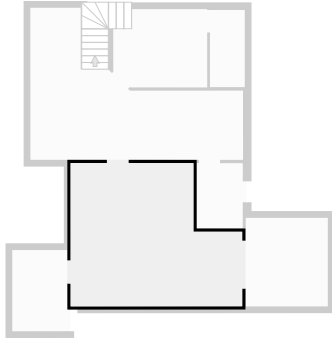

Kitchen

Width: 5.62 m
 Length: 7.86 m
 Area: 26.88 m²
 Perimeter: 26.48 m
 Ceiling Height: 2.17 m

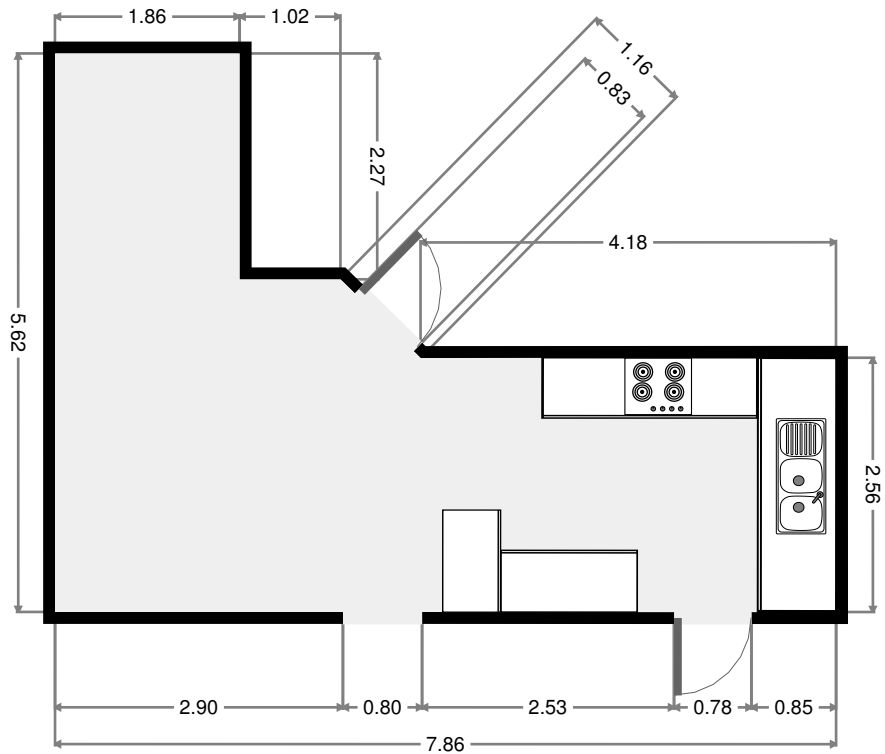
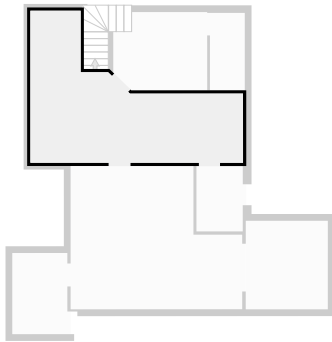

THIS FLOORPLAN IS PROVIDED WITHOUT WARRANTY OF ANY KIND. SENSOPIA DISCLAIMS ANY WARRANTY INCLUDING, WITHOUT LIMITATION, SATISFACTORY QUALITY OR ACCURACY OF DIMENSIONS.

Laundry Room

Width: 1.71 m
 Length: 2.41 m
 Area: 4.13 m²
 Perimeter: 8.25 m

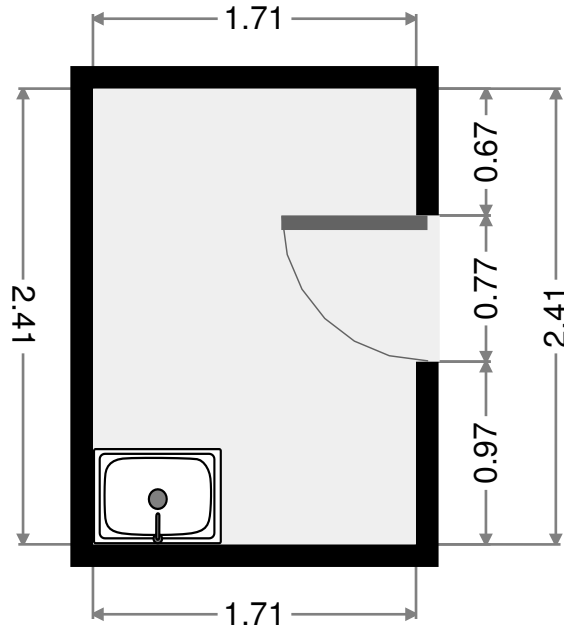
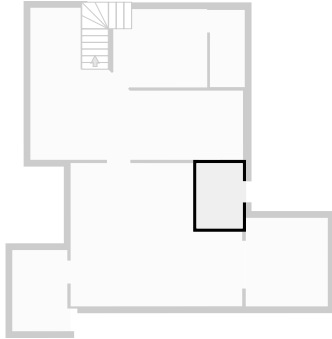

Rumpus Room

Width: 3.03 m
 Length: 3.27 m
 Area: 9.91 m²
 Perimeter: 12.60 m

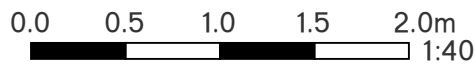
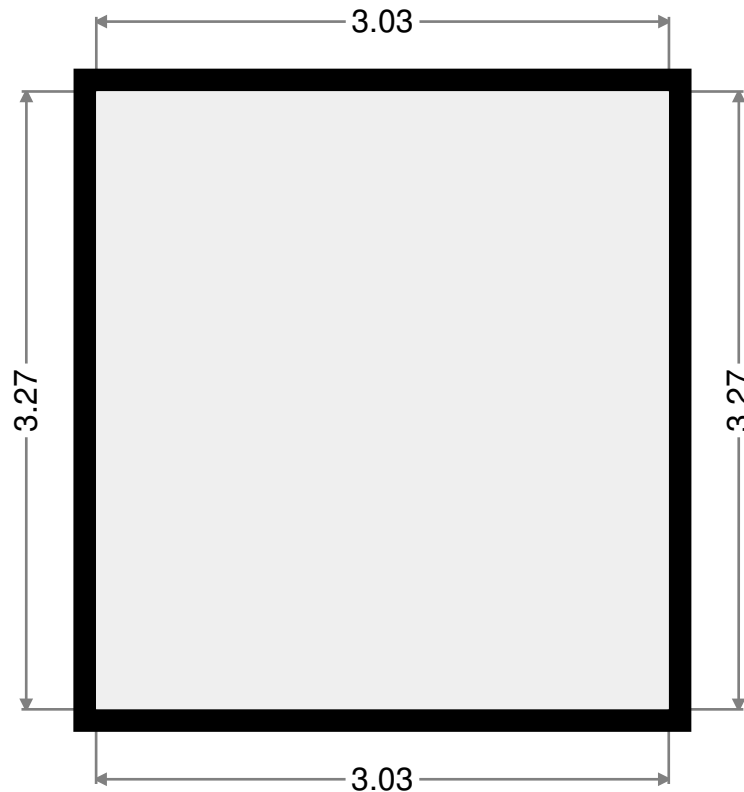
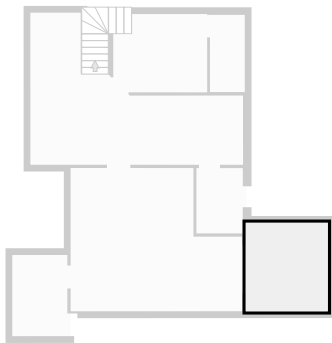

THIS FLOORPLAN IS PROVIDED WITHOUT WARRANTY OF ANY KIND. SENSOPIA DISCLAIMS ANY WARRANTY INCLUDING, WITHOUT LIMITATION, SATISFACTORY QUALITY OR ACCURACY OF DIMENSIONS.

Bedroom

Width: 2.90 m
 Length: 3.47 m
 Area: 9.84 m²
 Perimeter: 12.36 m
 Ceiling Height: 2.17 m

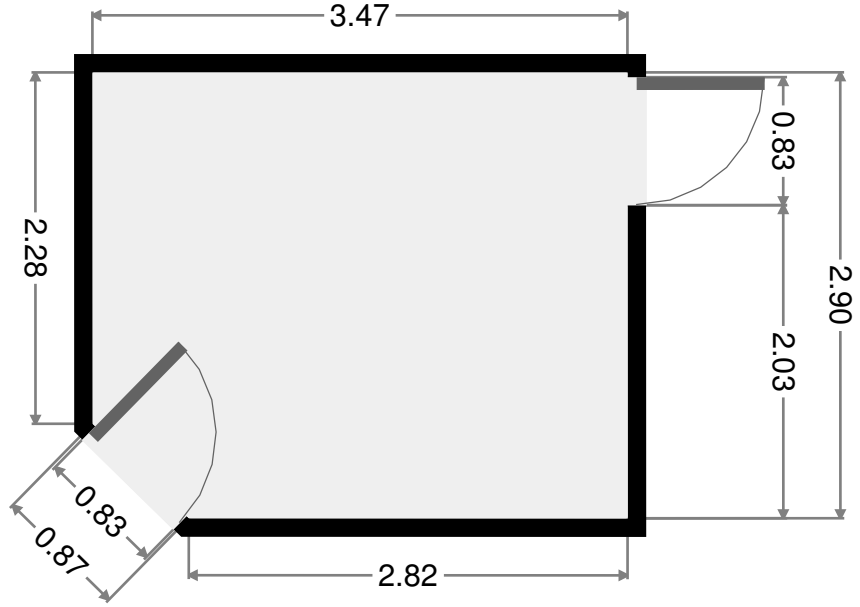
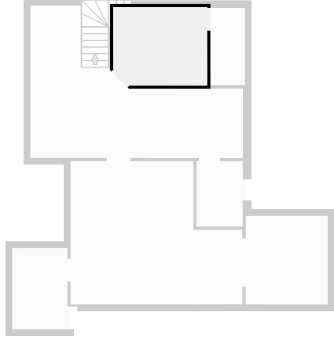

Bathroom

Width: 1.30 m
 Length: 2.85 m
 Area: 3.67 m²
 Perimeter: 8.28 m

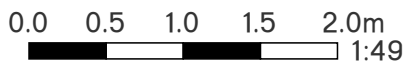
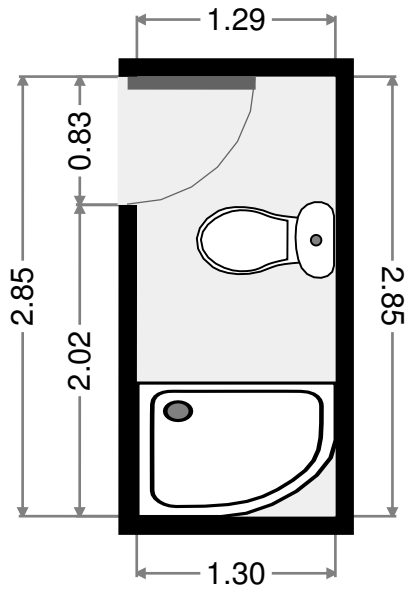
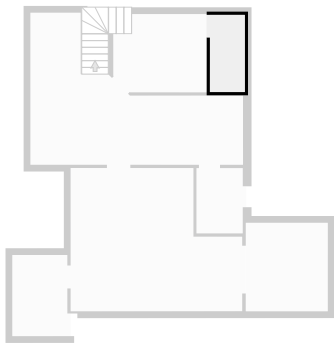

THIS FLOORPLAN IS PROVIDED WITHOUT WARRANTY OF ANY KIND. SENSOPIA DISCLAIMS ANY WARRANTY INCLUDING, WITHOUT LIMITATION, SATISFACTORY QUALITY OR ACCURACY OF DIMENSIONS.

Entry

Width: 2.03 m
Length: 3.00 m
Area: 6.09 m²
Perimeter: 10.06 m

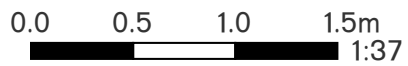
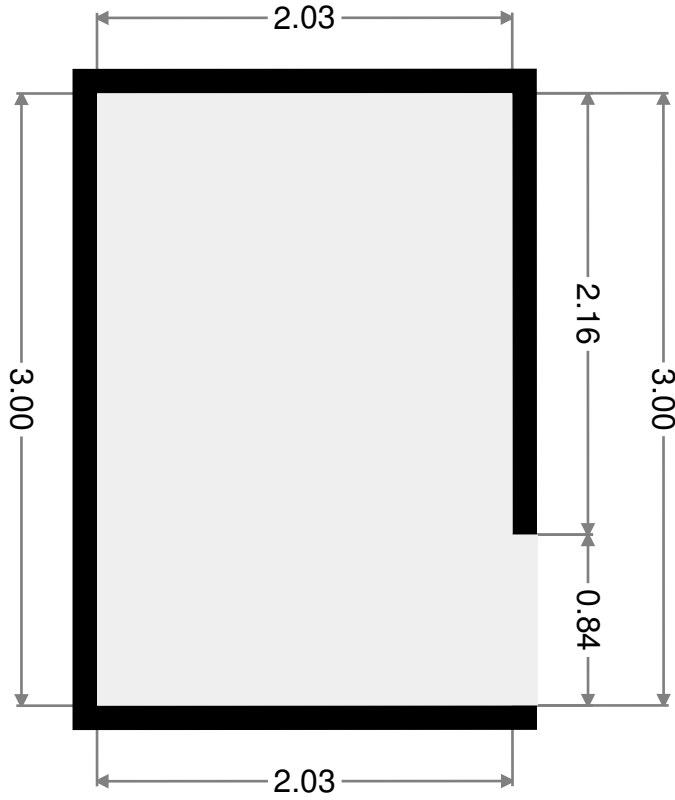
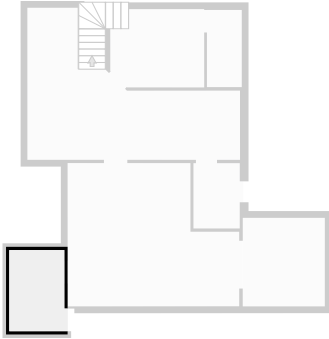

THIS FLOORPLAN IS PROVIDED WITHOUT WARRANTY OF ANY KIND. SENSOPIA DISCLAIMS ANY WARRANTY INCLUDING, WITHOUT LIMITATION, SATISFACTORY QUALITY OR ACCURACY OF DIMENSIONS.

1st Floor

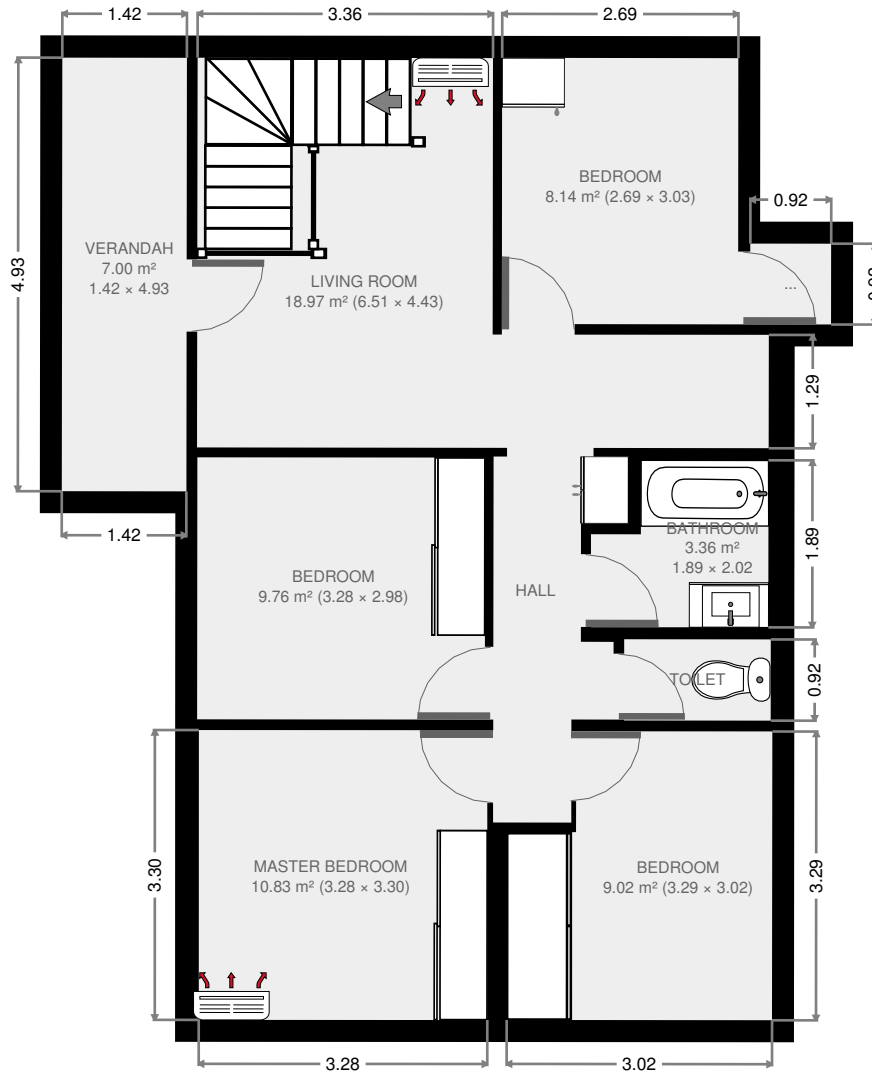

THIS FLOORPLAN IS PROVIDED WITHOUT WARRANTY OF ANY KIND. SENSOPIA DISCLAIMS ANY WARRANTY INCLUDING, WITHOUT LIMITATION, SATISFACTORY QUALITY OR ACCURACY OF DIMENSIONS.

253 Richardson Road

Living Room

Width: 4.43 m
 Length: 6.51 m
 Area: 18.97 m²
 Perimeter: 21.88 m

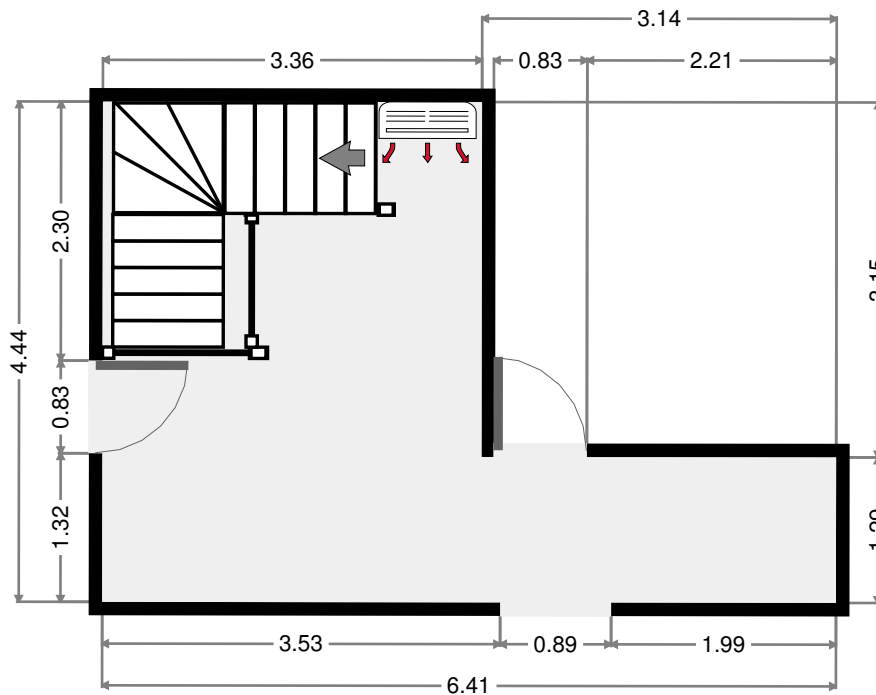
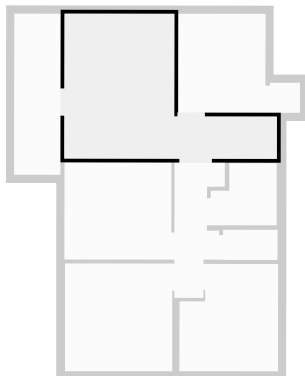

Bedroom

Width: 2.69 m
 Length: 3.03 m
 Area: 8.14 m²
 Perimeter: 11.44 m

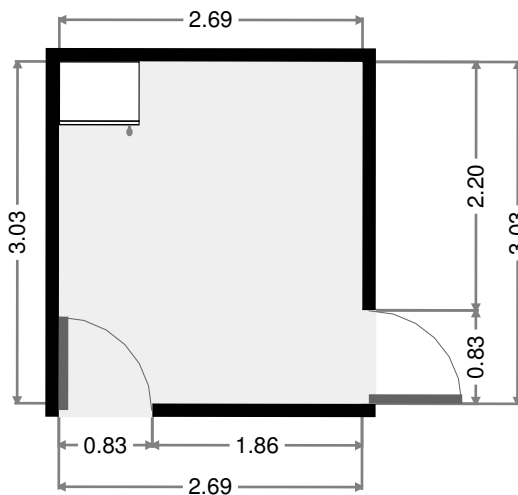
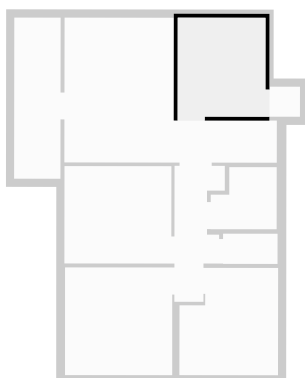

THIS FLOORPLAN IS PROVIDED WITHOUT WARRANTY OF ANY KIND. SENSOPIA DISCLAIMS ANY WARRANTY INCLUDING, WITHOUT LIMITATION, SATISFACTORY QUALITY OR ACCURACY OF DIMENSIONS.

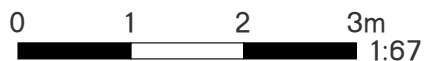

Hall

Width: 1.54 m
 Length: 4.16 m
 Area: 4.76 m²
 Perimeter: 12.15 m

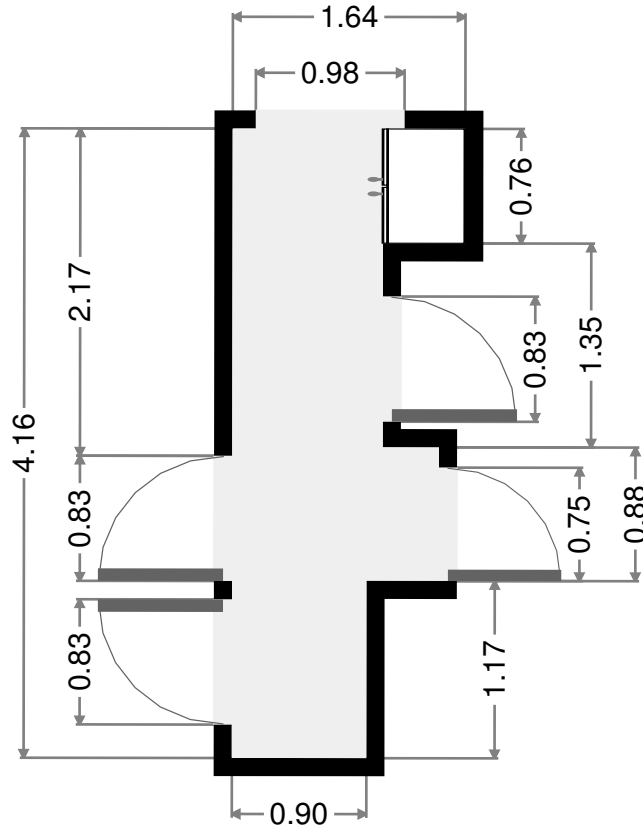
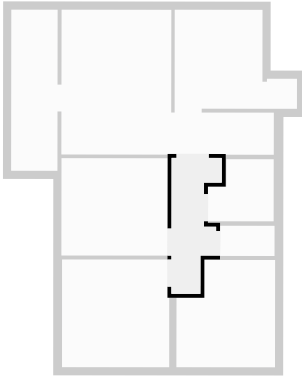

Bathroom

Width: 1.89 m
 Length: 2.02 m
 Area: 3.36 m²
 Perimeter: 7.84 m

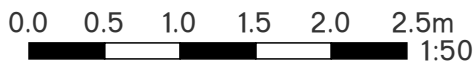
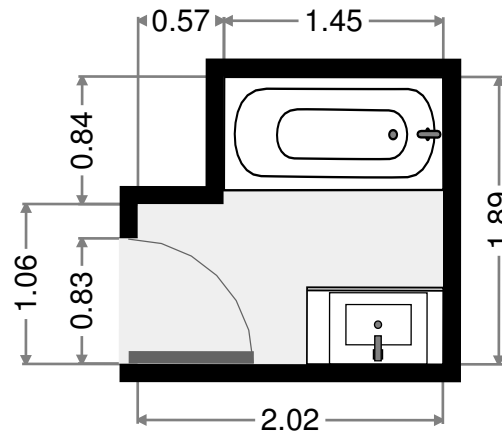
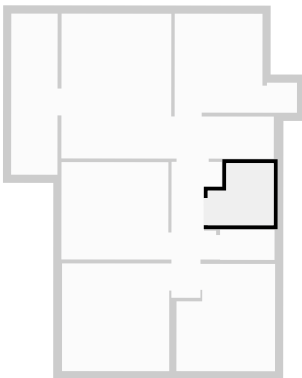

THIS FLOORPLAN IS PROVIDED WITHOUT WARRANTY OF ANY KIND. SENSOPIA DISCLAIMS ANY WARRANTY INCLUDING, WITHOUT LIMITATION, SATISFACTORY QUALITY OR ACCURACY OF DIMENSIONS.

Bedroom

Width: 2.98 m
 Length: 3.28 m
 Area: 9.76 m²
 Perimeter: 12.51 m

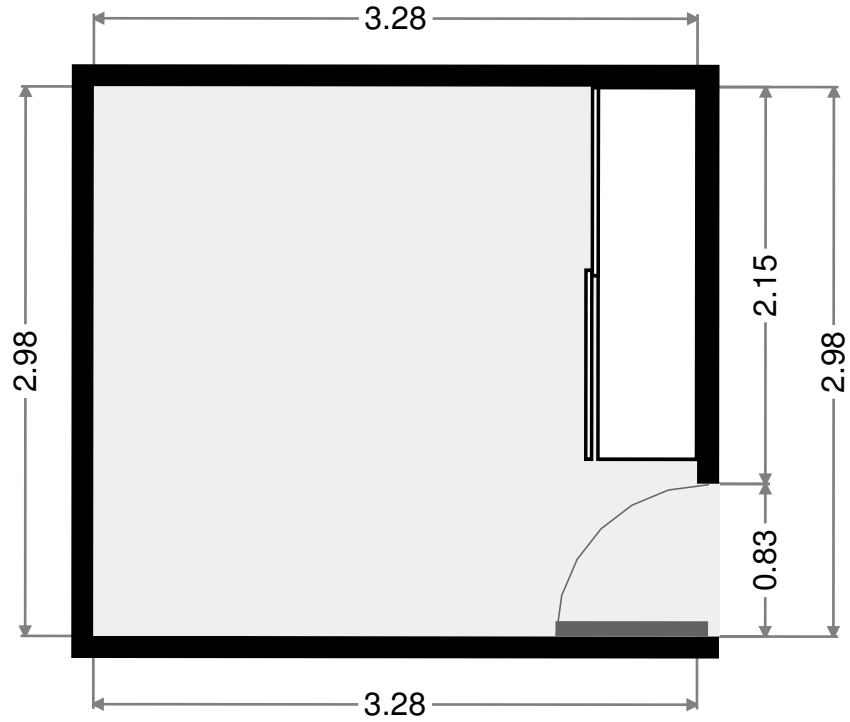
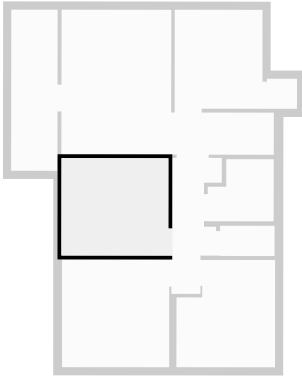

Master Bedroom

Width: 3.28 m
 Length: 3.30 m
 Area: 10.83 m²
 Perimeter: 13.16 m

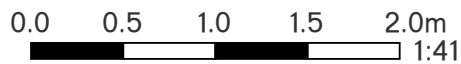
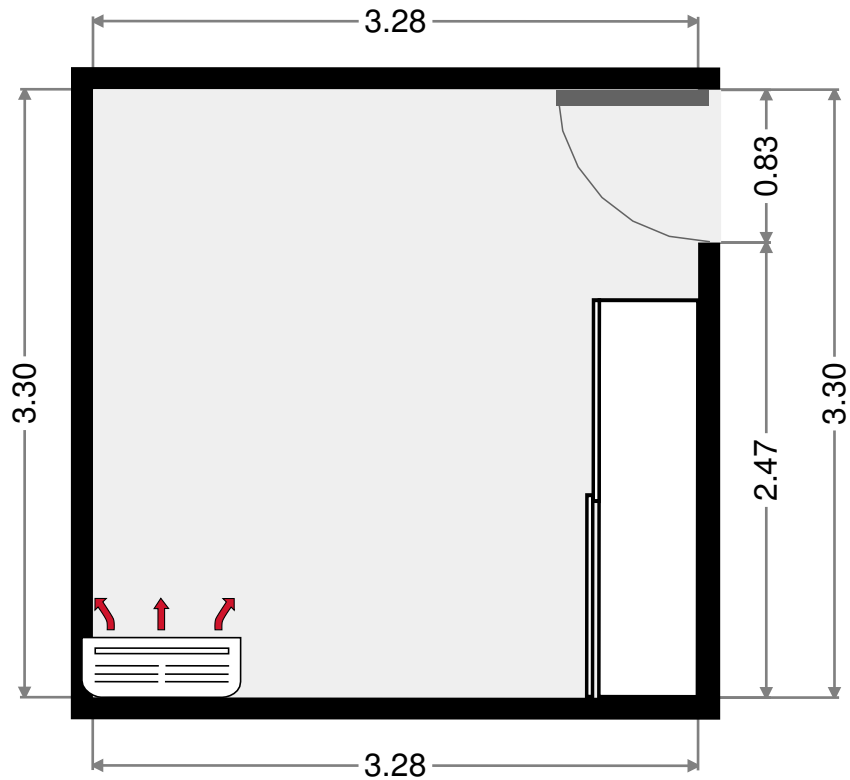
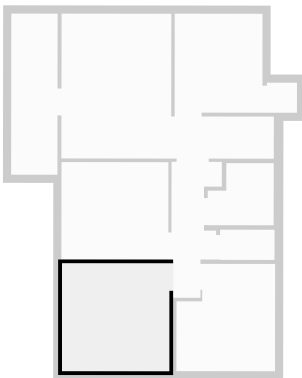

THIS FLOORPLAN IS PROVIDED WITHOUT WARRANTY OF ANY KIND. SENSOPIA DISCLAIMS ANY WARRANTY INCLUDING, WITHOUT LIMITATION, SATISFACTORY QUALITY OR ACCURACY OF DIMENSIONS.

Bedroom

Width: 3.02 m
 Length: 3.29 m
 Area: 9.02 m²
 Perimeter: 12.61 m

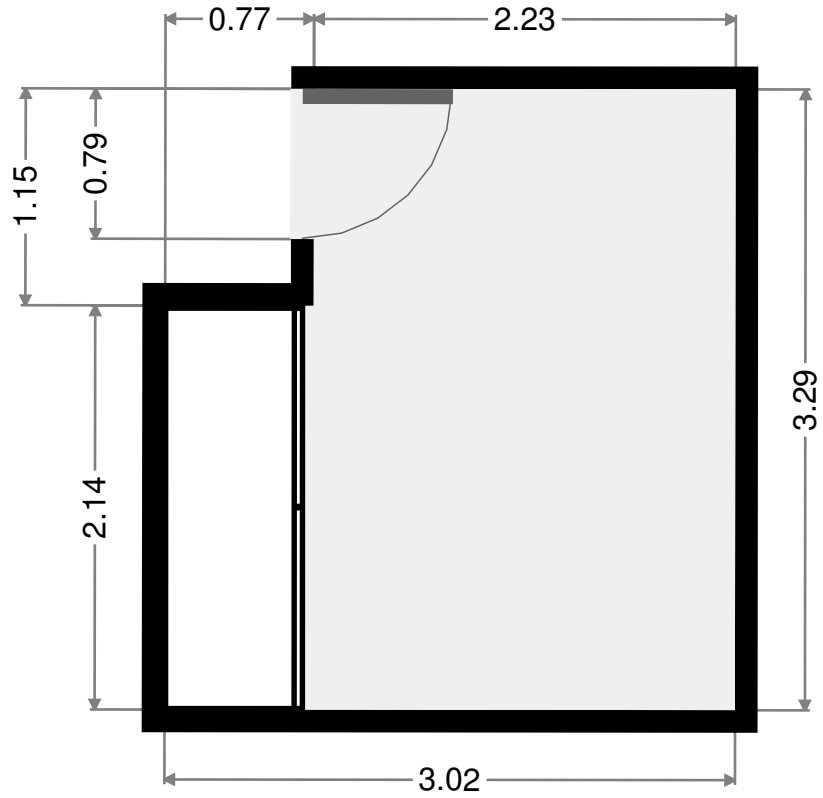
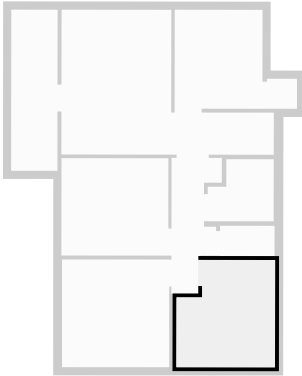

Toilet

Width: 0.92 m
 Length: 1.67 m
 Area: 1.54 m²
 Perimeter: 5.18 m

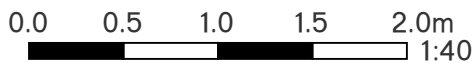
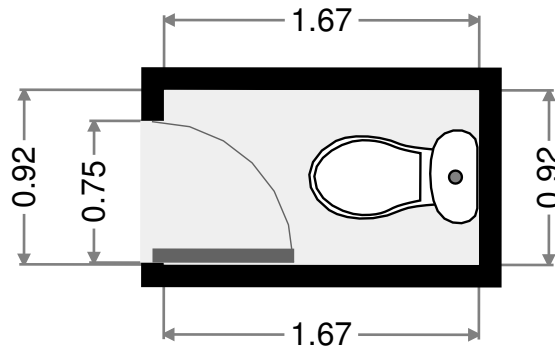
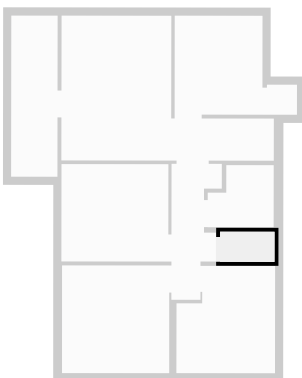

THIS FLOORPLAN IS PROVIDED WITHOUT WARRANTY OF ANY KIND. SENSOPIA DISCLAIMS ANY WARRANTY INCLUDING, WITHOUT LIMITATION, SATISFACTORY QUALITY OR ACCURACY OF DIMENSIONS.

Verandah

Width: 1.42 m
 Length: 4.93 m
 Area: 7.00 m²
 Perimeter: 12.70 m

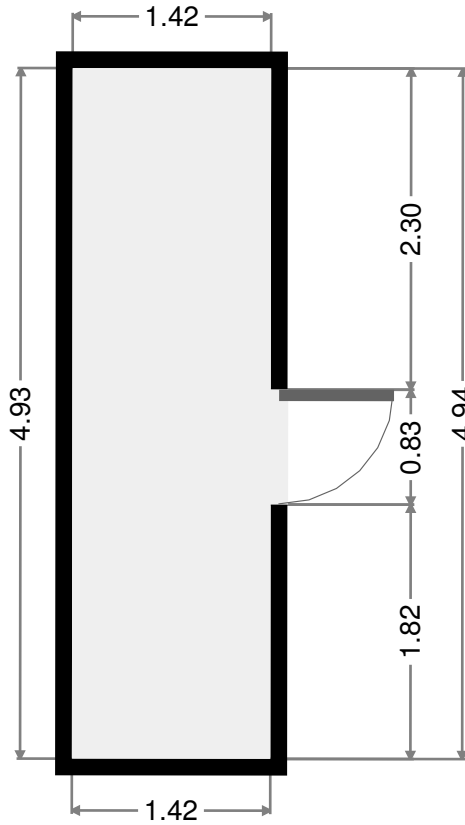
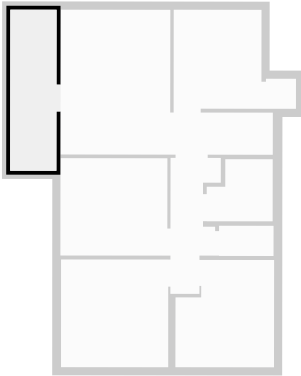

•••

Width: 0.92 m
 Length: 0.92 m
 Area: 0.85 m²
 Perimeter: 3.68 m

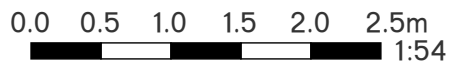
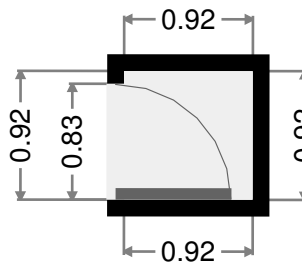
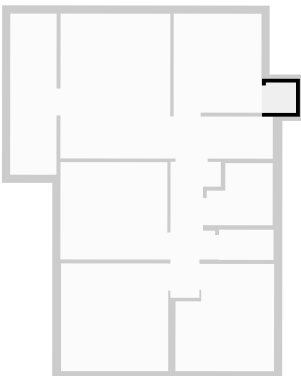

THIS FLOORPLAN IS PROVIDED WITHOUT WARRANTY OF ANY KIND. SENSOPIA DISCLAIMS ANY WARRANTY INCLUDING, WITHOUT LIMITATION, SATISFACTORY QUALITY OR ACCURACY OF DIMENSIONS.