

# 253 Denham Street extended

## Ground Floor

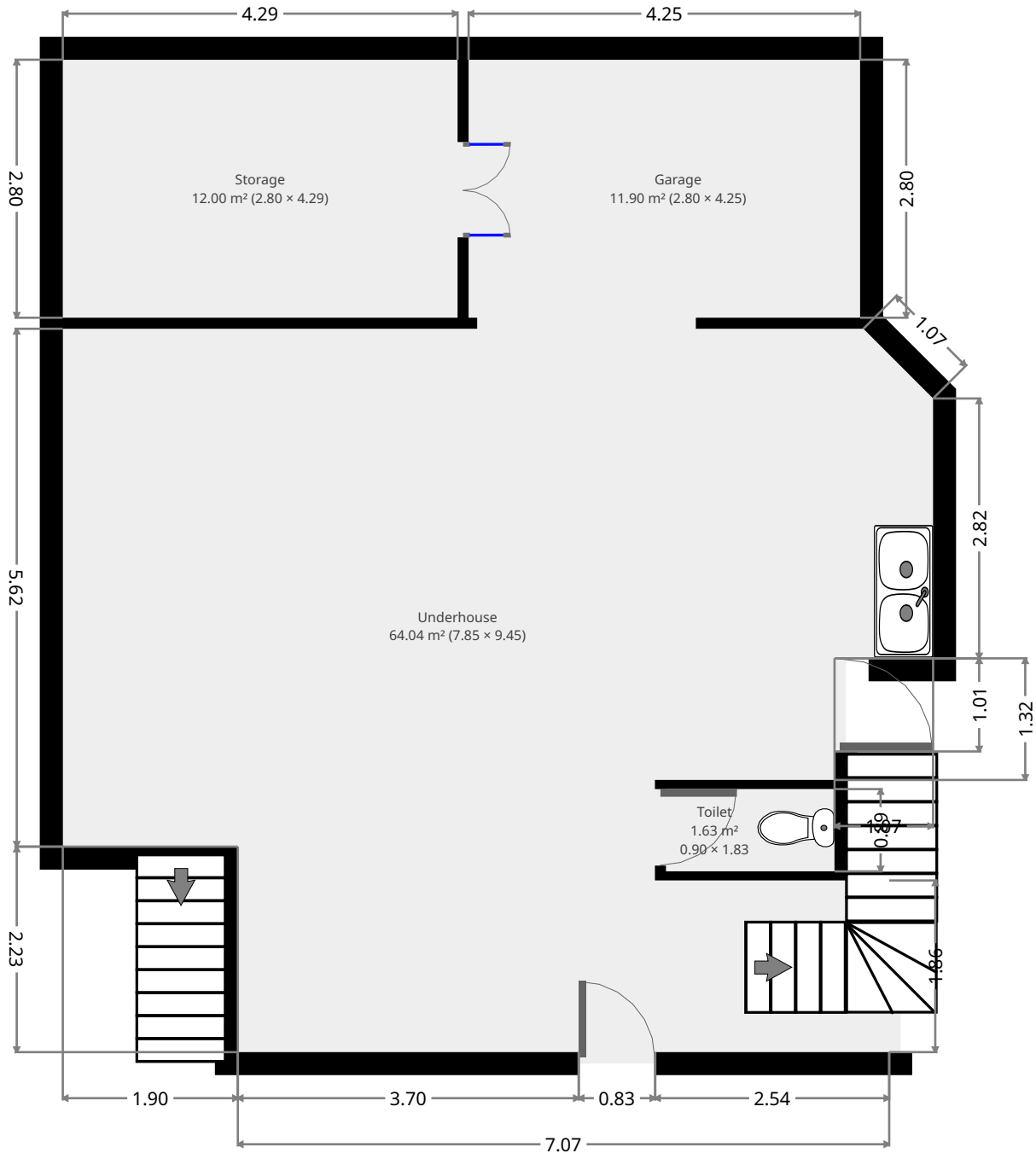

THIS FLOORPLAN IS PROVIDED WITHOUT WARRANTY OF ANY KIND. SENSOPIA DISCLAIMS ANY WARRANTY INCLUDING, WITHOUT LIMITATION, SATISFACTORY QUALITY OR ACCURACY OF DIMENSIONS.



# 253 Denham Street extended

## Underhouse

Width: 7.85 m  
 Length: 9.45 m  
 Area: 64.04 m<sup>2</sup>  
 Perimeter: 39.24 m

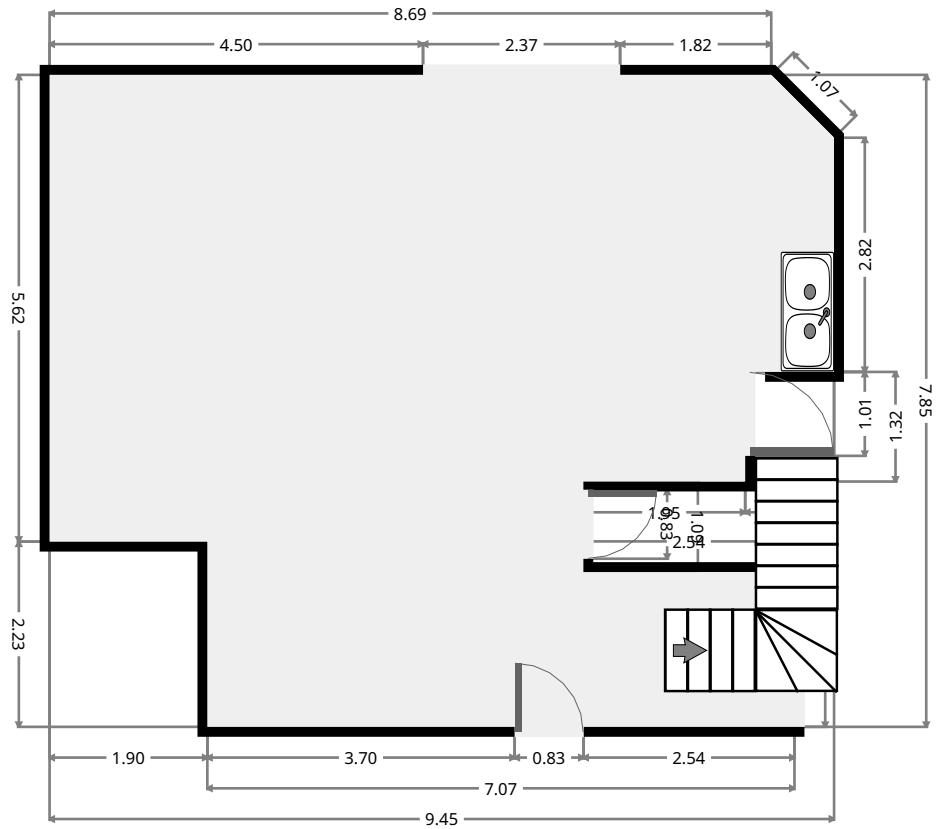
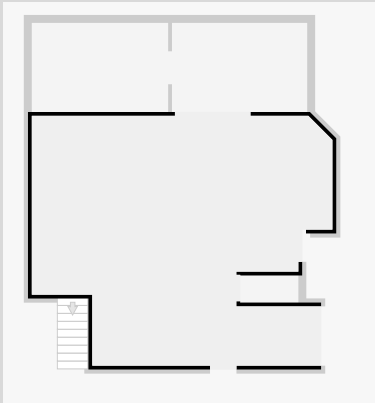

## Toilet

Width: 0.90 m  
 Length: 1.83 m  
 Area: 1.63 m<sup>2</sup>  
 Perimeter: 5.45 m

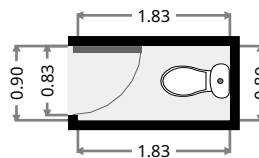
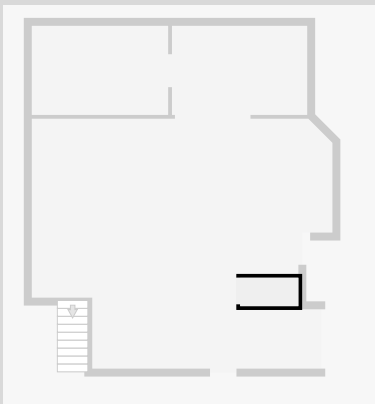

THIS FLOORPLAN IS PROVIDED WITHOUT WARRANTY OF ANY KIND. SENSOPIA DISCLAIMS ANY WARRANTY INCLUDING, WITHOUT LIMITATION, SATISFACTORY QUALITY OR ACCURACY OF DIMENSIONS.

# 253 Denham Street extended

## Garage

Width: 2.80 m  
 Length: 4.25 m  
 Area: 11.90 m<sup>2</sup>  
 Perimeter: 14.10 m

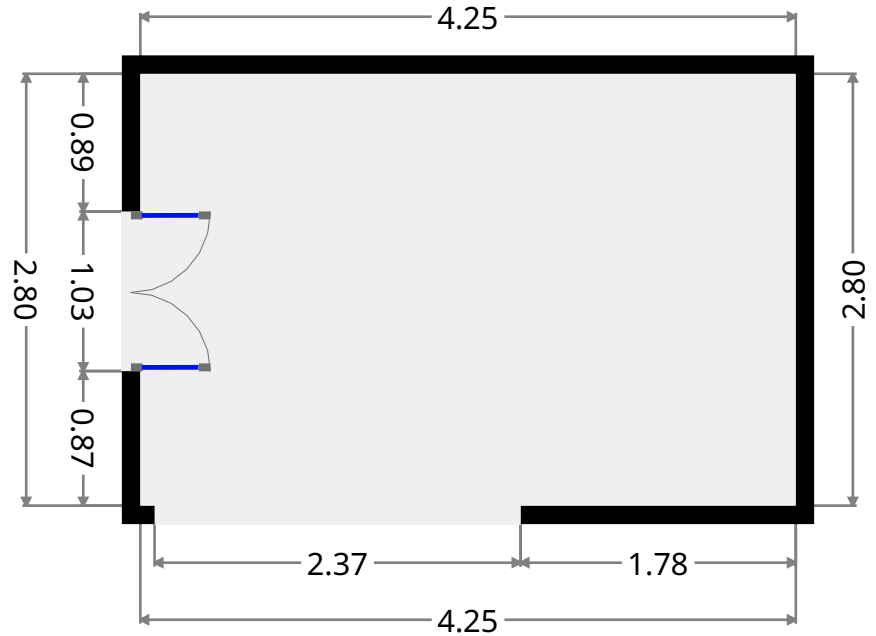
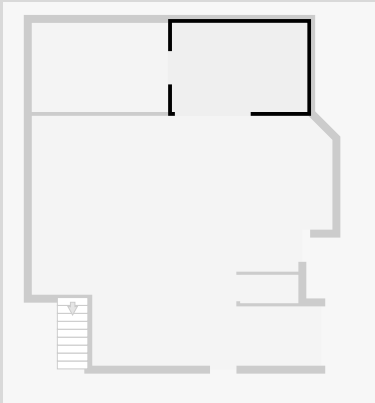

## Storage

Width: 2.80 m  
 Length: 4.29 m  
 Area: 12.00 m<sup>2</sup>  
 Perimeter: 14.17 m

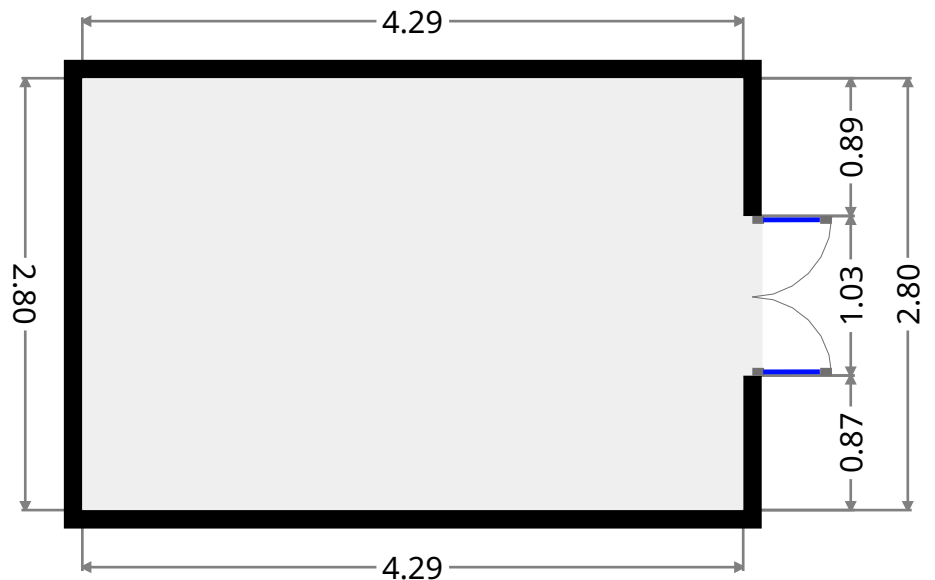
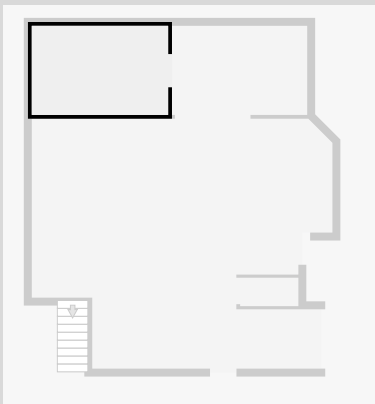

# 253 Denham Street extended

## 1st Floor

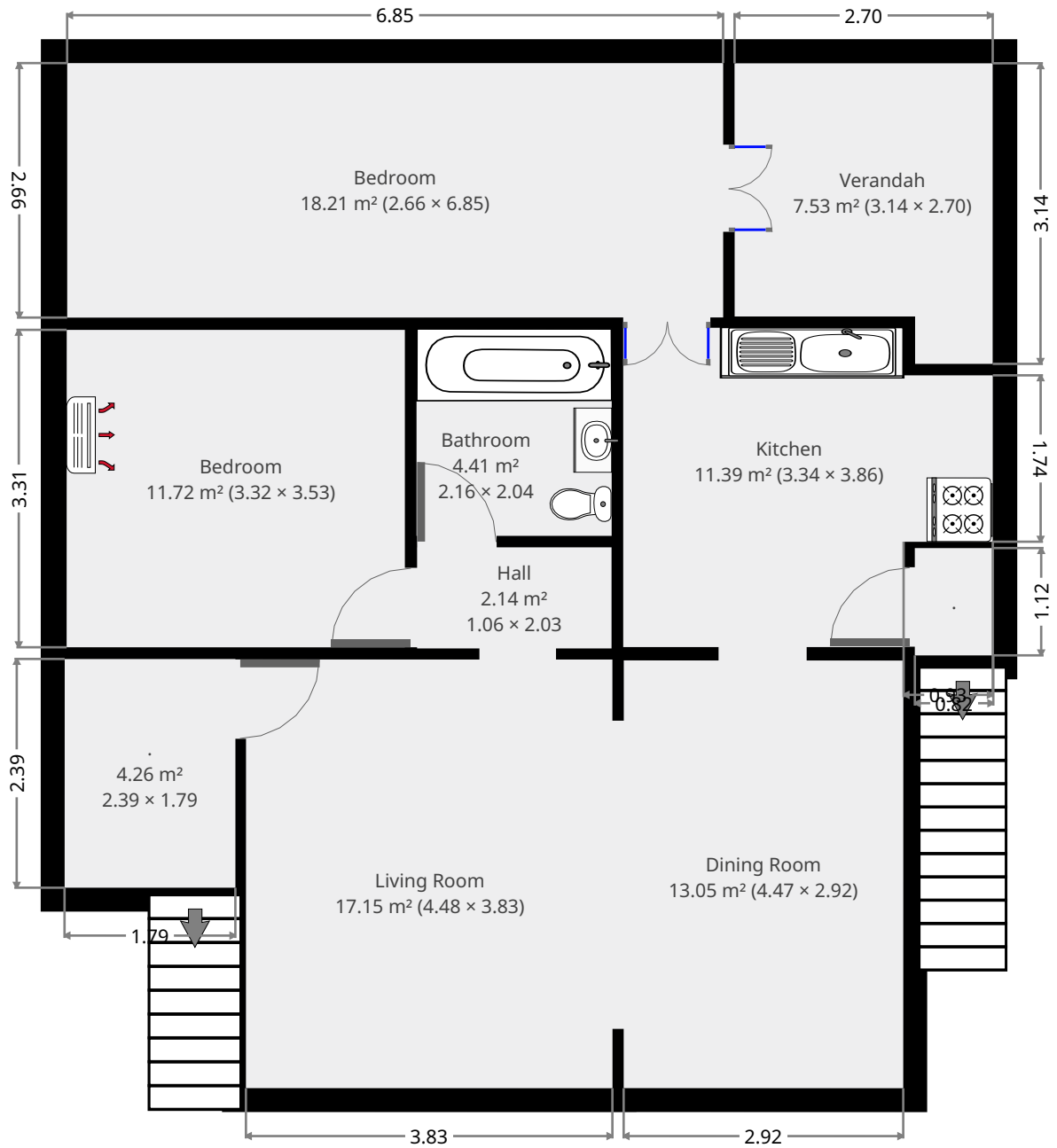

THIS FLOORPLAN IS PROVIDED WITHOUT WARRANTY OF ANY KIND. SENSOPIA DISCLAIMS ANY WARRANTY INCLUDING, WITHOUT LIMITATION, SATISFACTORY QUALITY OR ACCURACY OF DIMENSIONS.

# 253 Denham Street extended

## Living Room

Width: 3.83 m  
 Length: 4.48 m  
 Area: 17.15 m<sup>2</sup>  
 Perimeter: 16.62 m

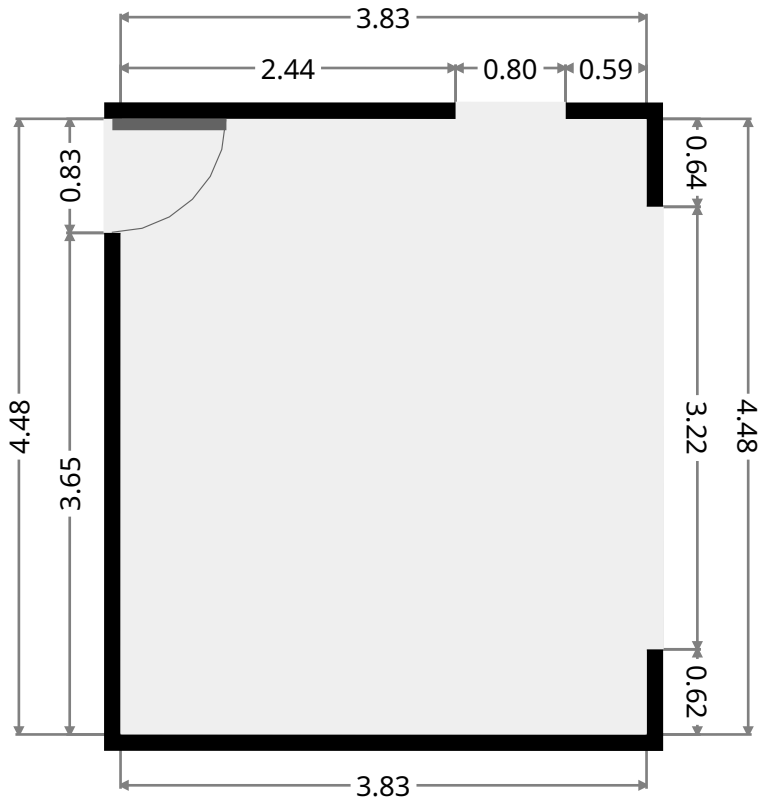
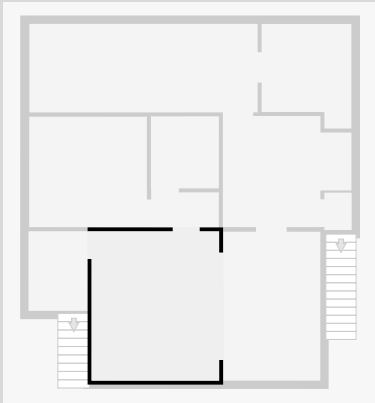

## Dining Room

Width: 2.92 m  
 Length: 4.47 m  
 Area: 13.05 m<sup>2</sup>  
 Perimeter: 14.78 m

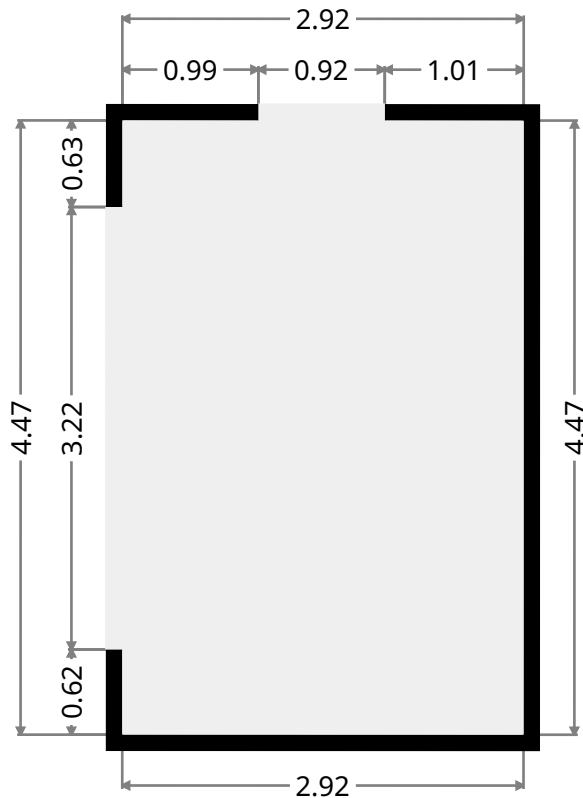
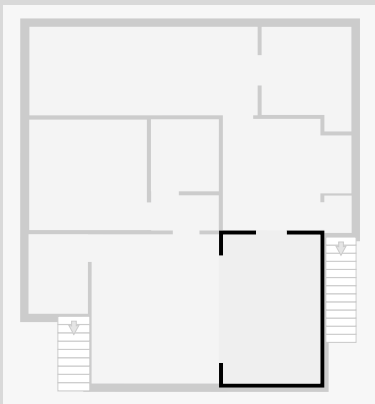

THIS FLOORPLAN IS PROVIDED WITHOUT WARRANTY OF ANY KIND. SENSOPIA DISCLAIMS ANY WARRANTY INCLUDING, WITHOUT LIMITATION, SATISFACTORY QUALITY OR ACCURACY OF DIMENSIONS.

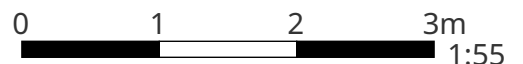

# 253 Denham Street extended

## Kitchen

Width: 3.34 m  
 Length: 3.86 m  
 Area: 11.39 m<sup>2</sup>  
 Perimeter: 14.39 m

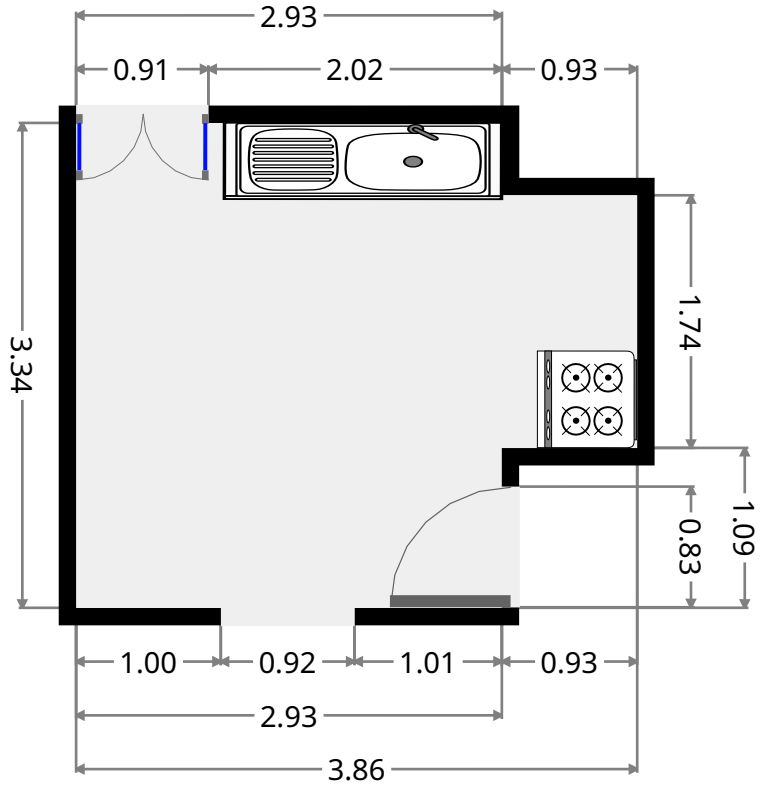
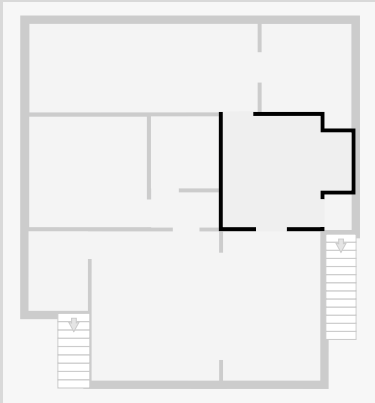

•  
 Width: 0.82 m  
 Length: 1.12 m  
 Area: 0.92 m<sup>2</sup>  
 Perimeter: 3.88 m

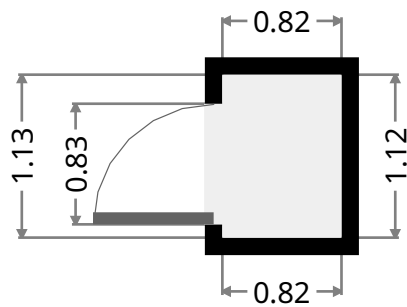
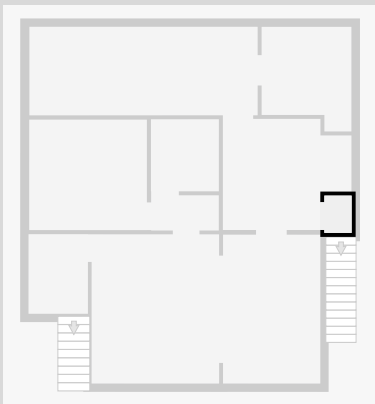

# 253 Denham Street extended

## Bedroom

Width: 2.66 m  
 Length: 6.85 m  
 Area: 18.21 m<sup>2</sup>  
 Perimeter: 19.02 m

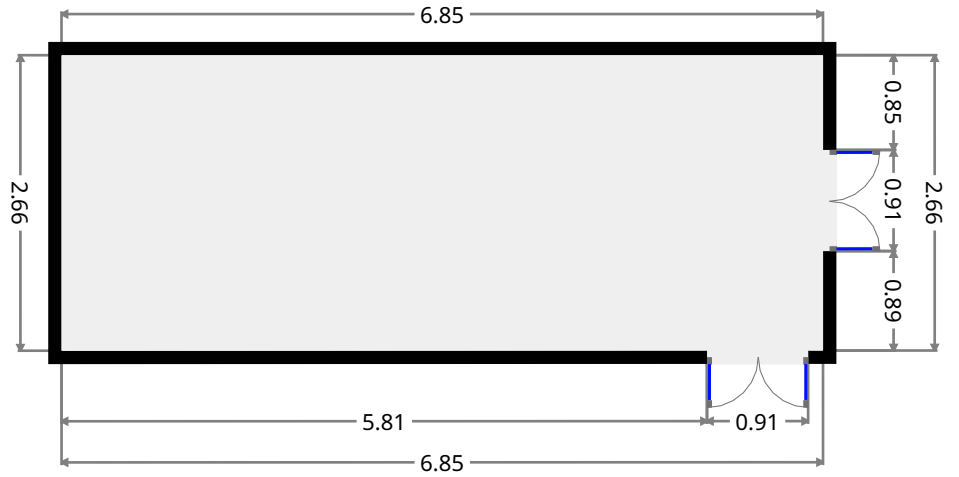
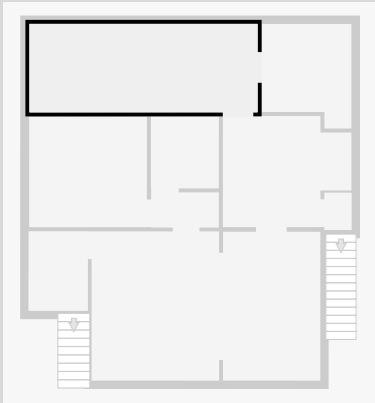

## Bedroom

Width: 3.32 m  
 Length: 3.53 m  
 Area: 11.72 m<sup>2</sup>  
 Perimeter: 13.70 m

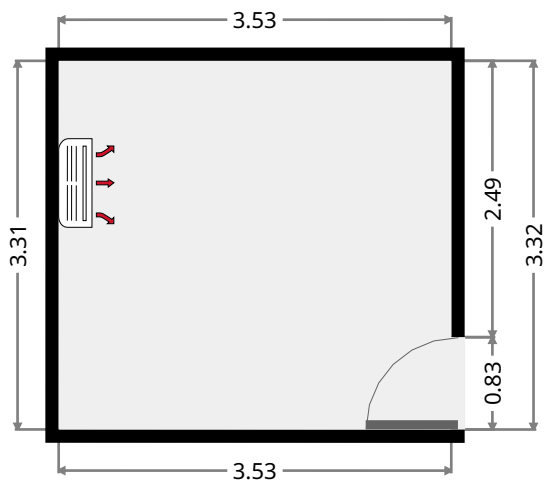
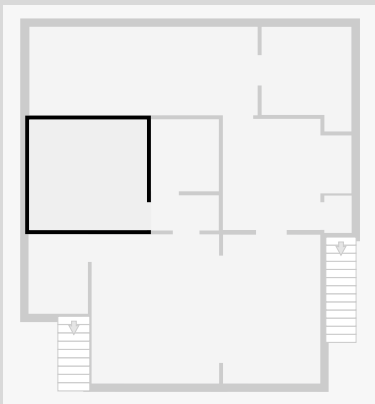

# 253 Denham Street extended

## Hall

Width: 1.06 m  
 Length: 2.03 m  
 Area: 2.14 m<sup>2</sup>  
 Perimeter: 6.17 m

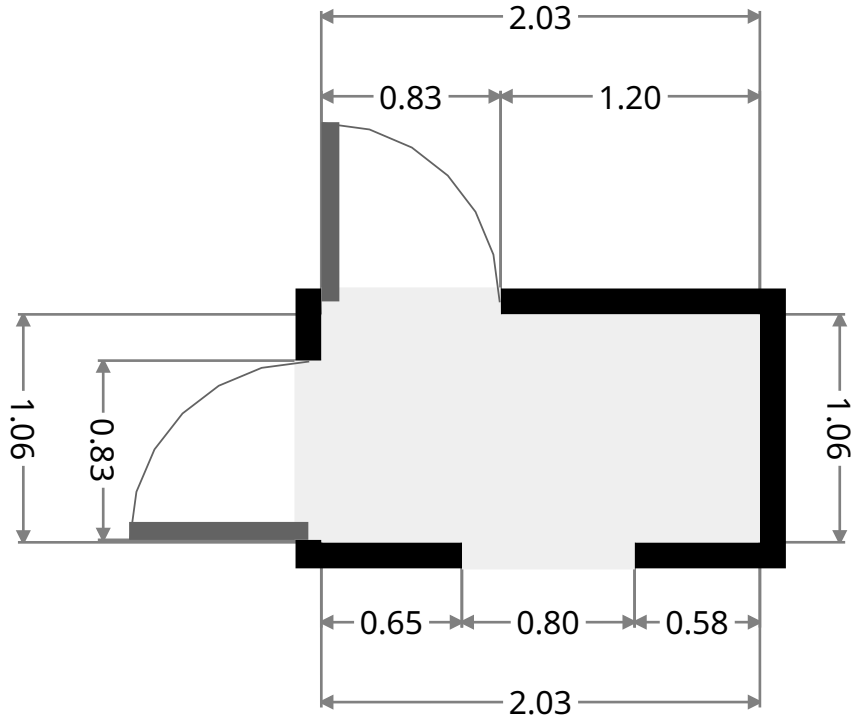
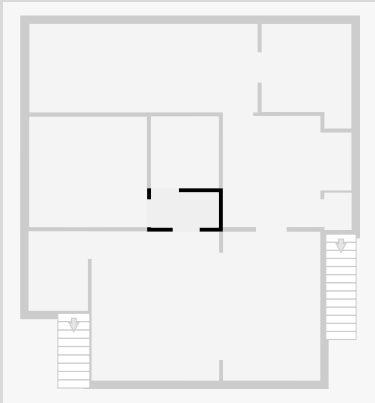

## Bathroom

Width: 2.04 m  
 Length: 2.16 m  
 Area: 4.41 m<sup>2</sup>  
 Perimeter: 8.40 m

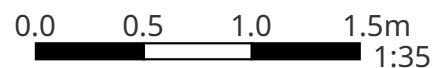
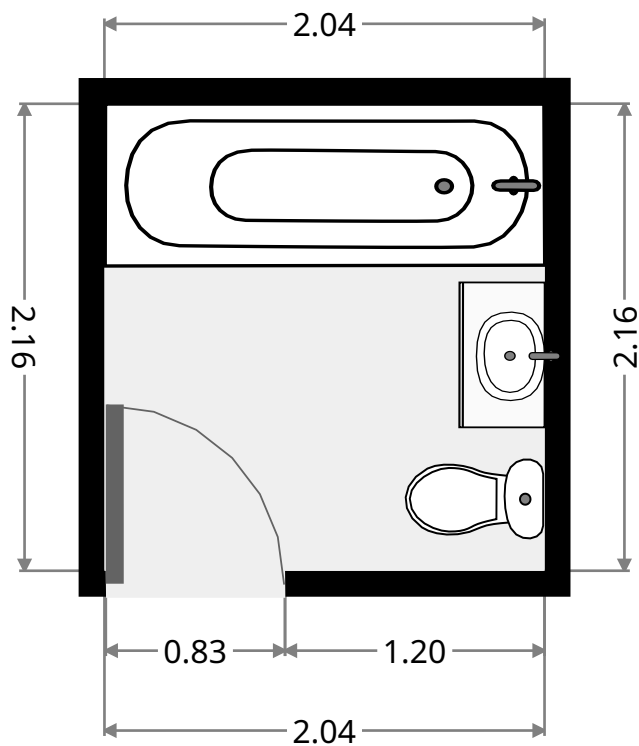
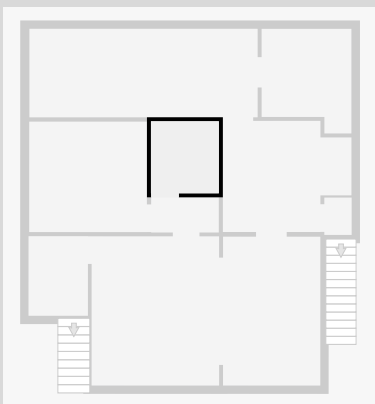

THIS FLOORPLAN IS PROVIDED WITHOUT WARRANTY OF ANY KIND. SENSOPIA DISCLAIMS ANY WARRANTY INCLUDING, WITHOUT LIMITATION, SATISFACTORY QUALITY OR ACCURACY OF DIMENSIONS.



# 253 Denham Street extended

•  
 Width: 1.79 m  
 Length: 2.39 m  
 Area: 4.26 m<sup>2</sup>  
 Perimeter: 8.35 m

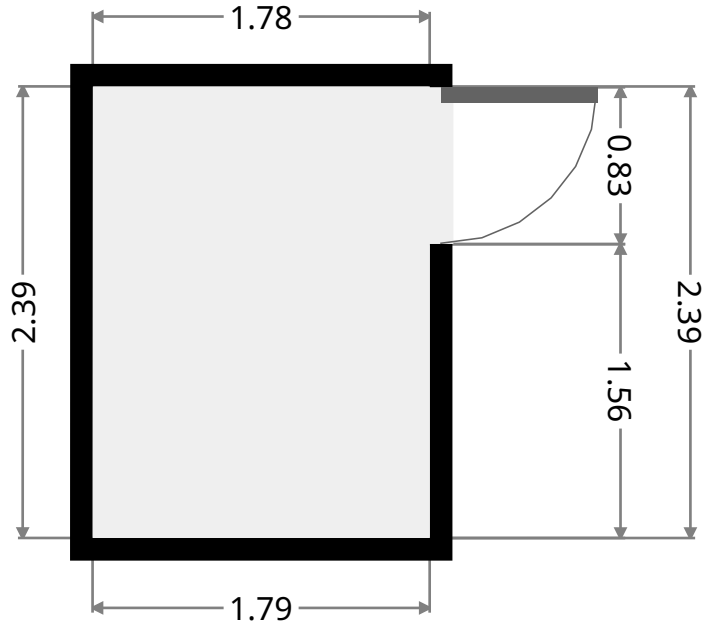
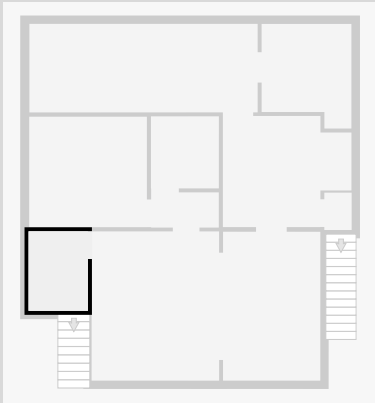

## Verandah

Width: 2.70 m  
 Length: 3.14 m  
 Area: 7.53 m<sup>2</sup>  
 Perimeter: 11.67 m

