

252 Rockonia Road

Created on
2021-06-01

Floors
2

▼ Ground Floor

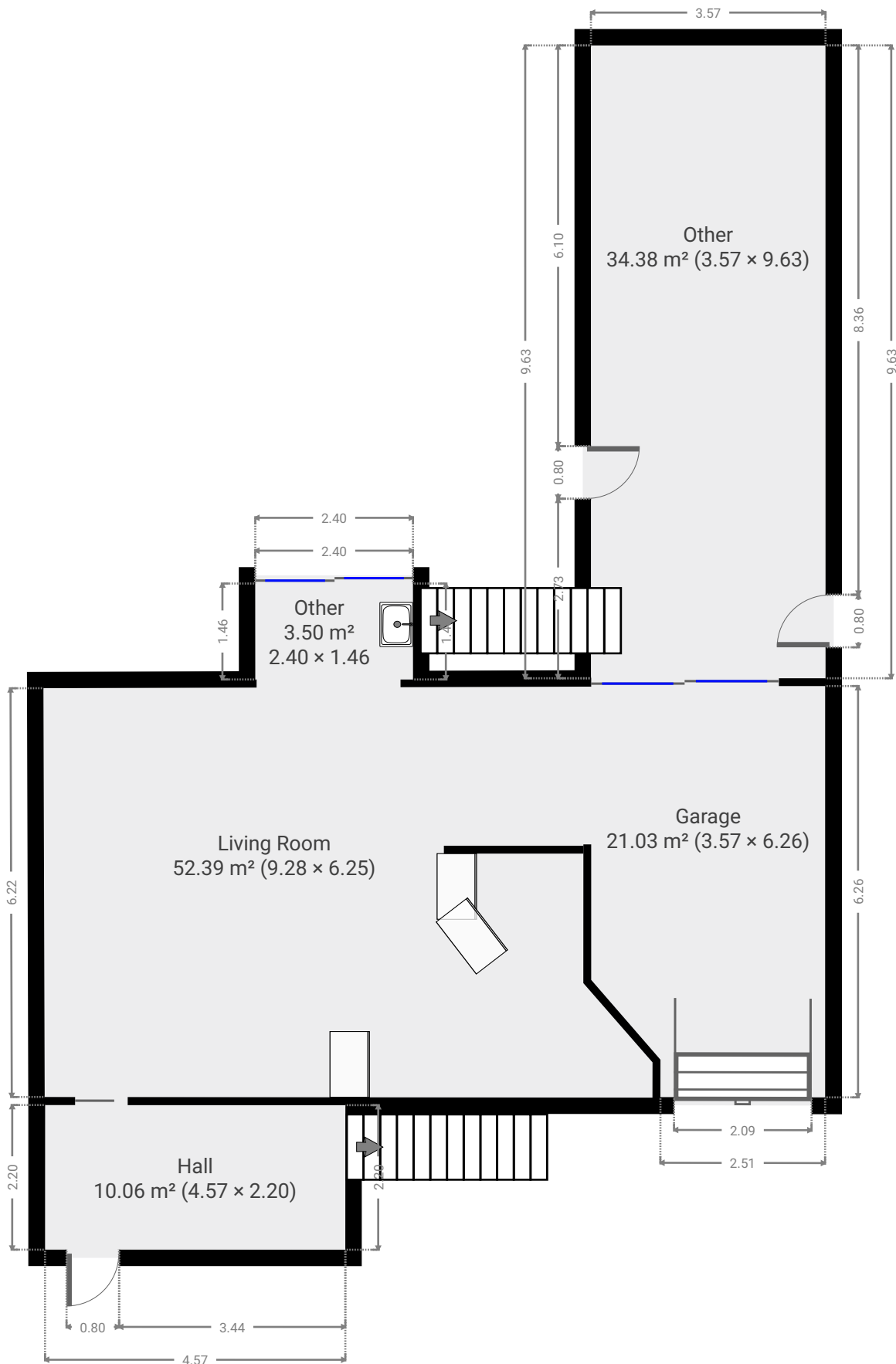

▼ **Hall**
Ground Floor

WIDTH: 4.57 m • LENGTH: 2.20 m
AREA: 10.06 m² • PERIMETER: 13.54 m

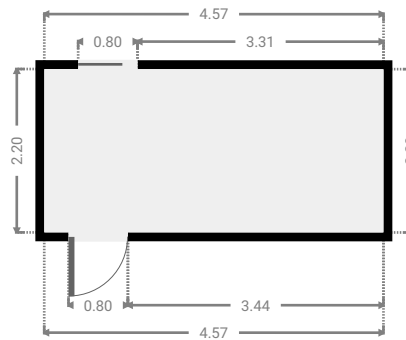
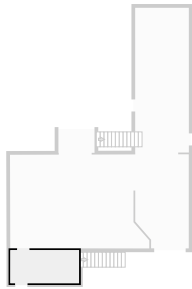

▼ **Living Room**
Ground Floor

WIDTH: 9.28 m • LENGTH: 6.29 m
AREA: 52.39 m² • PERIMETER: 30.34 m

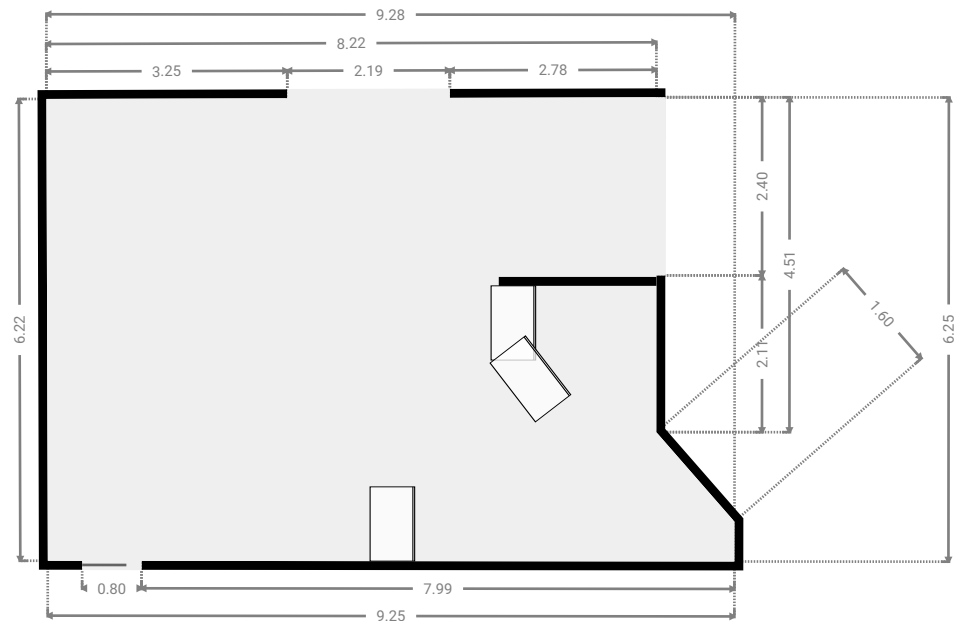
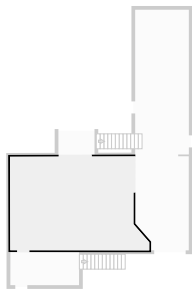

▼ Other
Ground Floor

WIDTH: 2.40 m • LENGTH: 1.46 m
AREA: 3.50 m² • PERIMETER: 7.72 m

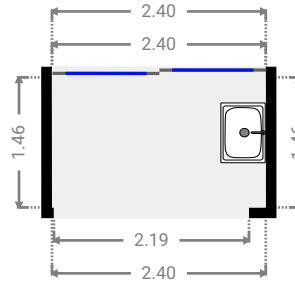
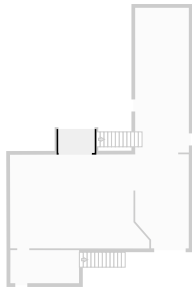

▼ Garage
Ground Floor

WIDTH: 3.48 m • LENGTH: 6.30 m
AREA: 21.03 m² • PERIMETER: 18.97 m

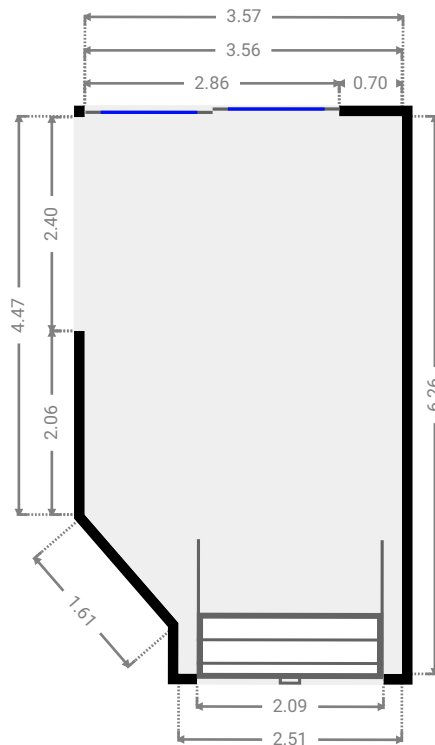
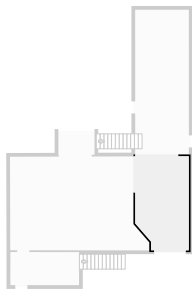

▼ Other
Ground Floor

WIDTH: 3.57 m • LENGTH: 9.63 m
AREA: 34.38 m² • PERIMETER: 26.40 m

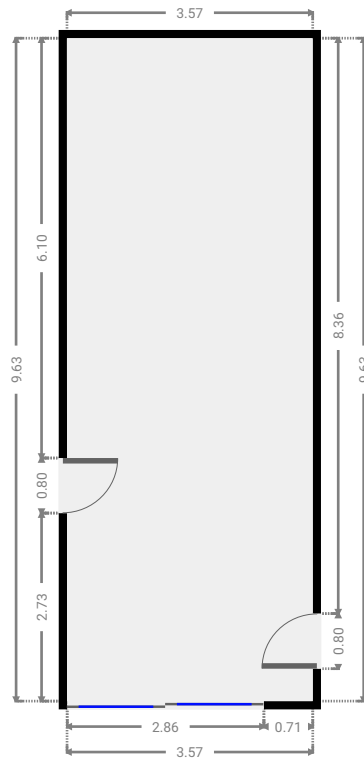
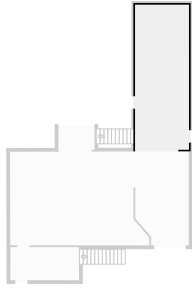

▼ 1st Floor



▼ Living Room
1st Floor

WIDTH: 4.56 m • LENGTH: 2.04 m
AREA: 9.30 m² • PERIMETER: 13.20 m

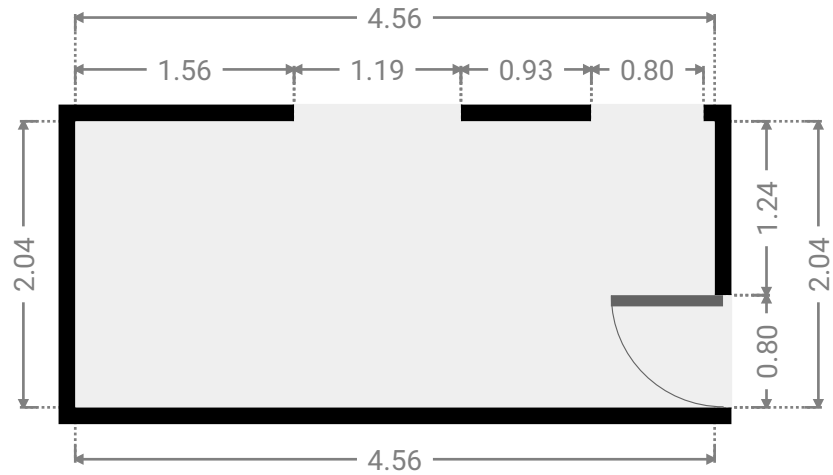
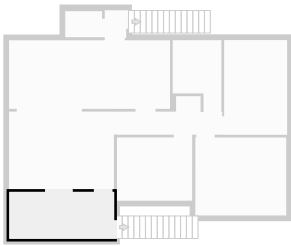

▼ Living Room
1st Floor

WIDTH: 4.56 m • LENGTH: 3.37 m
AREA: 15.37 m² • PERIMETER: 15.86 m

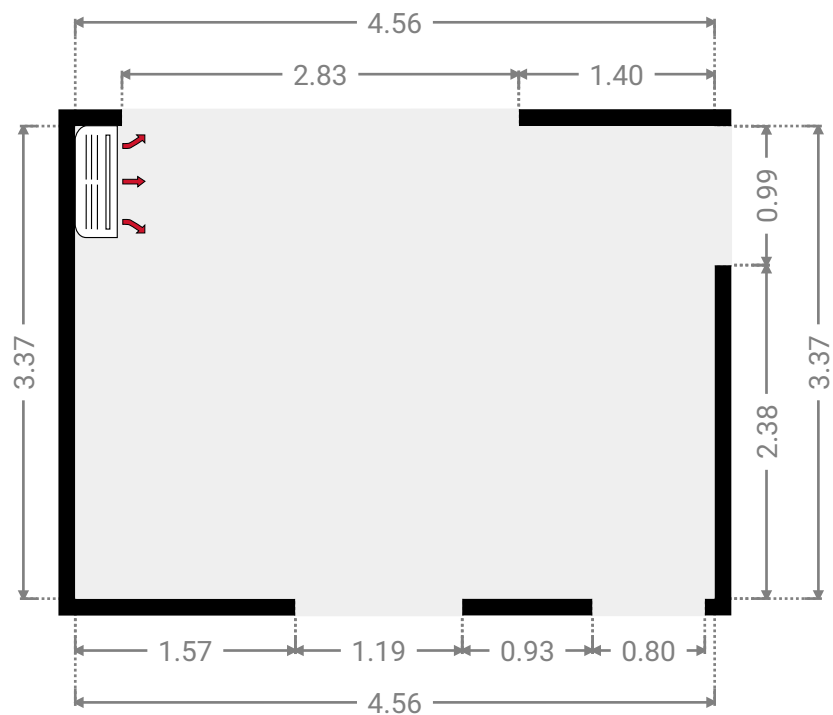
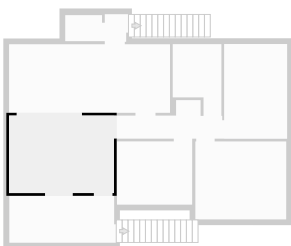

▼ Hall
1st Floor

WIDTH: 4.60 m • LENGTH: 1.67 m
AREA: 5.31 m² • PERIMETER: 12.55 m

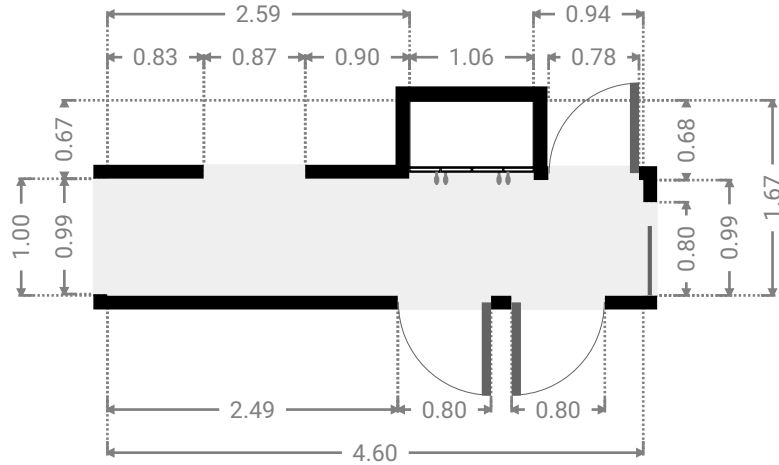
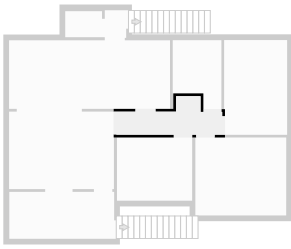

▼ Kitchen
1st Floor

WIDTH: 7.00 m • LENGTH: 2.98 m
AREA: 20.86 m² • PERIMETER: 19.96 m

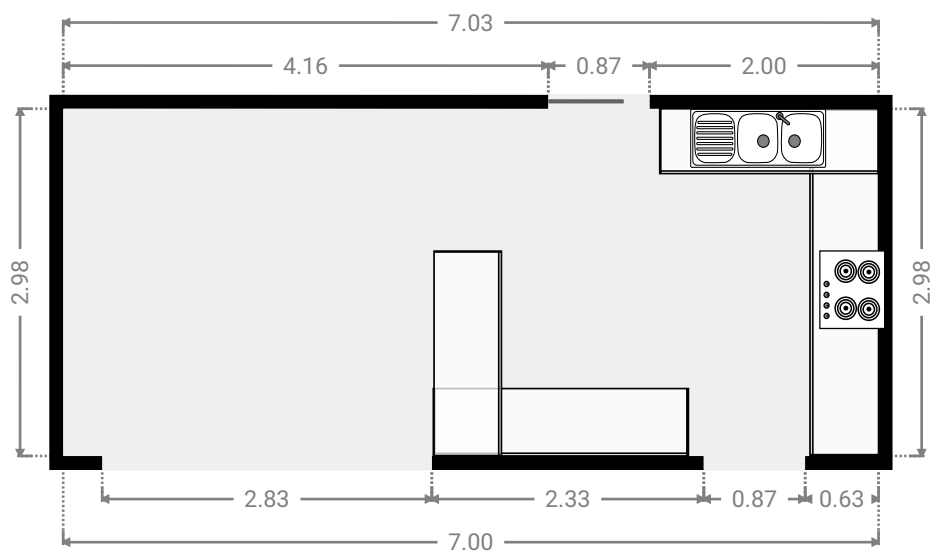
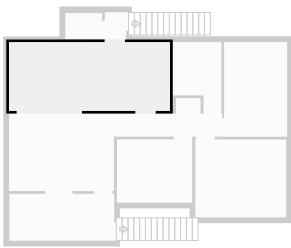

▼ **Hall**
1st Floor

WIDTH: 0.93 m • LENGTH: 1.20 m
AREA: 1.12 m² • PERIMETER: 4.26 m

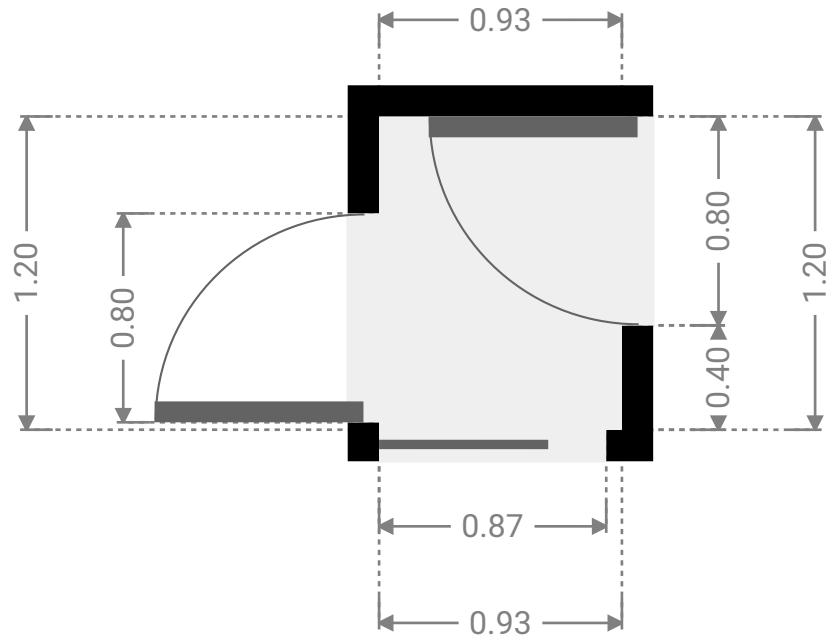
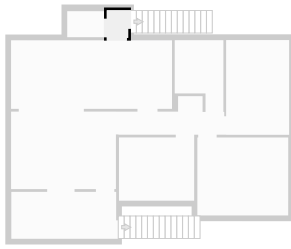

▼ **Toilet**
1st Floor

WIDTH: 1.60 m • LENGTH: 1.13 m
AREA: 1.81 m² • PERIMETER: 5.46 m

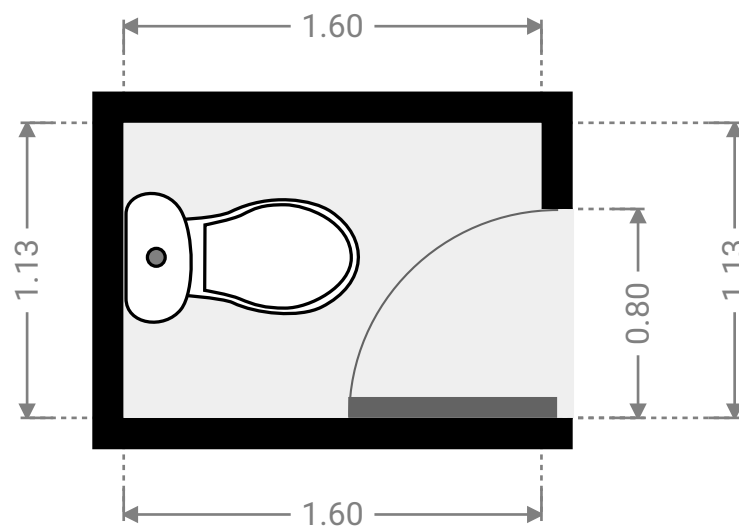
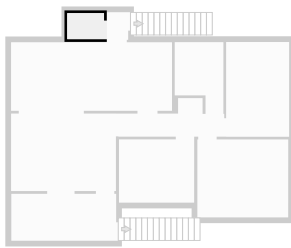

▼ **Bedroom**
1st Floor

WIDTH: 3.27 m • LENGTH: 2.75 m
AREA: 8.99 m² • PERIMETER: 12.04 m

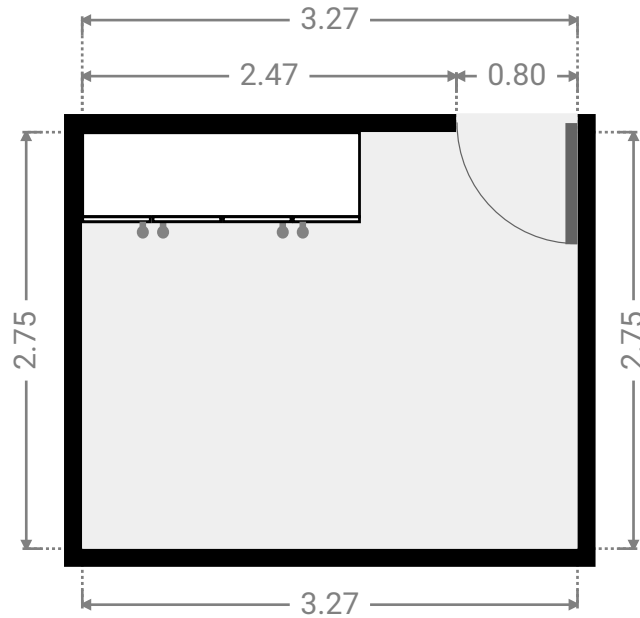
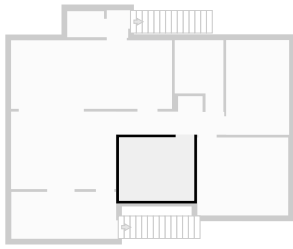

▼ **Master Bedroom**
1st Floor

WIDTH: 3.95 m • LENGTH: 3.39 m
AREA: 13.39 m² • PERIMETER: 14.68 m

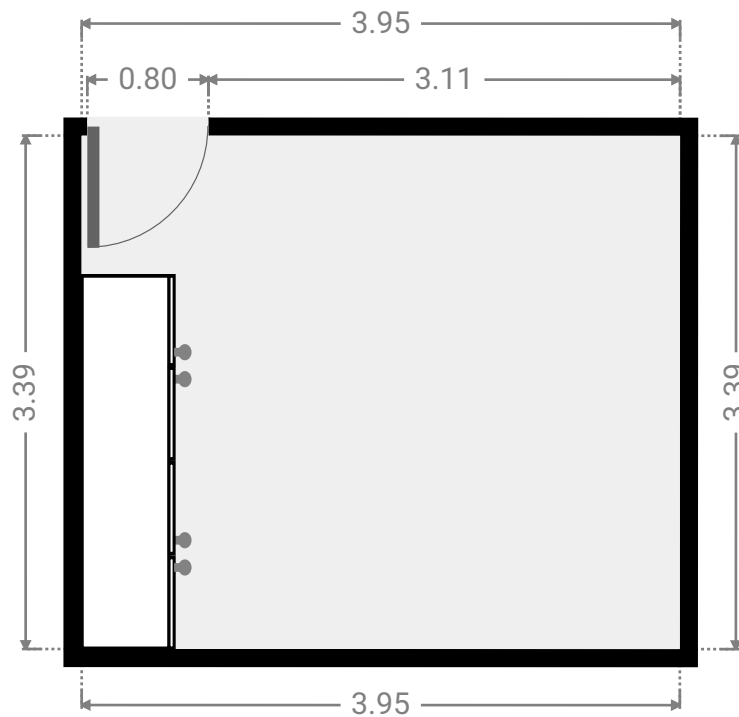
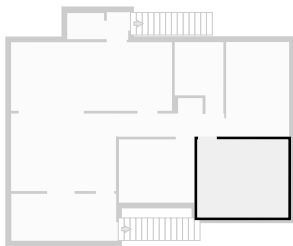

▼ **Bedroom**
1st Floor

WIDTH: 2.74 m • LENGTH: 4.12 m
AREA: 11.29 m² • PERIMETER: 13.72 m

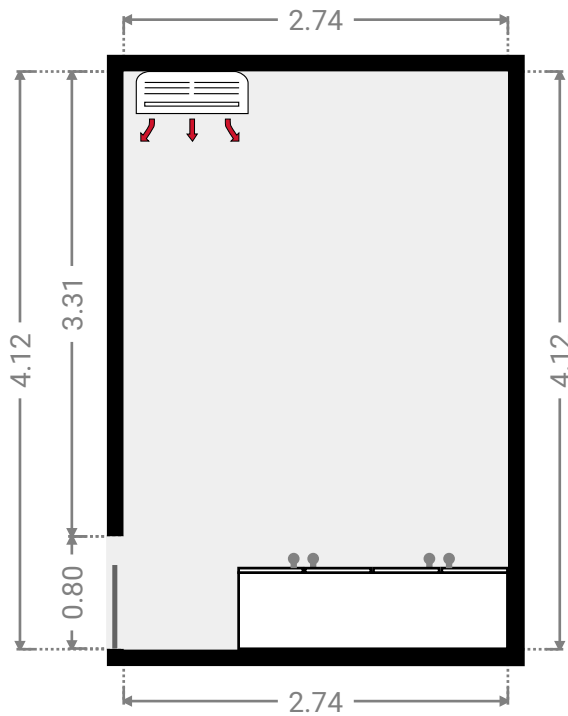
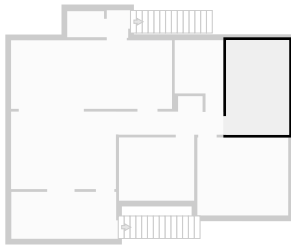

▼ **Bathroom**
1st Floor

WIDTH: 2.12 m • LENGTH: 2.99 m
AREA: 5.42 m² • PERIMETER: 10.21 m

