

# 251 Boyd Street

## Ground Floor

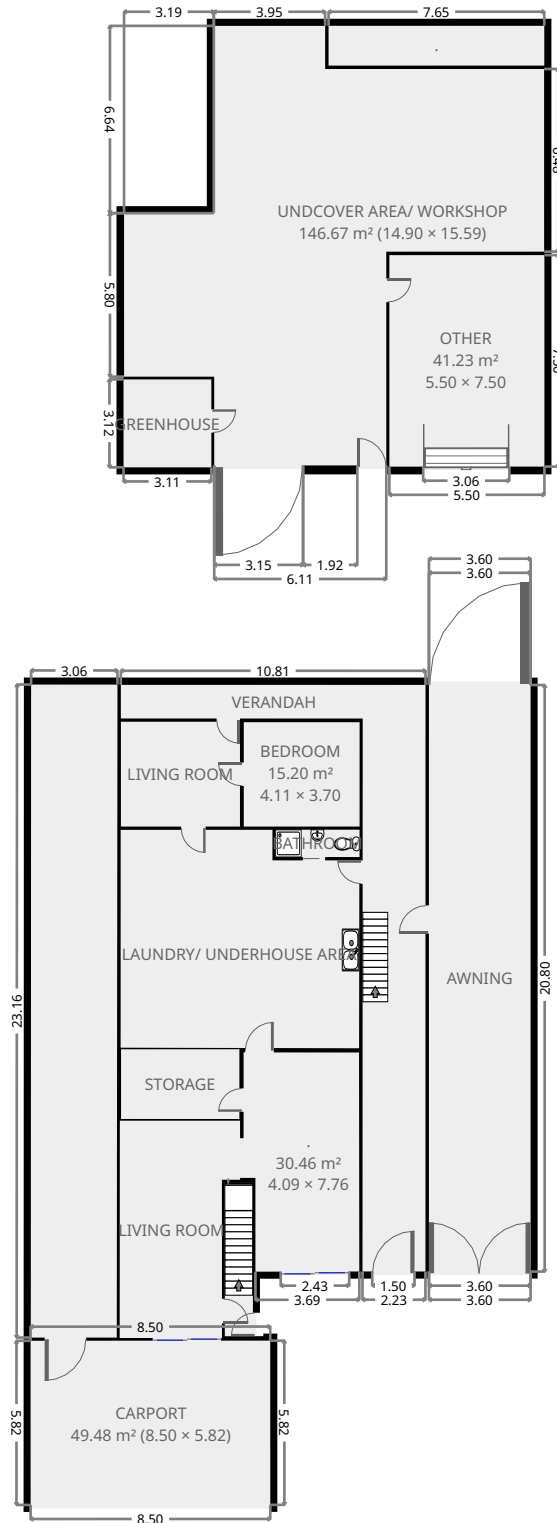

THIS FLOORPLAN IS PROVIDED WITHOUT WARRANTY OF ANY KIND. SENSOPIA DISCLAIMS ANY WARRANTY INCLUDING, WITHOUT LIMITATION, SATISFACTORY QUALITY OR ACCURACY OF DIMENSIONS.



# 251 Boyd Street

•  
 Width: 4.09 m  
 Length: 7.76 m  
 Area: 30.46 m<sup>2</sup>  
 Perimeter: 23.74 m

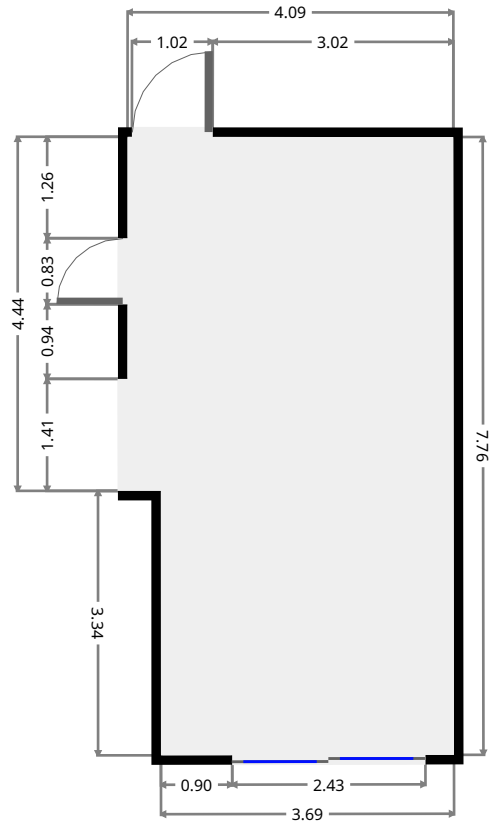
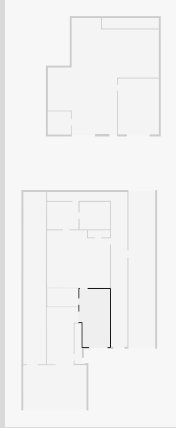

## Living Room

Width: 4.27 m  
 Length: 7.71 m  
 Area: 29.27 m<sup>2</sup>  
 Perimeter: 23.95 m

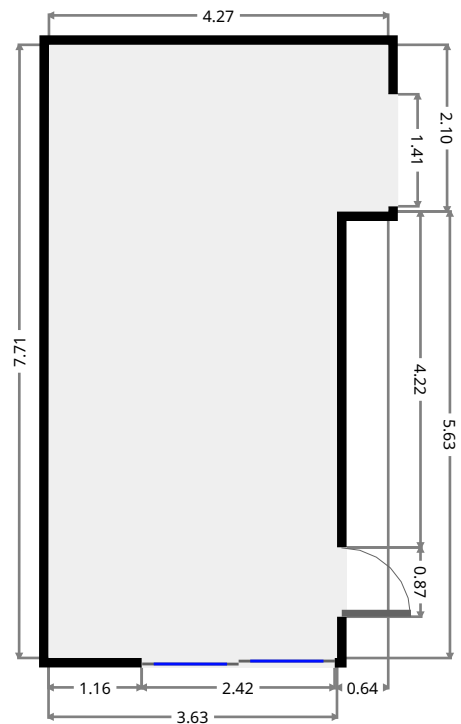
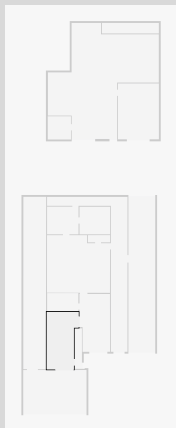

# 251 Boyd Street

## Stairway

Width: 0.99 m  
Length: 5.43 m  
Area: 5.41 m<sup>2</sup>  
Perimeter: 12.86 m

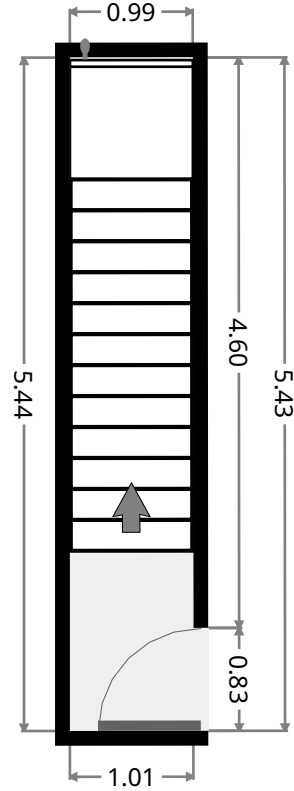
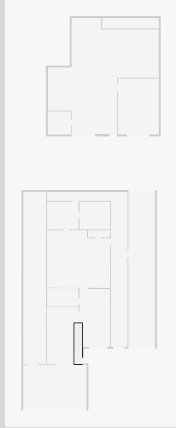

## Storage

Width: 2.49 m  
Length: 4.20 m  
Area: 10.37 m<sup>2</sup>  
Perimeter: 13.34 m

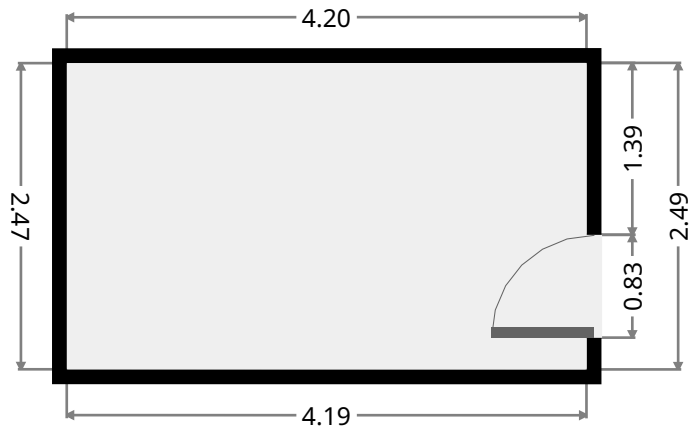
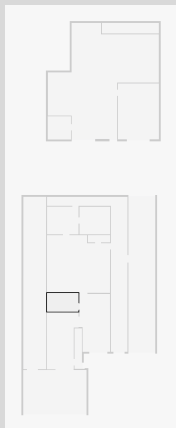

# 251 Boyd Street

## Laundry/ Underhouse Area

Width: 7.74 m  
 Length: 8.48 m  
 Area: 62.11 m<sup>2</sup>  
 Perimeter: 32.39 m

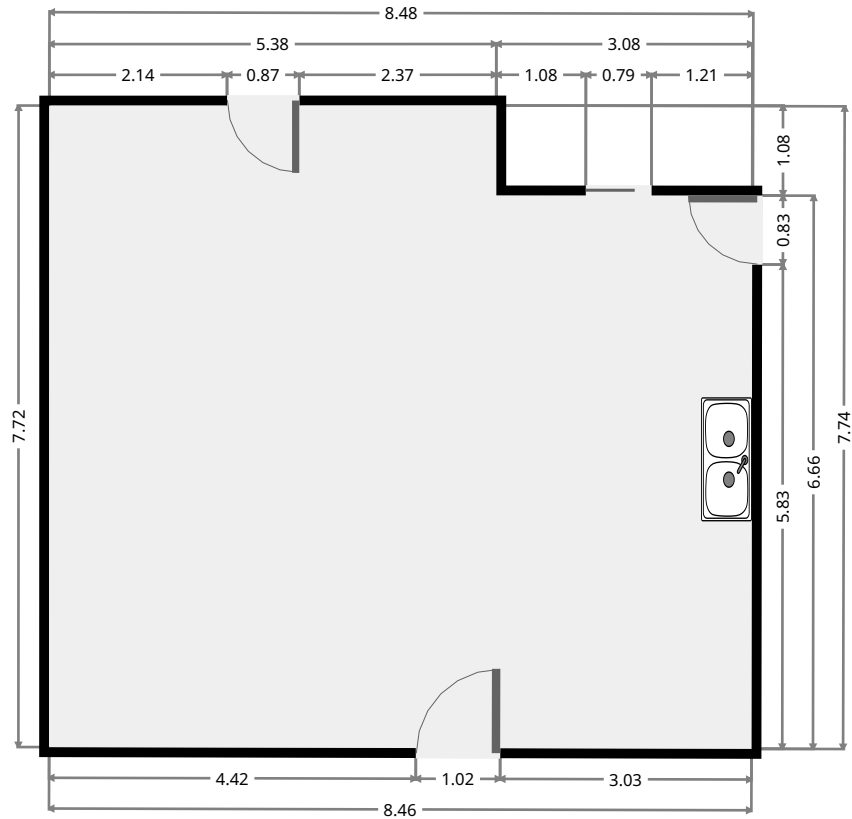
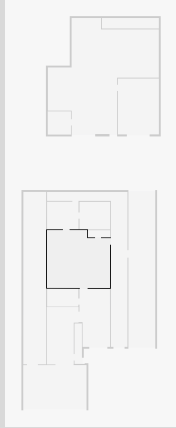

## Bathroom

Width: 0.97 m  
 Length: 2.98 m  
 Area: 2.88 m<sup>2</sup>  
 Perimeter: 7.89 m

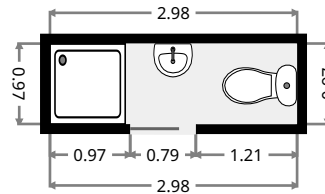
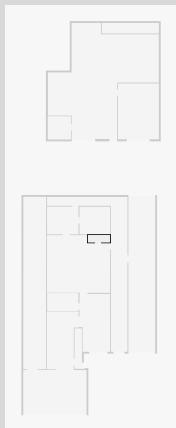

THIS FLOORPLAN IS PROVIDED WITHOUT WARRANTY OF ANY KIND. SENSOPIA DISCLAIMS ANY WARRANTY INCLUDING, WITHOUT LIMITATION, SATISFACTORY QUALITY OR ACCURACY OF DIMENSIONS.



# 251 Boyd Street

## Living Room

Width: 3.72 m  
 Length: 4.22 m  
 Area: 15.69 m<sup>2</sup>  
 Perimeter: 15.88 m

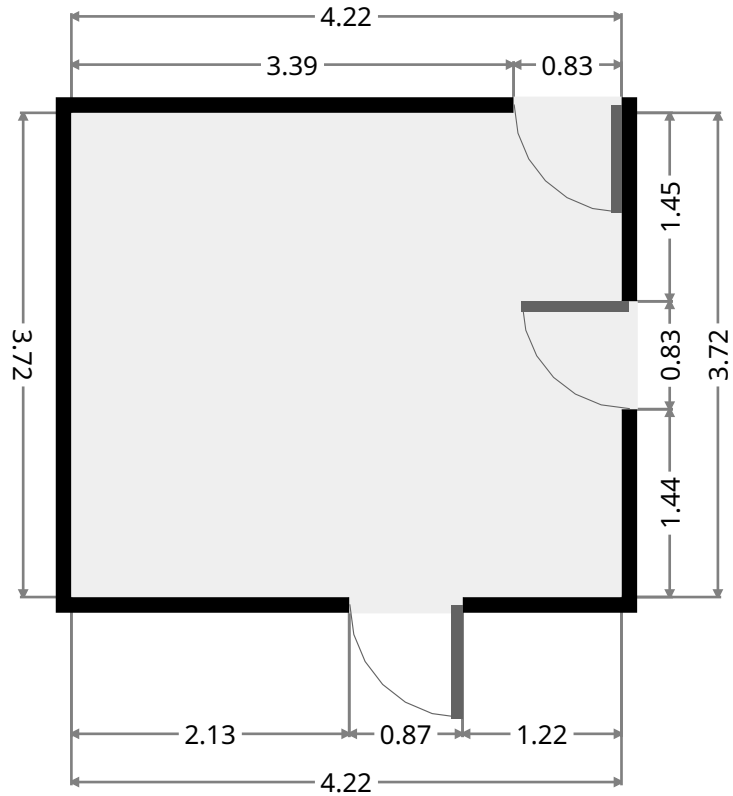
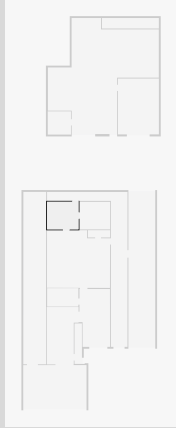

## Bedroom

Width: 3.70 m  
 Length: 4.11 m  
 Area: 15.20 m<sup>2</sup>  
 Perimeter: 15.61 m

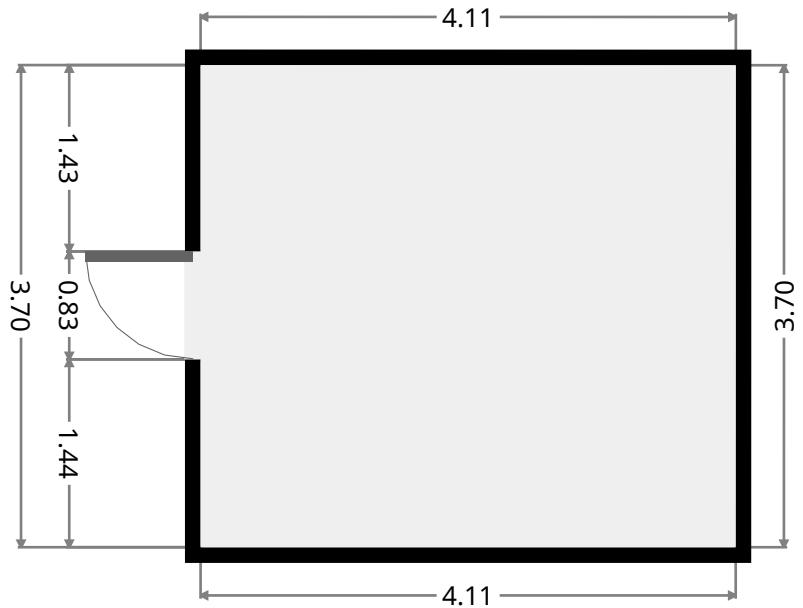
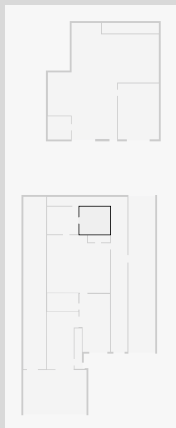

# 251 Boyd Street

## Carport

Width: 5.82 m  
Length: 8.50 m  
Area: 49.48 m<sup>2</sup>  
Perimeter: 28.64 m

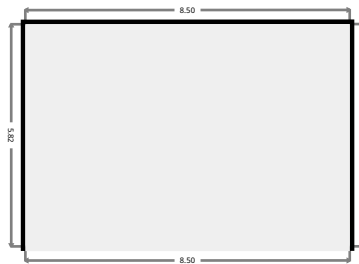
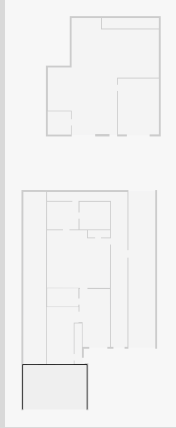

## Verandah

Width: 10.81 m  
Length: 20.80 m  
Area: 56.59 m<sup>2</sup>  
Perimeter: 63.22 m

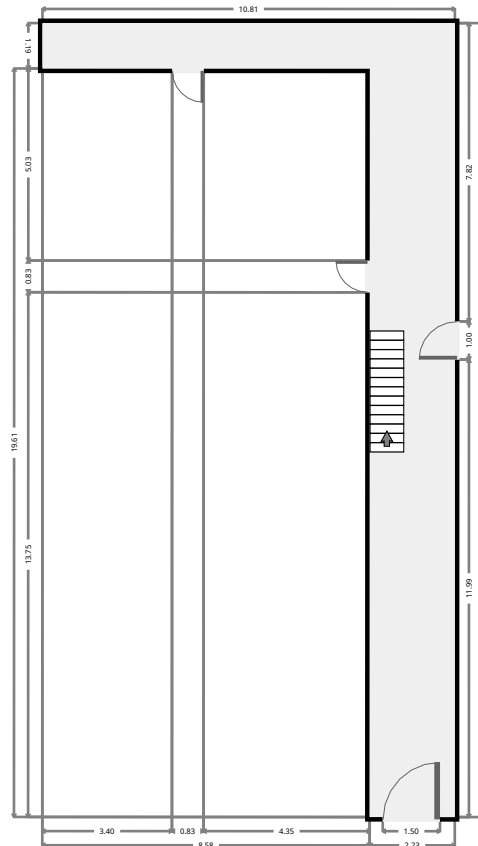
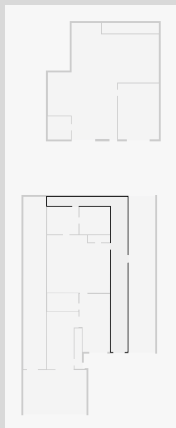

THIS FLOORPLAN IS PROVIDED WITHOUT WARRANTY OF ANY KIND. SENSOPIA DISCLAIMS ANY WARRANTY INCLUDING, WITHOUT LIMITATION, SATISFACTORY QUALITY OR ACCURACY OF DIMENSIONS.

# 251 Boyd Street

## Awning

Width: 3.60 m  
Length: 20.80 m  
Area: 74.96 m<sup>2</sup>  
Perimeter: 48.81 m

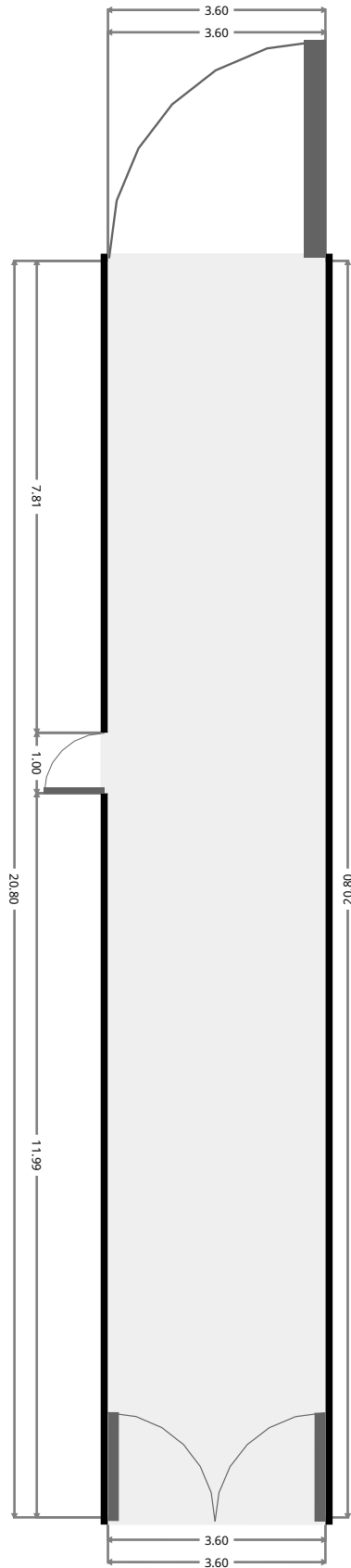
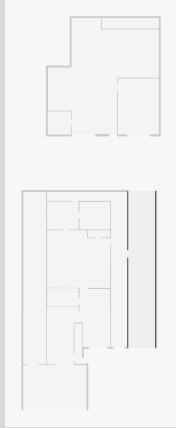

THIS FLOORPLAN IS PROVIDED WITHOUT WARRANTY OF ANY KIND. SENSOPIA DISCLAIMS ANY WARRANTY INCLUDING, WITHOUT LIMITATION, SATISFACTORY QUALITY OR ACCURACY OF DIMENSIONS.

# 251 Boyd Street

## Other

Width: 5.50 m  
 Length: 7.50 m  
 Area: 41.23 m<sup>2</sup>  
 Perimeter: 25.99 m

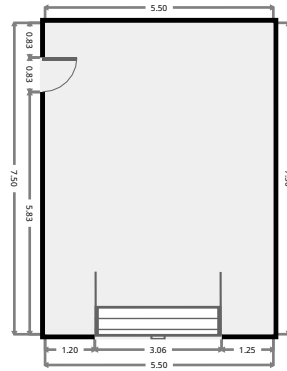
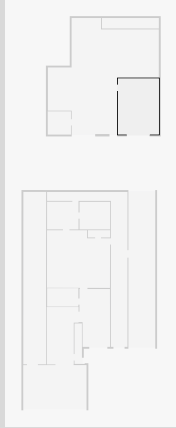

## Undcover Area/ Workshop

Width: 14.90 m  
 Length: 15.59 m  
 Area: 146.67 m<sup>2</sup>  
 Perimeter: 60.97 m

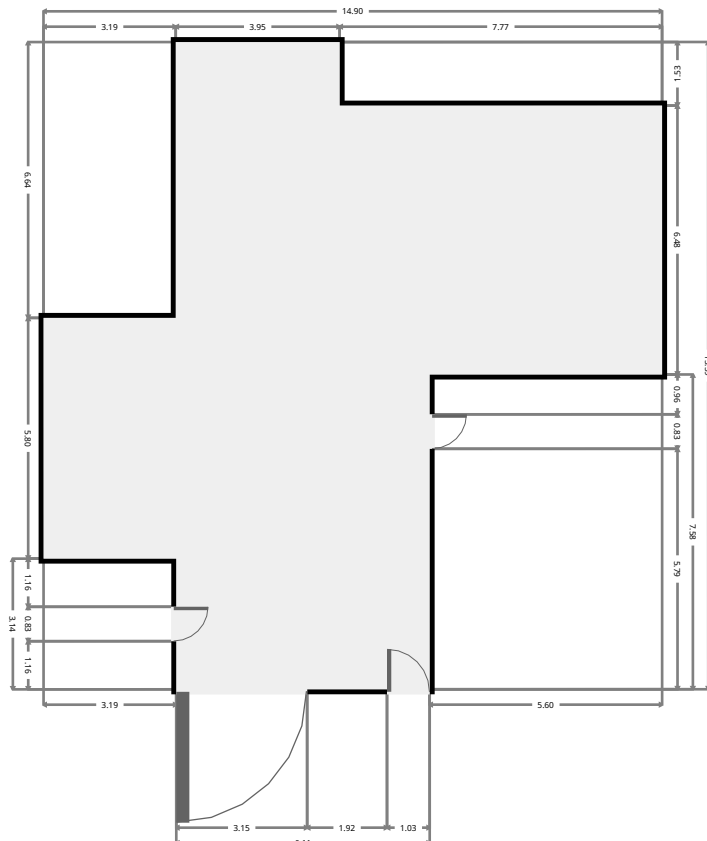
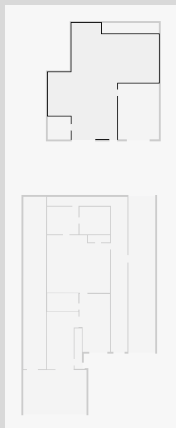

THIS FLOORPLAN IS PROVIDED WITHOUT WARRANTY OF ANY KIND. SENSOPIA DISCLAIMS ANY WARRANTY INCLUDING, WITHOUT LIMITATION, SATISFACTORY QUALITY OR ACCURACY OF DIMENSIONS.



# 251 Boyd Street

## Greenhouse

Width: 3.11 m  
Length: 3.13 m  
Area: 9.71 m<sup>2</sup>  
Perimeter: 12.46 m

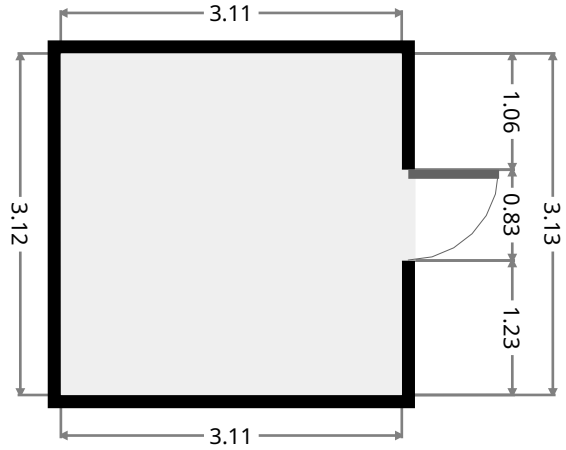
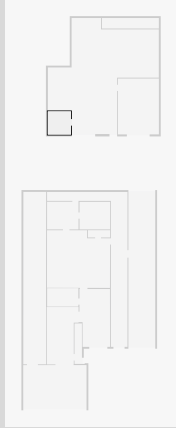

•  
Width: 1.41 m  
Length: 7.65 m  
Area: 10.79 m<sup>2</sup>  
Perimeter: 18.12 m

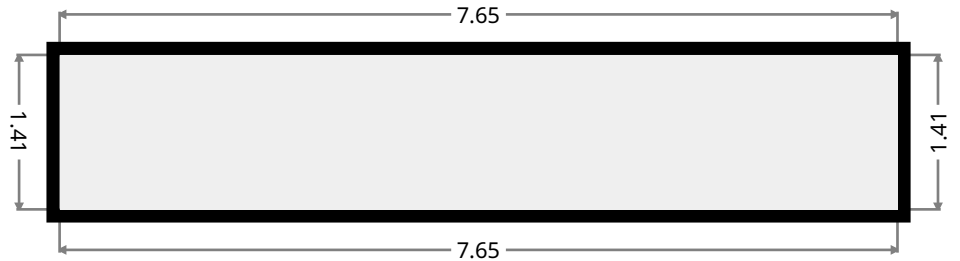
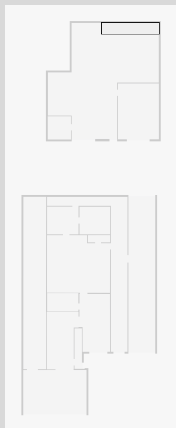

# 251 Boyd Street

## Awning/Greenhouse

Width: 3.06 m  
Length: 23.16 m  
Area: 70.75 m<sup>2</sup>  
Perimeter: 52.42 m

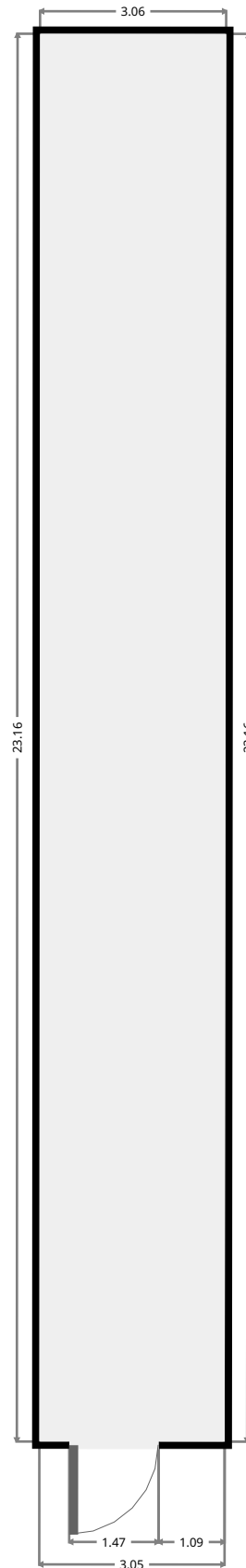
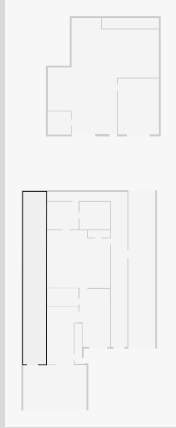

THIS FLOORPLAN IS PROVIDED WITHOUT WARRANTY OF ANY KIND. SENSOPIA DISCLAIMS ANY WARRANTY INCLUDING, WITHOUT LIMITATION, SATISFACTORY QUALITY OR ACCURACY OF DIMENSIONS.

# 251 Boyd Street

## 1st Floor

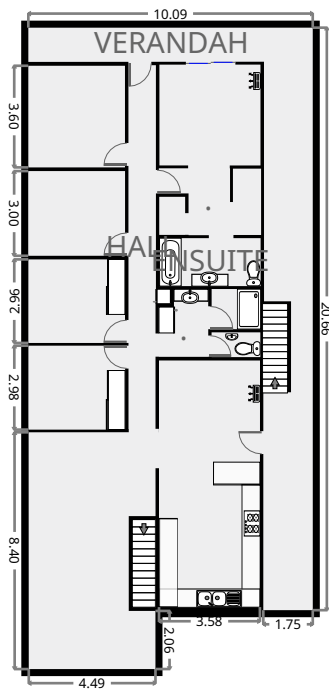

THIS FLOORPLAN IS PROVIDED WITHOUT WARRANTY OF ANY KIND. SENSOPIA DISCLAIMS ANY WARRANTY INCLUDING, WITHOUT LIMITATION, SATISFACTORY QUALITY OR ACCURACY OF DIMENSIONS.



# 251 Boyd Street

## Bedroom

Width: 3.00 m  
Length: 3.43 m  
Area: 10.31 m<sup>2</sup>  
Perimeter: 12.88 m

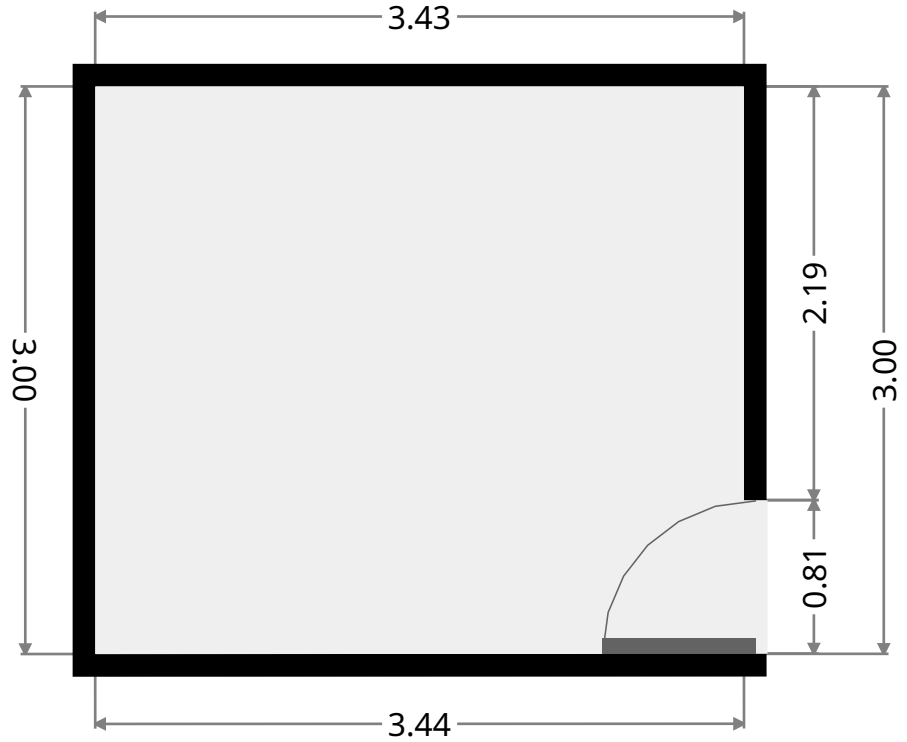
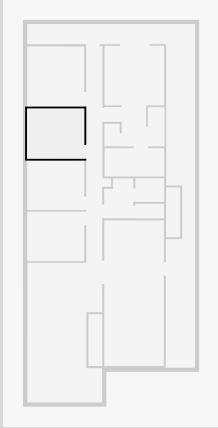

## Stairway

Width: 0.85 m  
Length: 2.99 m  
Area: 2.54 m<sup>2</sup>  
Perimeter: 7.67 m

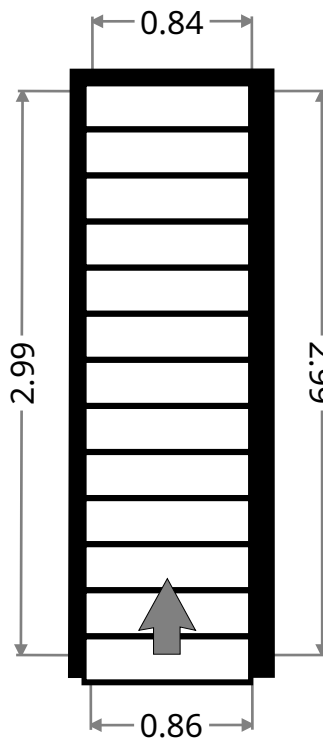
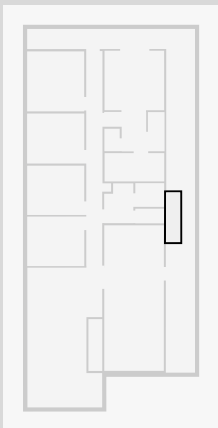

# 251 Boyd Street

## Verandah

Width: 10.09 m  
 Length: 20.66 m  
 Area: 42.91 m<sup>2</sup>  
 Perimeter: 63.46 m

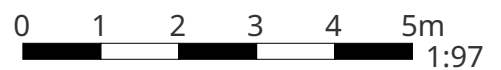
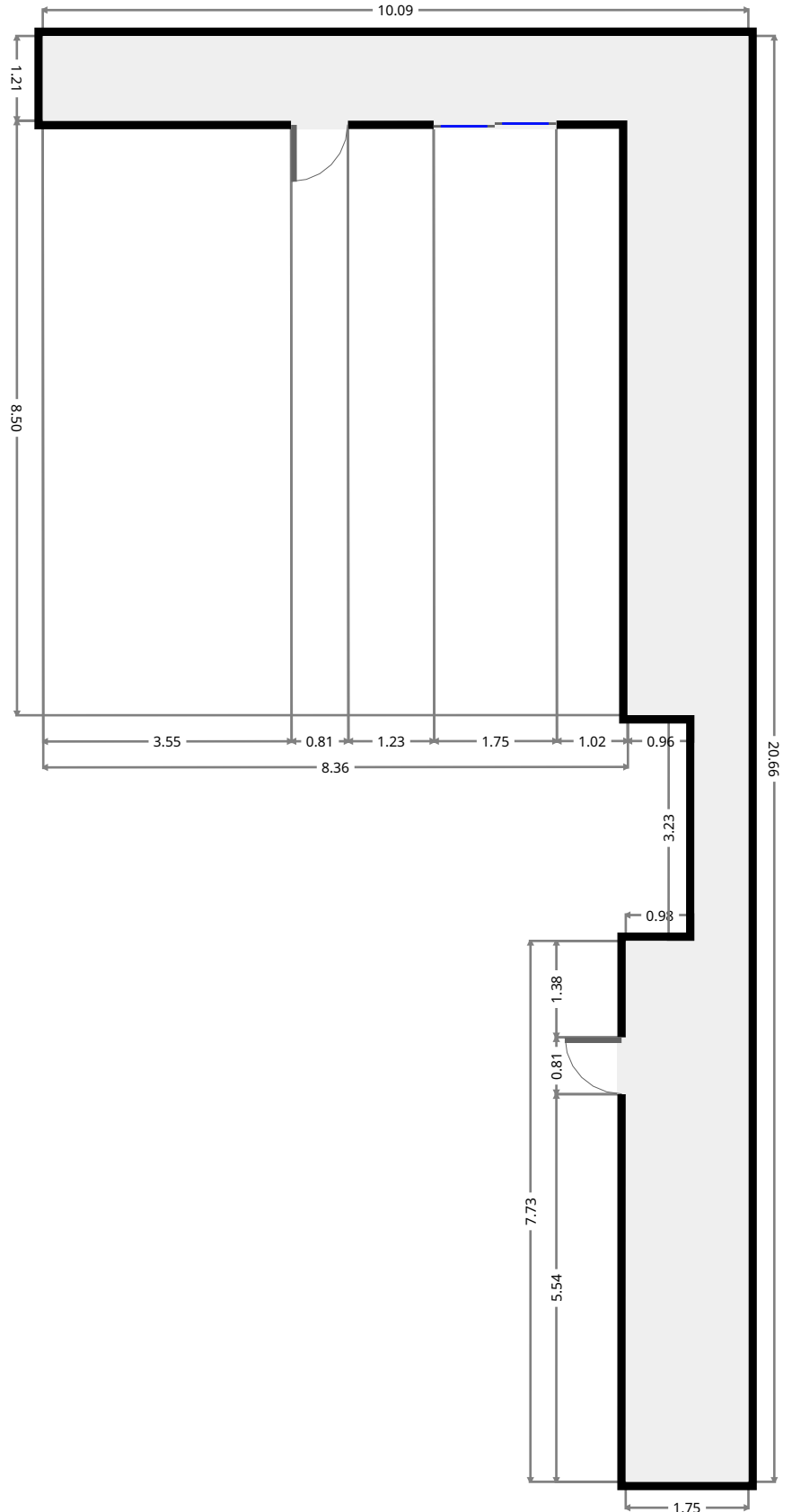
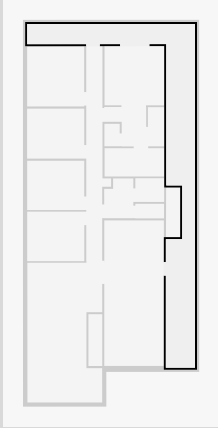

THIS FLOORPLAN IS PROVIDED WITHOUT WARRANTY OF ANY KIND. SENSOPIA DISCLAIMS ANY WARRANTY INCLUDING, WITHOUT LIMITATION, SATISFACTORY QUALITY OR ACCURACY OF DIMENSIONS.

# 251 Boyd Street

## Master Bedroom

Width: 3.58 m  
 Length: 3.59 m  
 Area: 12.81 m<sup>2</sup>  
 Perimeter: 14.32 m

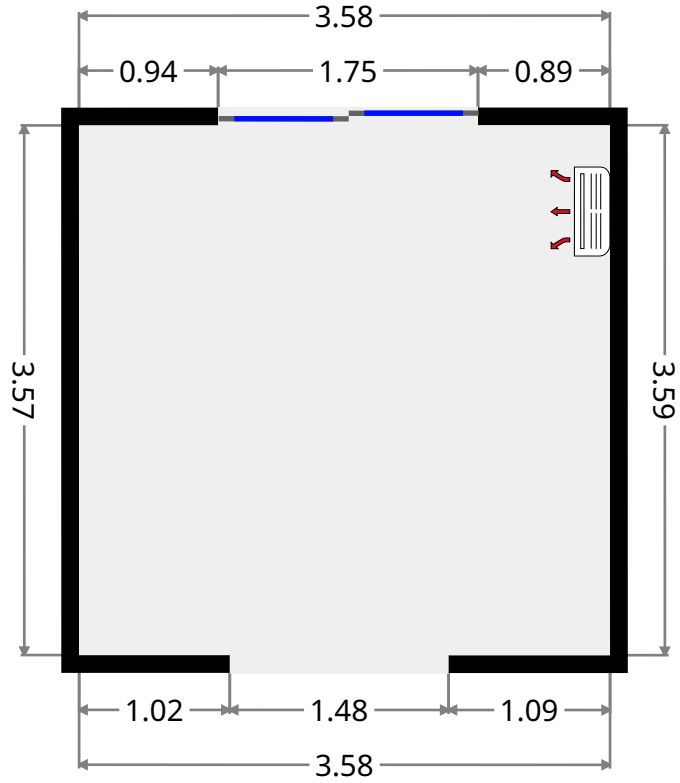
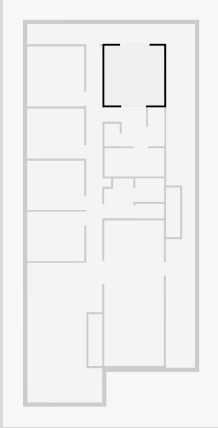

## WIR

Width: 1.00 m  
 Length: 2.35 m  
 Area: 2.35 m<sup>2</sup>  
 Perimeter: 6.70 m

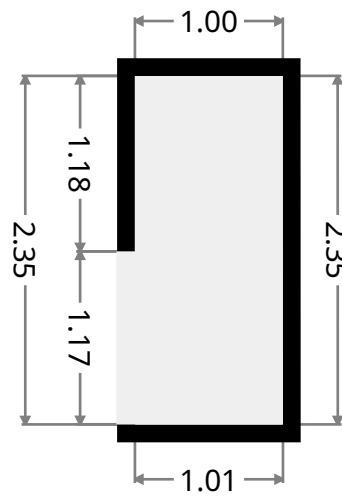
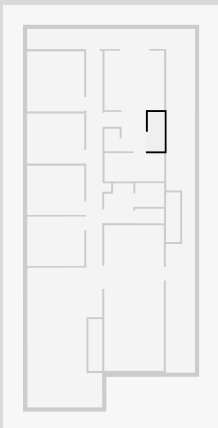

# 251 Boyd Street

## WIR

Width: 0.92 m  
 Length: 1.35 m  
 Area: 1.24 m<sup>2</sup>  
 Perimeter: 4.54 m

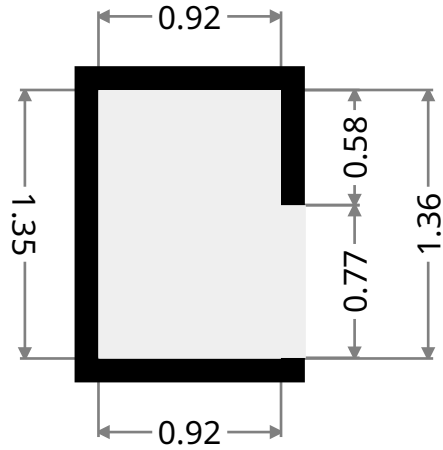
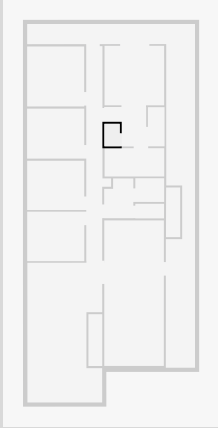

## Ensuite

Width: 1.71 m  
 Length: 3.58 m  
 Area: 6.09 m<sup>2</sup>  
 Perimeter: 10.57 m

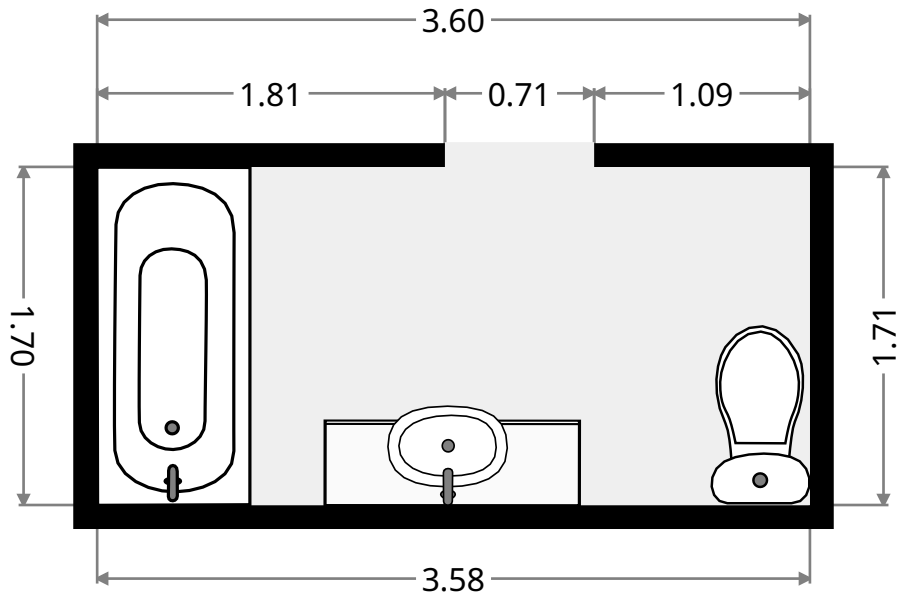
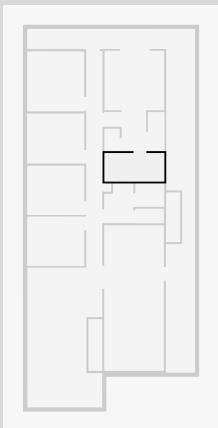

# 251 Boyd Street

•  
 Width: 2.38 m  
 Length: 2.53 m  
 Area: 4.43 m<sup>2</sup>  
 Perimeter: 9.79 m

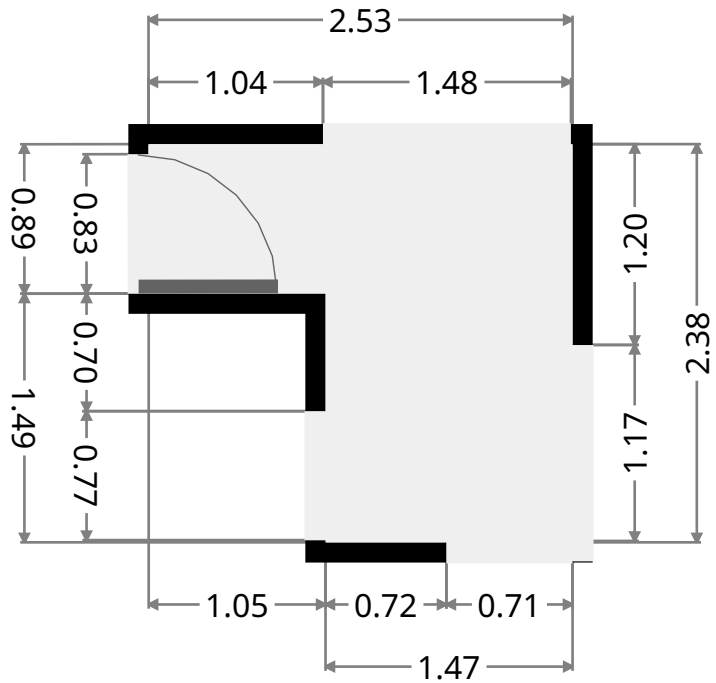
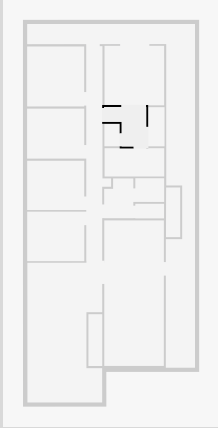

## Bedroom

Width: 3.43 m  
 Length: 3.60 m  
 Area: 12.35 m<sup>2</sup>  
 Perimeter: 14.06 m

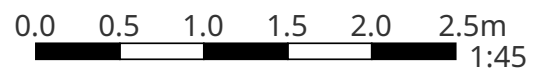
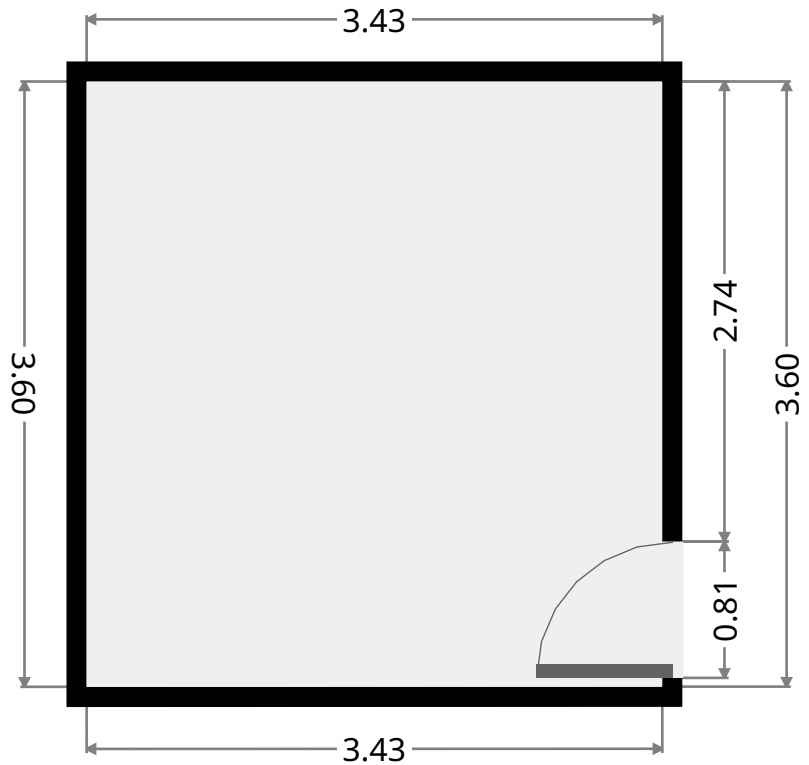
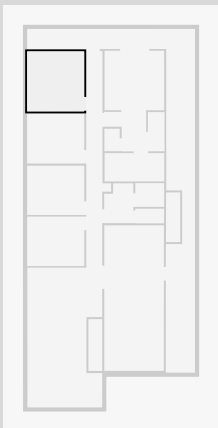

THIS FLOORPLAN IS PROVIDED WITHOUT WARRANTY OF ANY KIND. SENSOPIA DISCLAIMS ANY WARRANTY INCLUDING, WITHOUT LIMITATION, SATISFACTORY QUALITY OR ACCURACY OF DIMENSIONS.



# 251 Boyd Street

## Living Room

Width: 4.50 m  
Length: 8.40 m  
Area: 34.57 m<sup>2</sup>  
Perimeter: 27.68 m

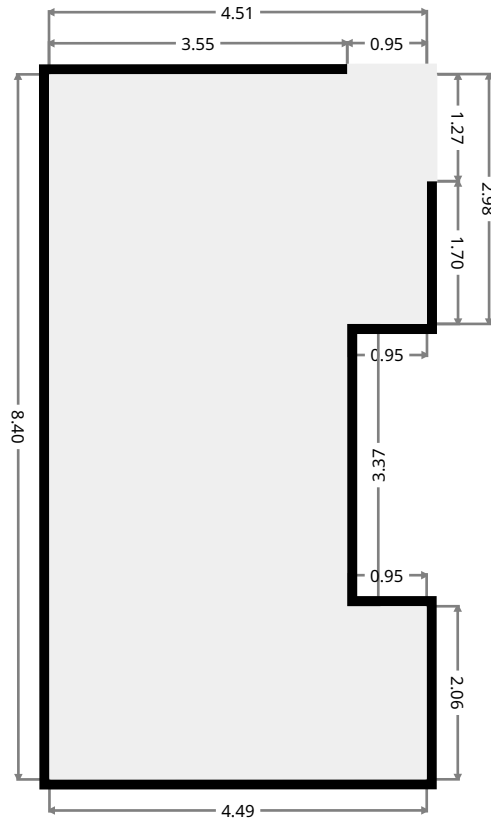
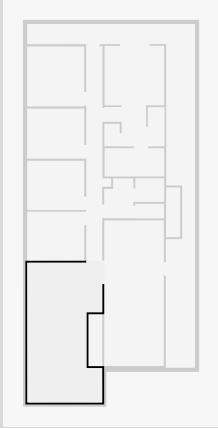

## Bedroom

Width: 2.97 m  
Length: 3.43 m  
Area: 10.16 m<sup>2</sup>  
Perimeter: 12.78 m

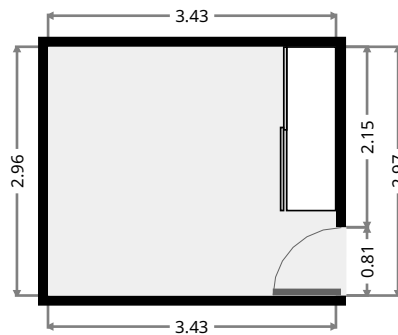
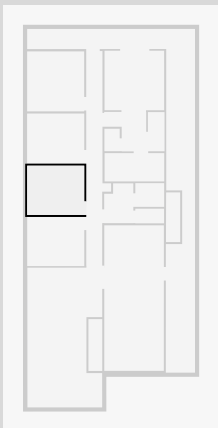

# 251 Boyd Street

## Bathroom

Width: 1.43 m  
Length: 1.73 m  
Area: 2.47 m<sup>2</sup>  
Perimeter: 6.31 m

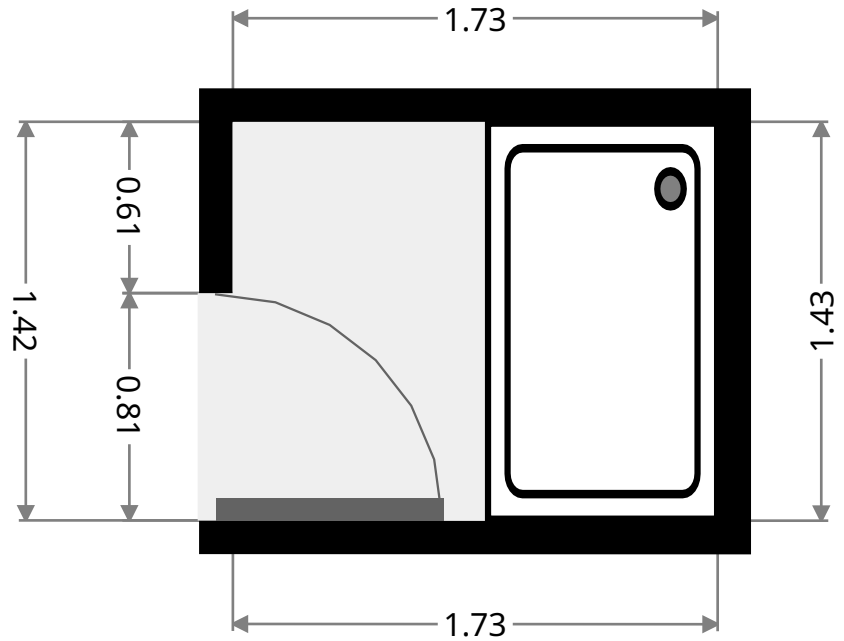
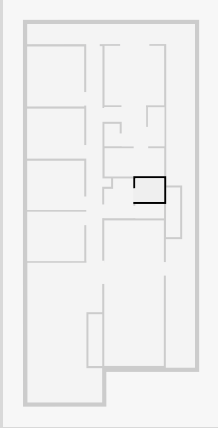

## Toilet

Width: 0.88 m  
Length: 1.73 m  
Area: 1.52 m<sup>2</sup>  
Perimeter: 5.21 m

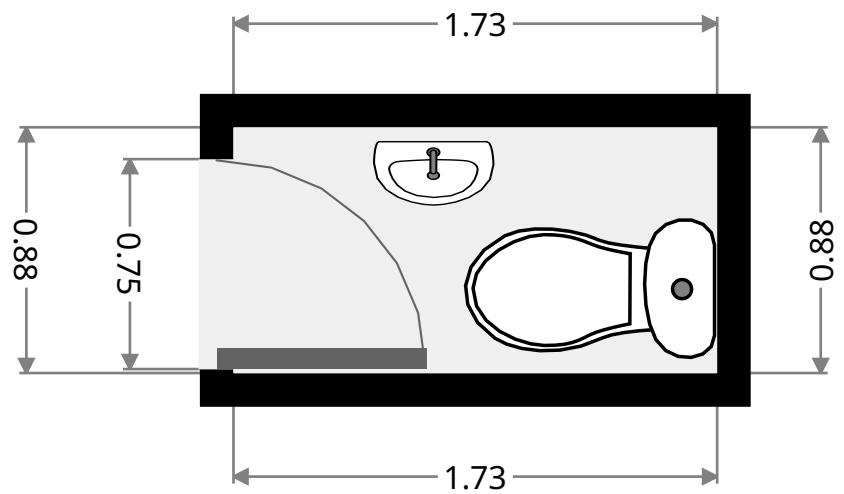
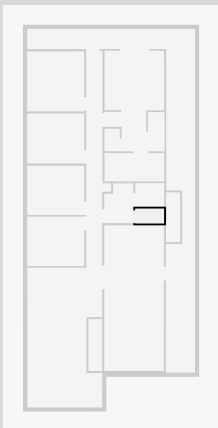

# 251 Boyd Street

Width: 1.75 m  
 Length: 2.39 m  
 Area: 3.85 m<sup>2</sup>  
 Perimeter: 8.28 m

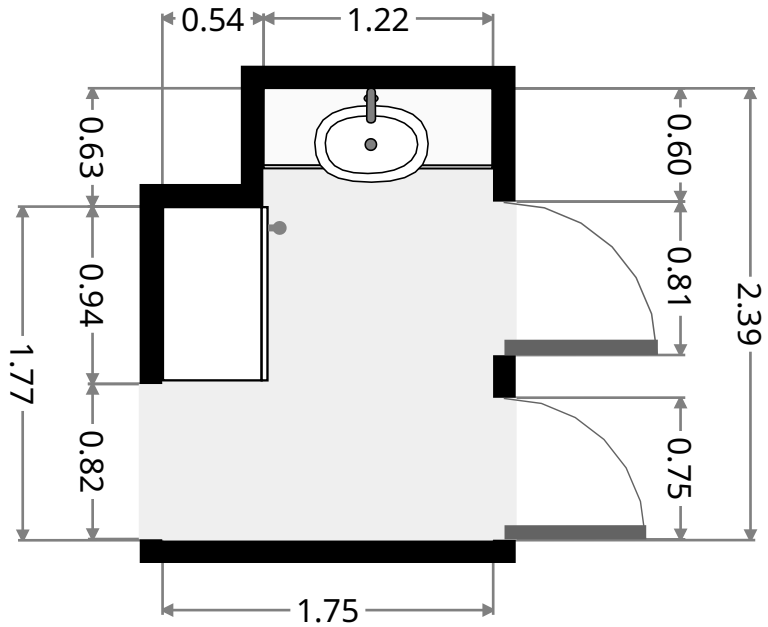
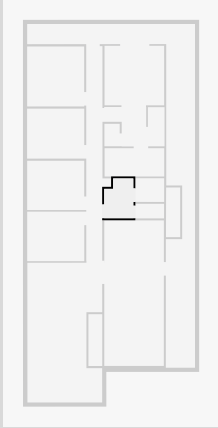

## Bedroom

Width: 2.99 m  
 Length: 3.43 m  
 Area: 10.21 m<sup>2</sup>  
 Perimeter: 12.81 m

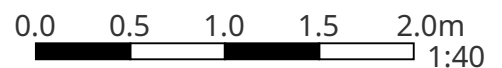
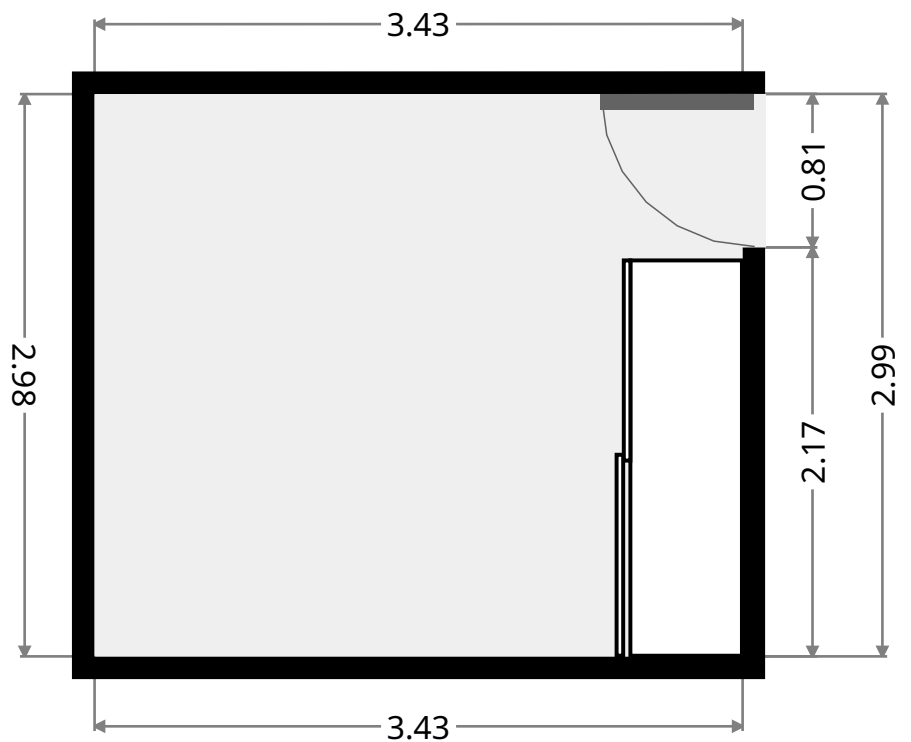
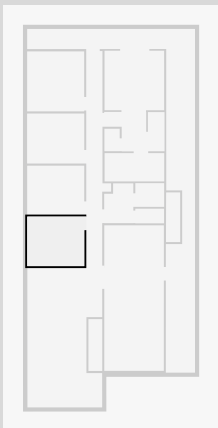

THIS FLOORPLAN IS PROVIDED WITHOUT WARRANTY OF ANY KIND. SENSOPIA DISCLAIMS ANY WARRANTY INCLUDING, WITHOUT LIMITATION, SATISFACTORY QUALITY OR ACCURACY OF DIMENSIONS.

# 251 Boyd Street

## Hall

Width: 1.49 m  
 Length: 12.90 m  
 Area: 12.75 m<sup>2</sup>  
 Perimeter: 28.79 m

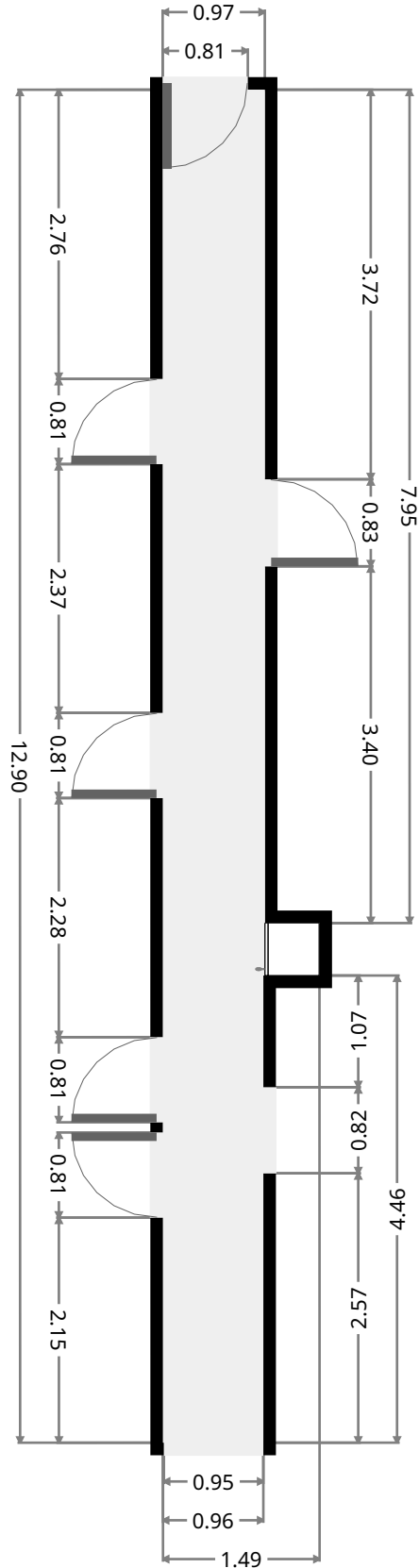
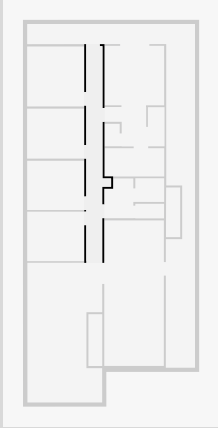

THIS FLOORPLAN IS PROVIDED WITHOUT WARRANTY OF ANY KIND. SENSOPIA DISCLAIMS ANY WARRANTY INCLUDING, WITHOUT LIMITATION, SATISFACTORY QUALITY OR ACCURACY OF DIMENSIONS.

# 251 Boyd Street

## Kitchen/Dining

Width: 3.58 m  
Length: 8.74 m  
Area: 31.31 m<sup>2</sup>  
Perimeter: 24.65 m

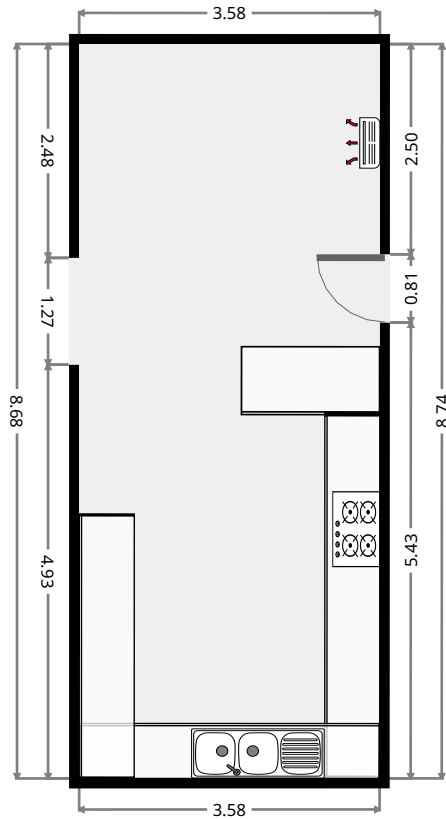
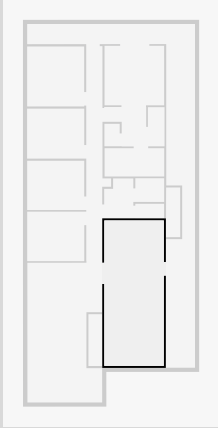

## Stairway

Width: 0.83 m  
Length: 3.11 m  
Area: 2.58 m<sup>2</sup>  
Perimeter: 7.89 m

