

25 Stan Jones

SUBMITTED BY

Ray White Rockhampton Casey
stockers@cqoz.com

CREATED ON

2021-11-08

Floors

1

▼ Ground Floor



▼ Living Room
Ground Floor

WIDTH: 6.69 m • LENGTH: 3.22 m
AREA: 20.11 m² • PERIMETER: 19.30 m

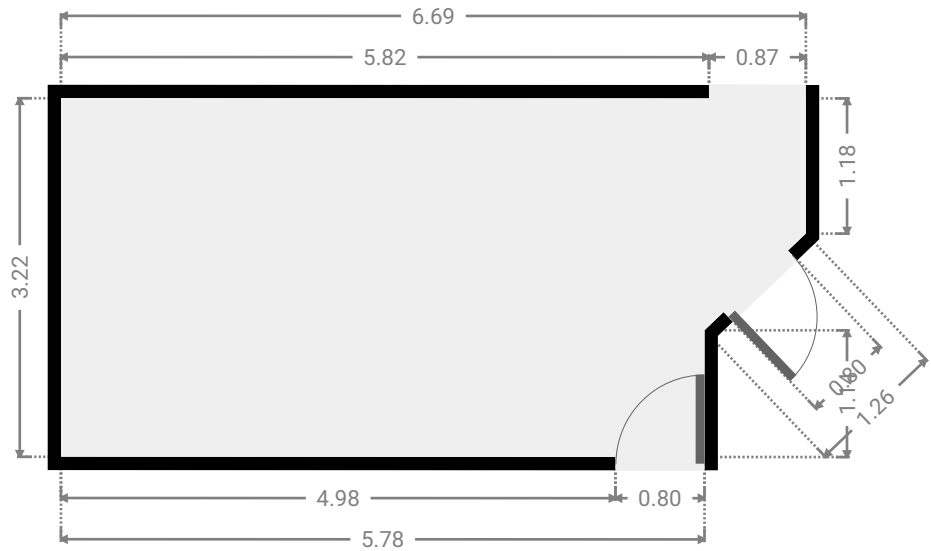
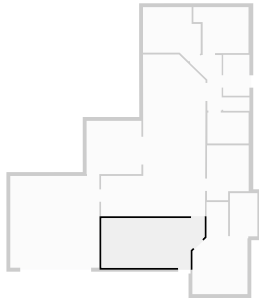

▼ Master Bedroom
Ground Floor

WIDTH: 3.57 m • LENGTH: 3.63 m
AREA: 12.60 m² • PERIMETER: 13.90 m

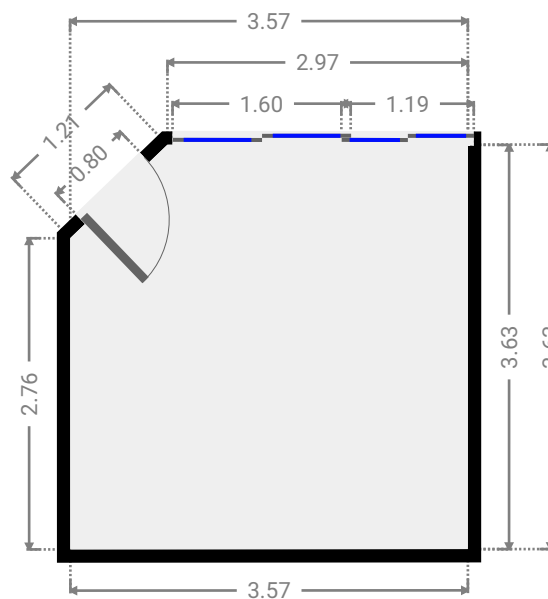
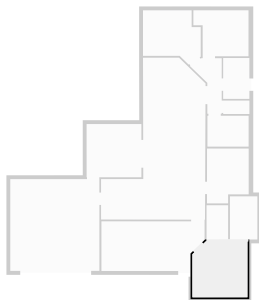

▼ **Closet**
Ground Floor

WIDTH: 1.40 m • LENGTH: 2.22 m
AREA: 3.11 m² • PERIMETER: 7.24 m

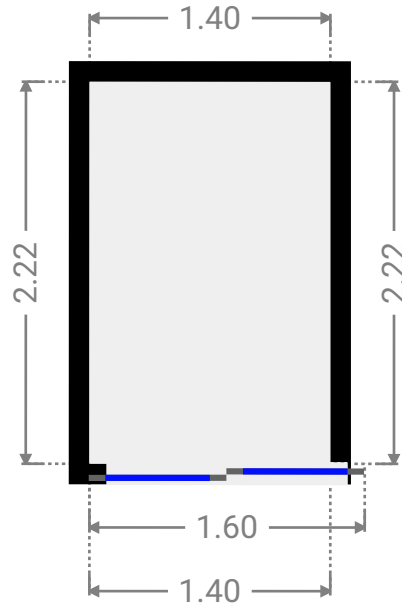
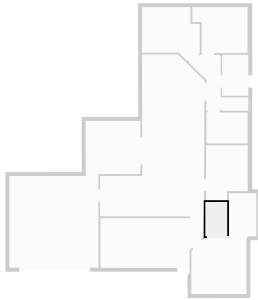

▼ **Bathroom**
Ground Floor

WIDTH: 1.78 m • LENGTH: 2.80 m
AREA: 4.98 m² • PERIMETER: 9.16 m

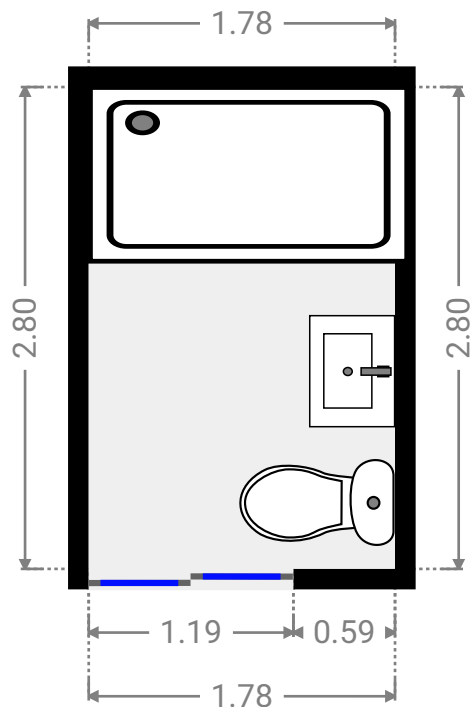
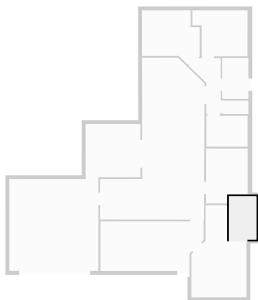

▼ **Kitchen**
Ground Floor

WIDTH: 6.75 m • LENGTH: 10.52 m
AREA: 48.09 m² • PERIMETER: 33.54 m

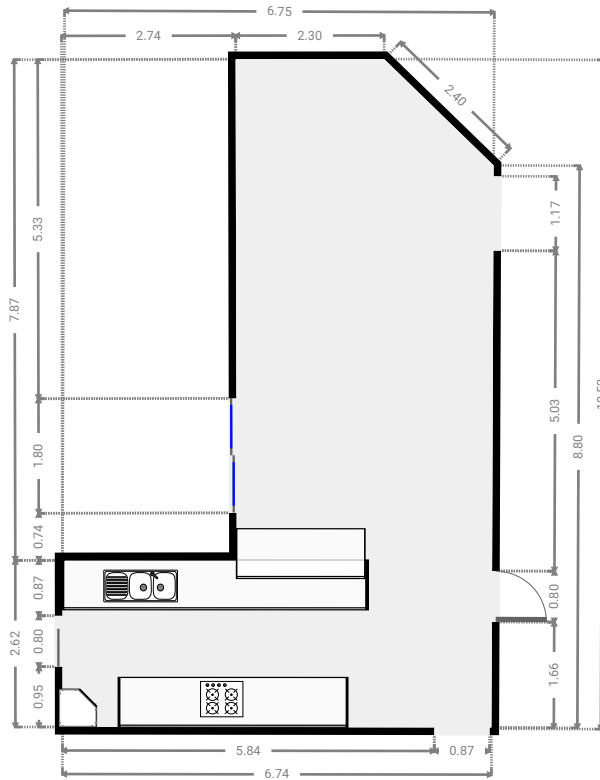
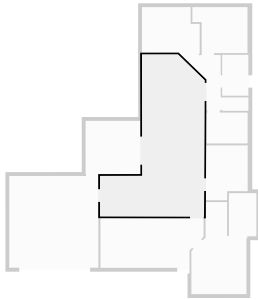

▼ **Bedroom**
Ground Floor

WIDTH: 2.70 m • LENGTH: 3.56 m
AREA: 8.82 m² • PERIMETER: 12.51 m

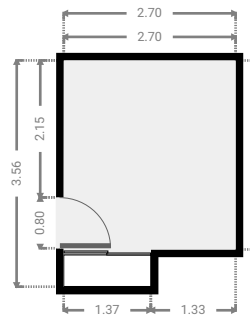
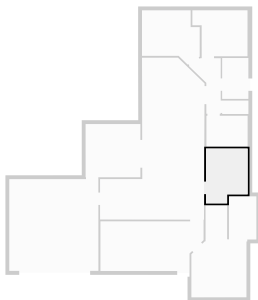

▼ **Bathroom**
Ground Floor

WIDTH: 2.67 m • LENGTH: 2.00 m
AREA: 5.34 m² • PERIMETER: 9.34 m

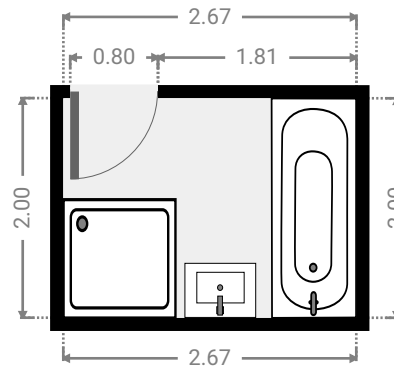
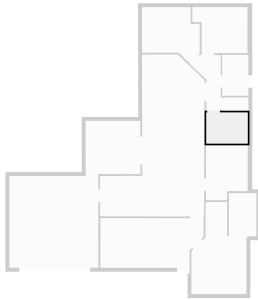

▼ **Hall**
Ground Floor

WIDTH: 2.07 m • LENGTH: 3.60 m
AREA: 4.36 m² • PERIMETER: 10.33 m

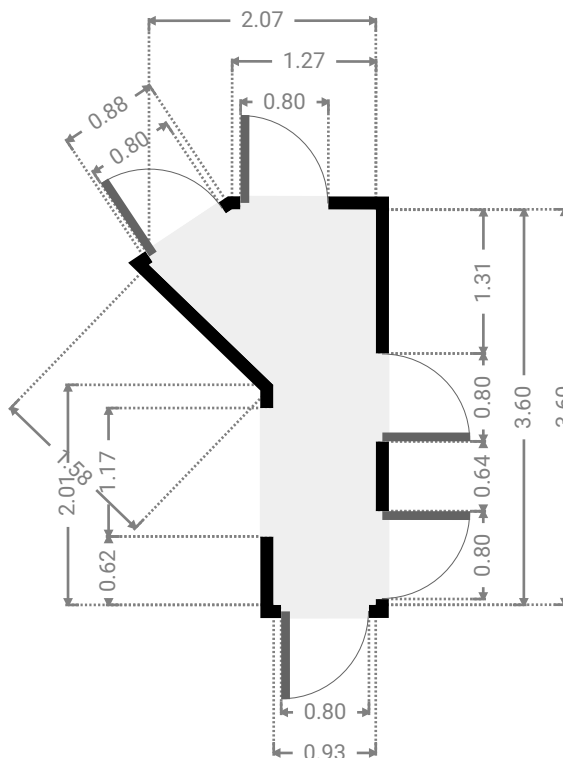
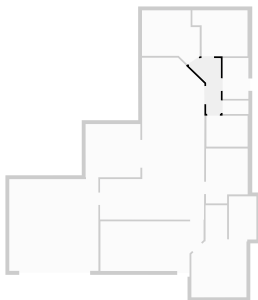

▼ **Toilet**
Ground Floor

WIDTH: 1.70 m • LENGTH: 0.87 m
AREA: 1.48 m² • PERIMETER: 5.14 m

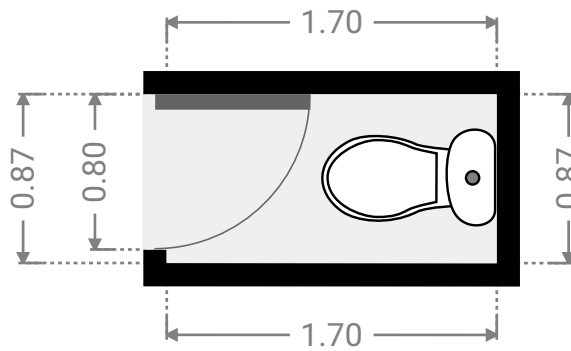
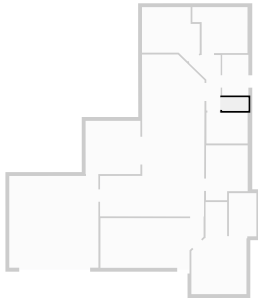

▼ **Laundry Room**
Ground Floor

WIDTH: 1.70 m • LENGTH: 2.65 m
AREA: 4.50 m² • PERIMETER: 8.70 m

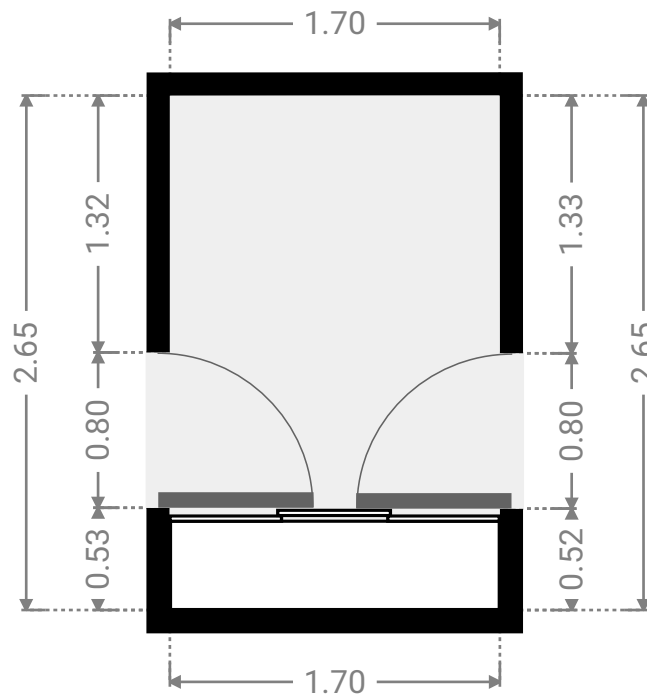
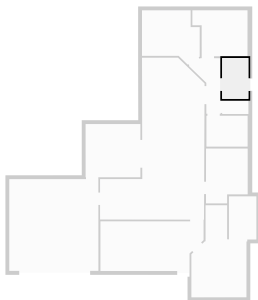

FLOORS: 1

▼ **Bedroom**
Ground Floor

WIDTH: 3.57 m • LENGTH: 2.98 m
AREA: 9.44 m² • PERIMETER: 13.10 m

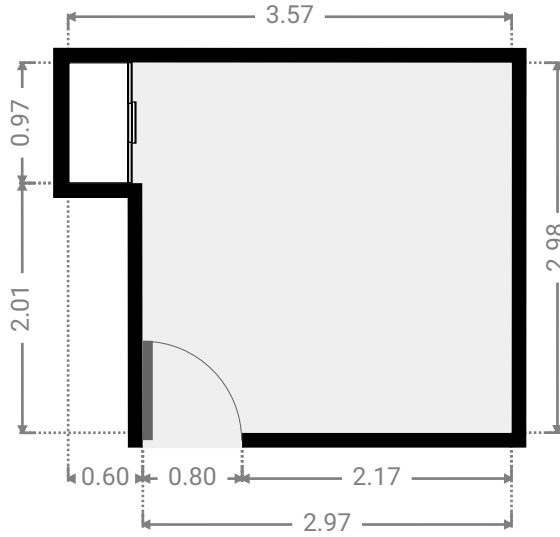
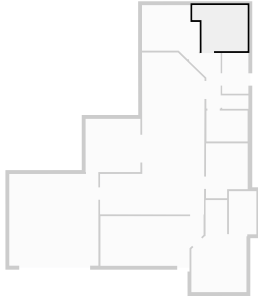

▼ **Bedroom**
Ground Floor

WIDTH: 3.75 m • LENGTH: 3.52 m
AREA: 10.82 m² • PERIMETER: 13.83 m

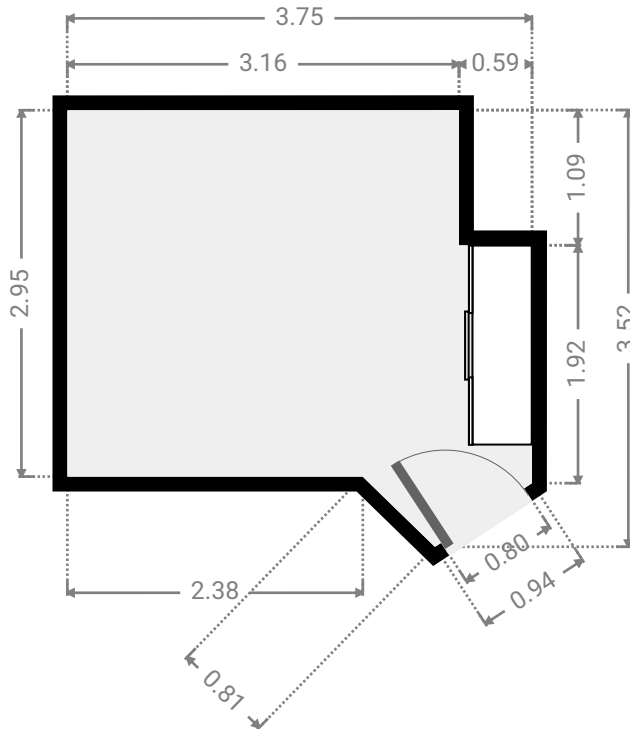
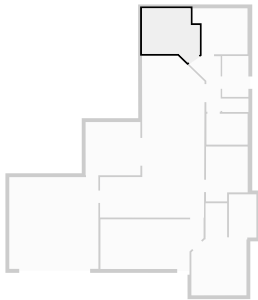

▼ **Garage**
Ground Floor

WIDTH: 5.78 m • LENGTH: 5.95 m
AREA: 34.38 m² • PERIMETER: 23.46 m

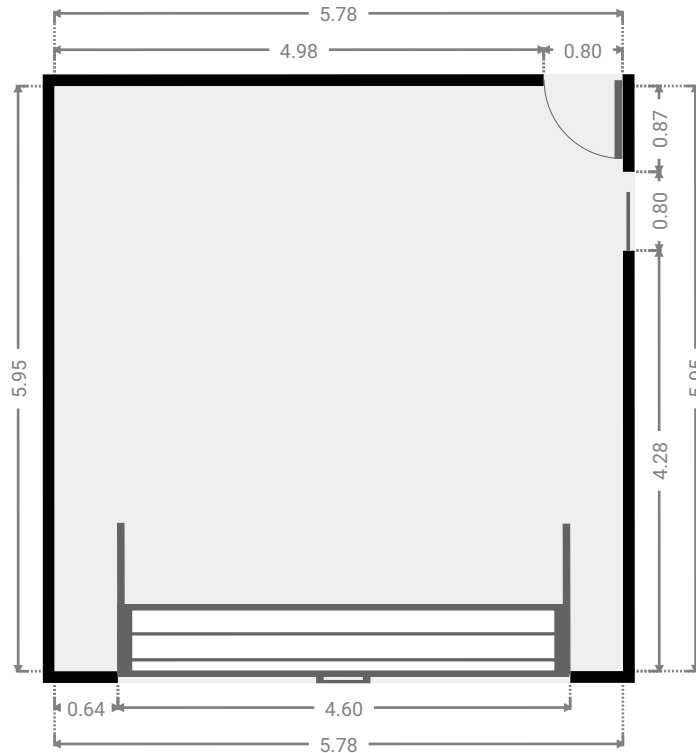
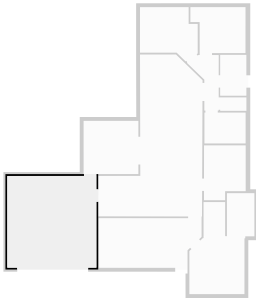

▼ **Other**
Ground Floor

WIDTH: 3.55 m • LENGTH: 3.45 m
AREA: 12.26 m² • PERIMETER: 14.00 m

