

25 Docherty Street

SUBMITTED BY

Ray White Rockhampton Casey
stockers@cqoz.com

CREATED ON

2021-12-20

Floors

2

▼ Ground Floor

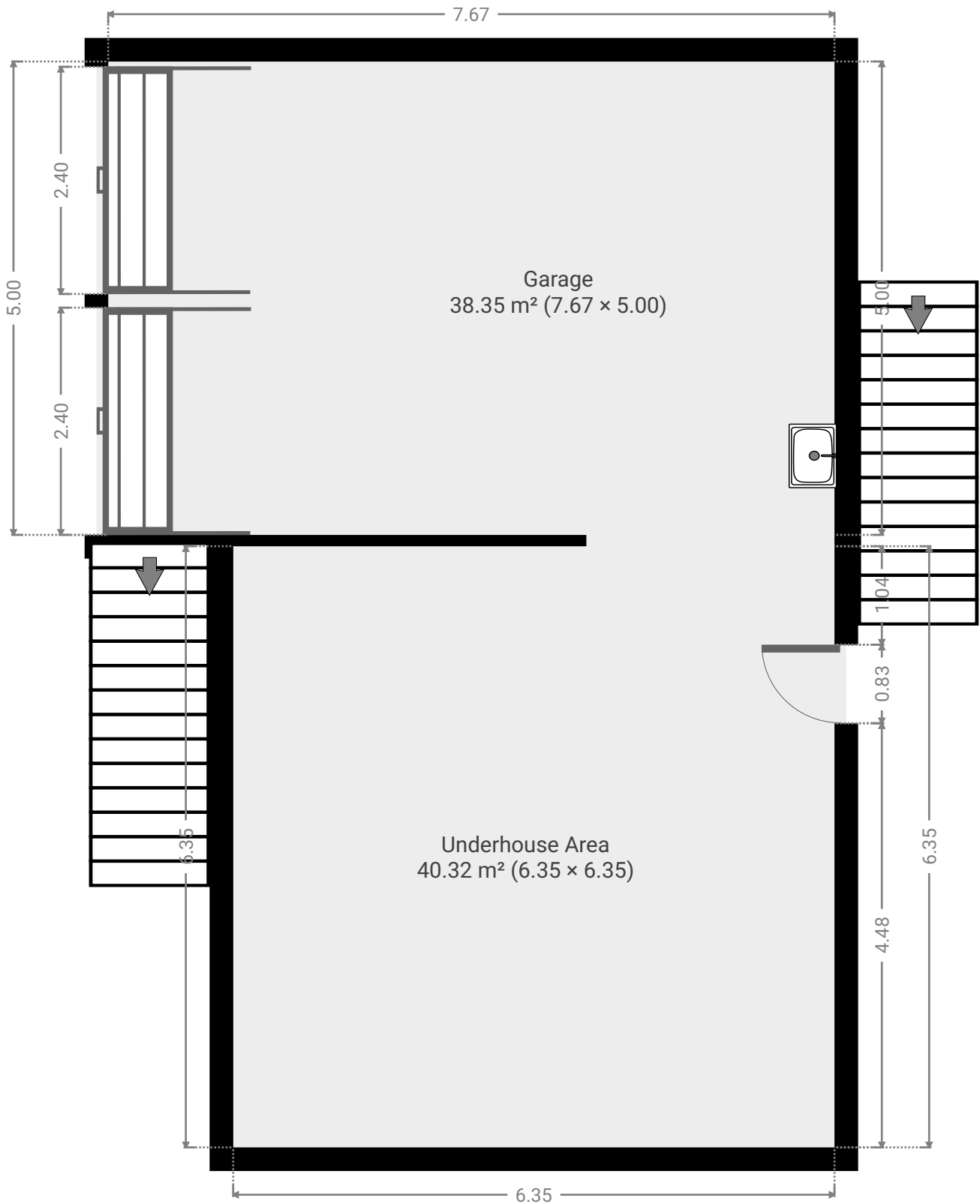

▼ **Underhouse Area**
Ground Floor

WIDTH: 6.35 m • LENGTH: 6.35 m
AREA: 40.32 m² • PERIMETER: 25.40 m

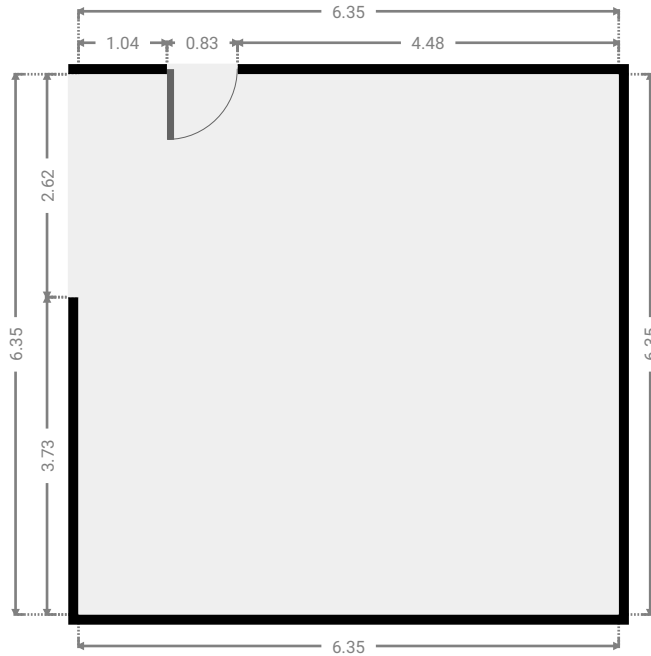
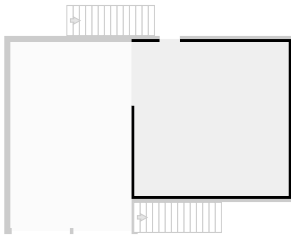

▼ **Garage**
Ground Floor

WIDTH: 5.00 m • LENGTH: 7.67 m
AREA: 38.35 m² • PERIMETER: 25.34 m

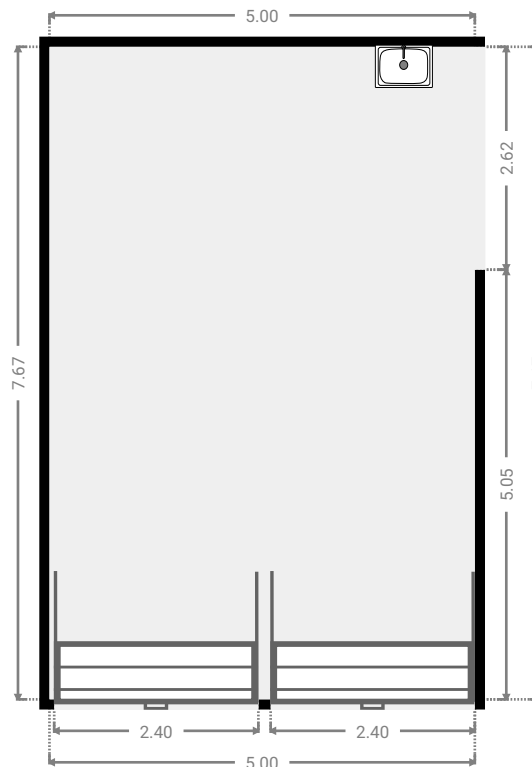
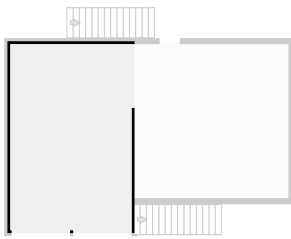

▼ 1st Floor

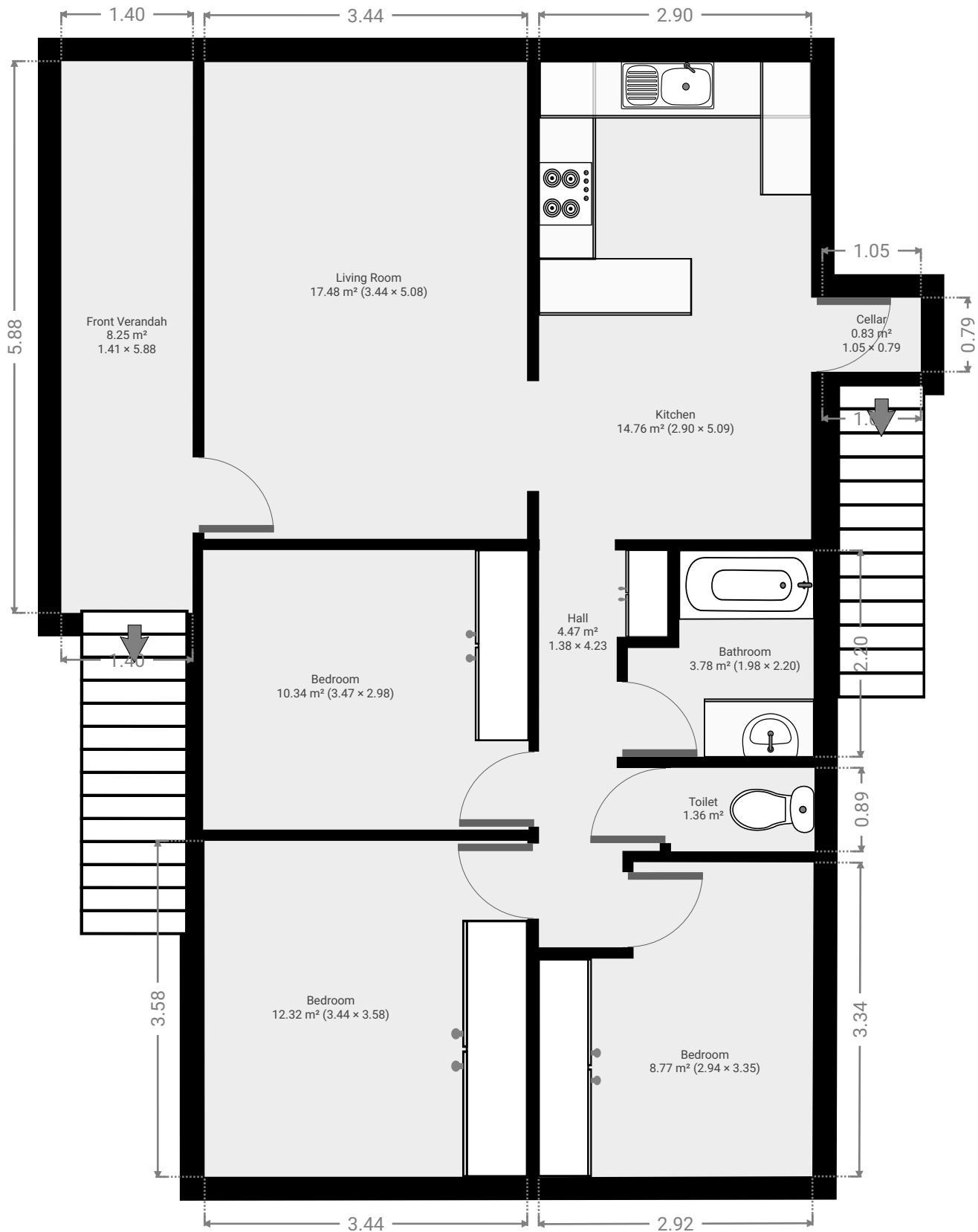

▼ **Living Room**
1st Floor

WIDTH: 5.08 m • LENGTH: 3.44 m
AREA: 17.48 m² • PERIMETER: 17.04 m

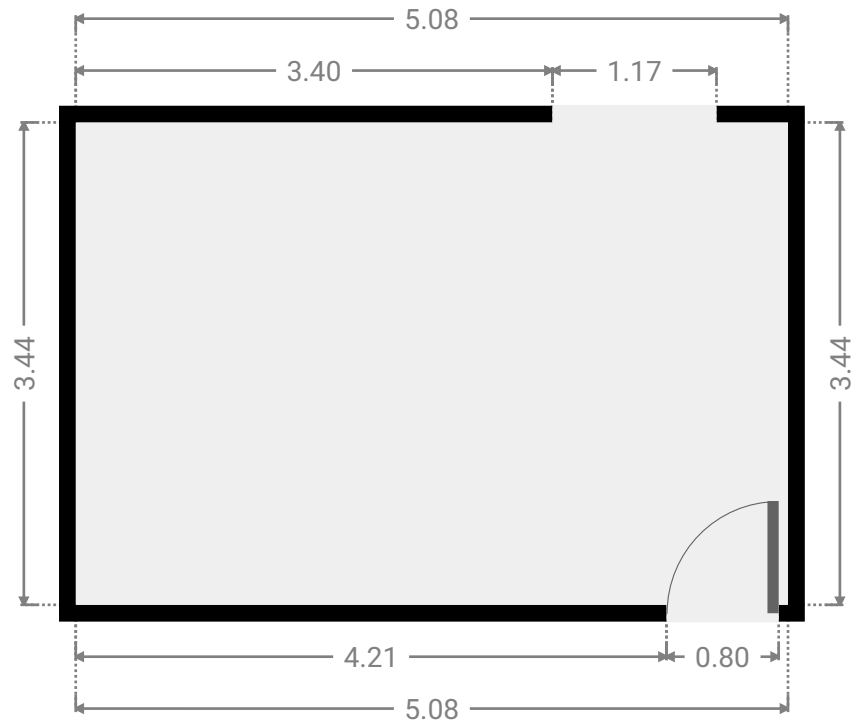
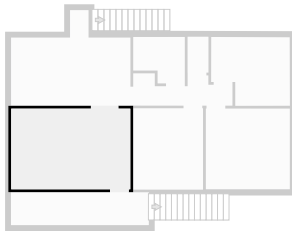

▼ **Kitchen**
1st Floor

WIDTH: 5.09 m • LENGTH: 2.90 m
AREA: 14.76 m² • PERIMETER: 15.98 m

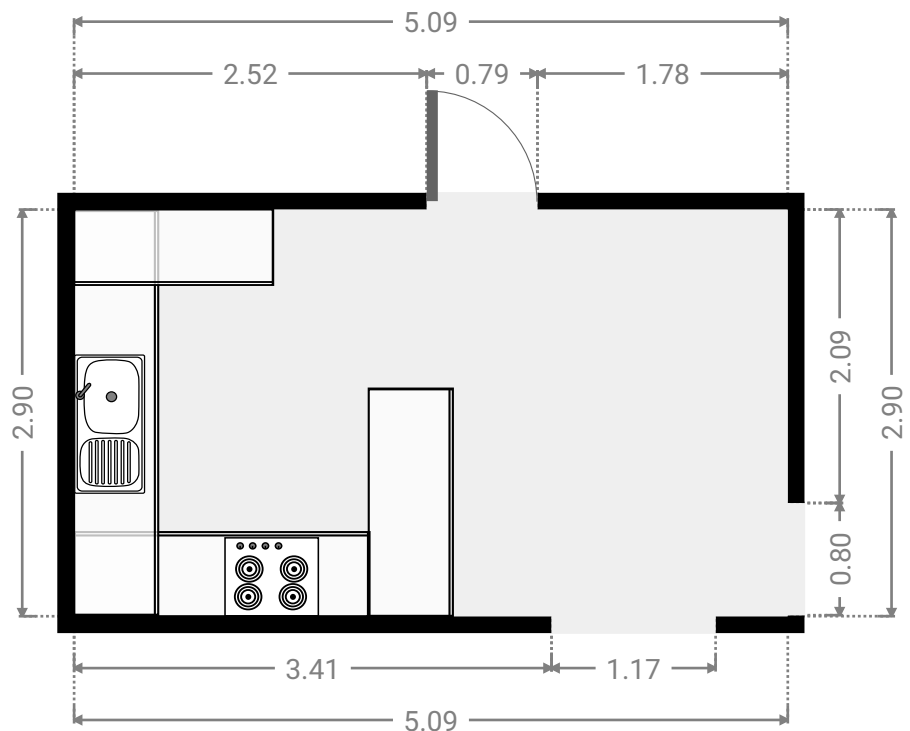
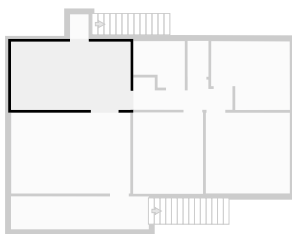

▼ **Hall**
1st Floor

WIDTH: 4.23 m • LENGTH: 1.38 m
AREA: 4.47 m² • PERIMETER: 12.13 m

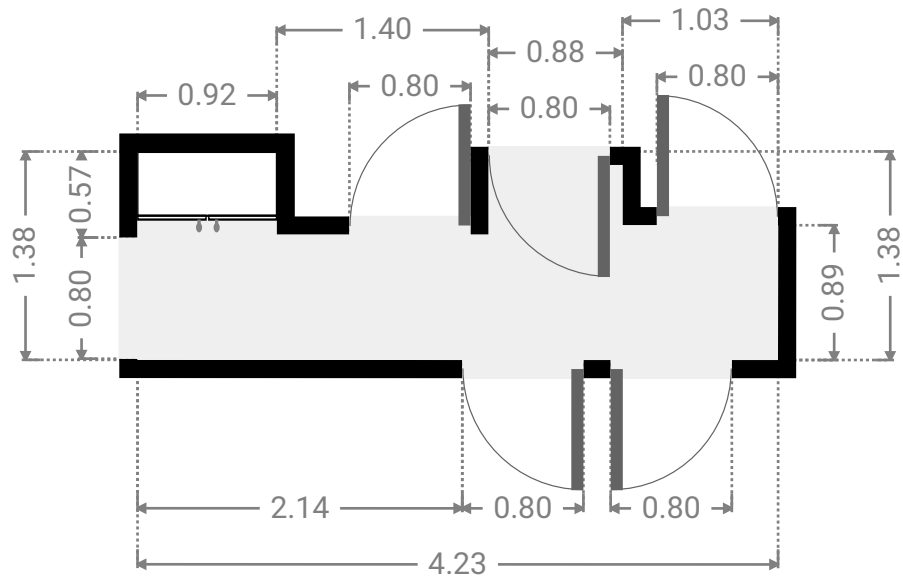
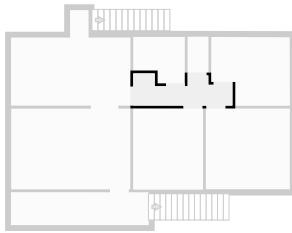

▼ **Bathroom**
1st Floor

WIDTH: 2.20 m • LENGTH: 1.98 m
AREA: 3.78 m² • PERIMETER: 8.36 m

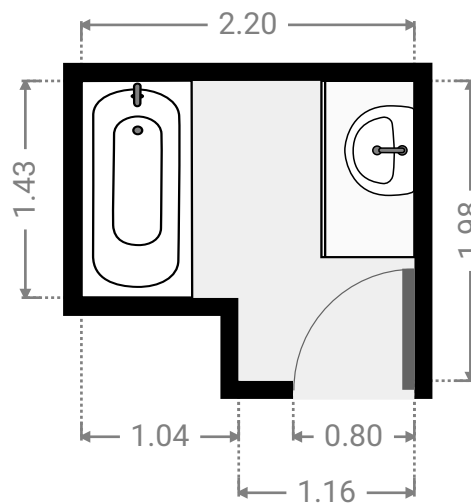
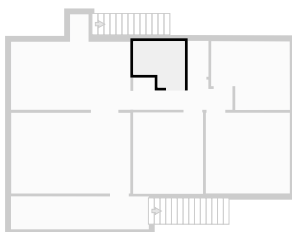

▼ **Toilet**
1st Floor

WIDTH: 0.89 m • LENGTH: 1.53 m
AREA: 1.36 m² • PERIMETER: 4.84 m

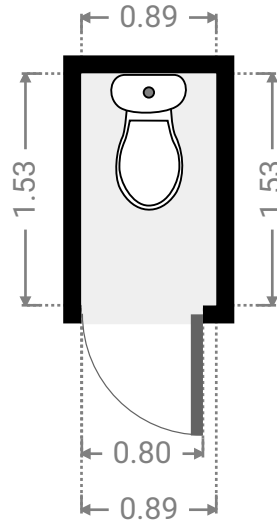
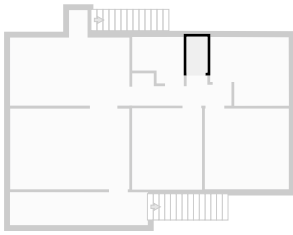

▼ **Bedroom**
1st Floor

WIDTH: 2.98 m • LENGTH: 3.47 m
AREA: 10.34 m² • PERIMETER: 12.90 m

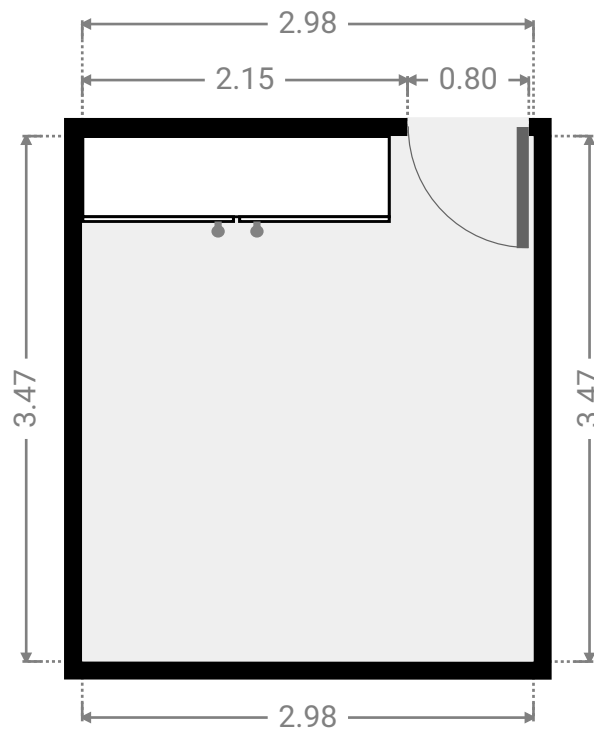
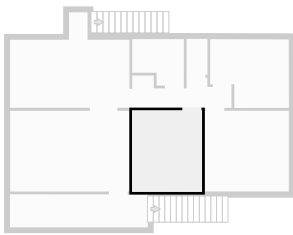

▼ **Bedroom**
1st Floor

WIDTH: 3.58 m • LENGTH: 3.44 m
AREA: 12.32 m² • PERIMETER: 14.04 m

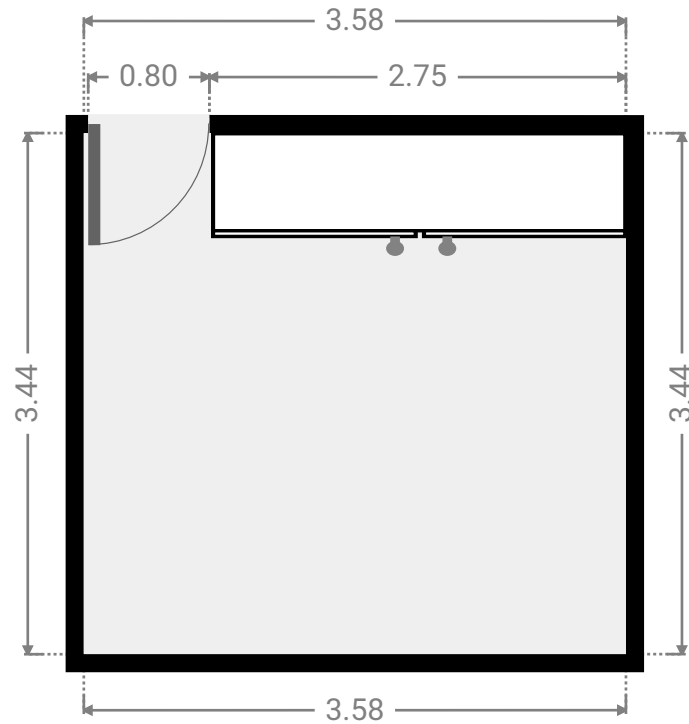
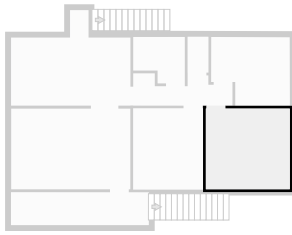

▼ **Bedroom**
1st Floor

WIDTH: 3.35 m • LENGTH: 2.94 m
AREA: 8.77 m² • PERIMETER: 12.56 m

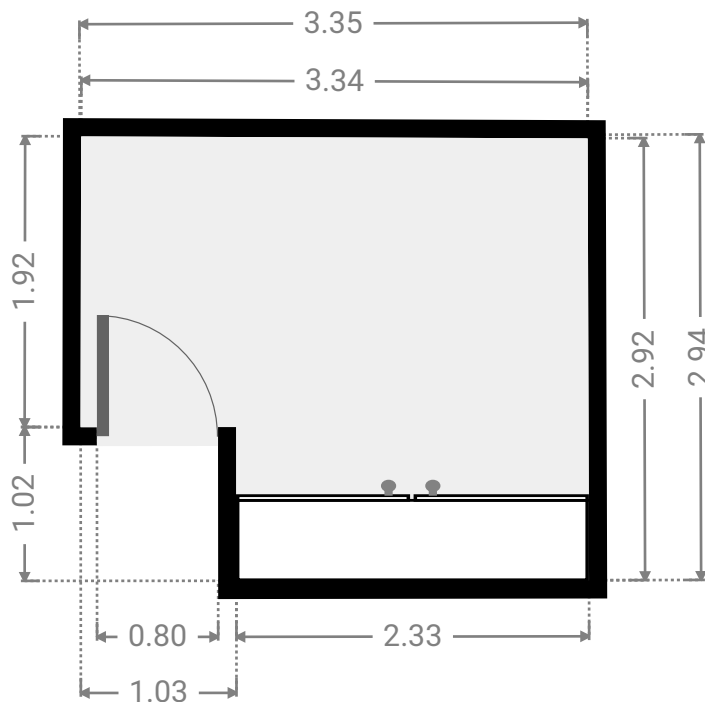
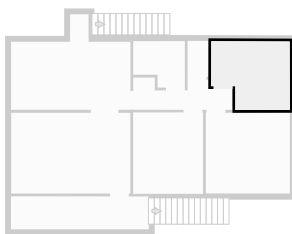

▼ **Cellar**
1st Floor

WIDTH: 0.79 m • LENGTH: 1.05 m
AREA: 0.83 m² • PERIMETER: 3.68 m

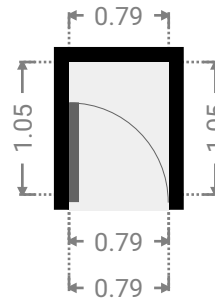
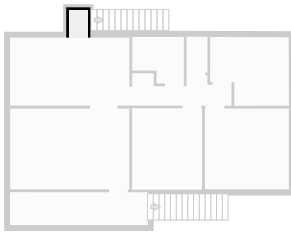

▼ **Front Verandah**
1st Floor

WIDTH: 5.88 m • LENGTH: 1.41 m
AREA: 8.25 m² • PERIMETER: 14.56 m

