

# 25 Bean Avenue

## Ground Floor

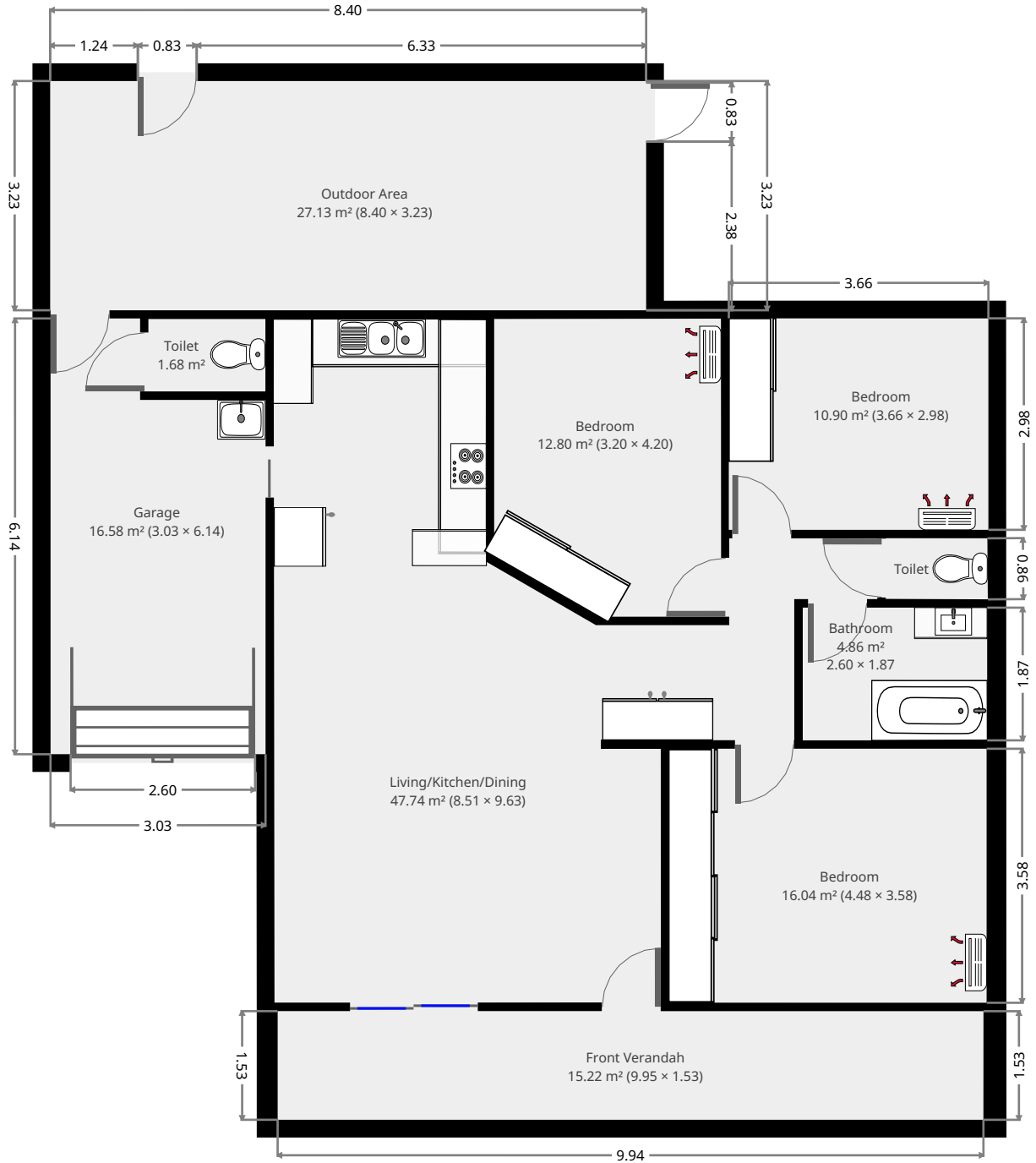

THIS FLOORPLAN IS PROVIDED WITHOUT WARRANTY OF ANY KIND. SENSOPIA DISCLAIMS ANY WARRANTY INCLUDING, WITHOUT LIMITATION, SATISFACTORY QUALITY OR ACCURACY OF DIMENSIONS.



# 25 Bean Avenue

## Living/Kitchen/Dining

Width: 8.51 m  
 Length: 9.63 m  
 Area: 47.74 m<sup>2</sup>  
 Perimeter: 38.06 m

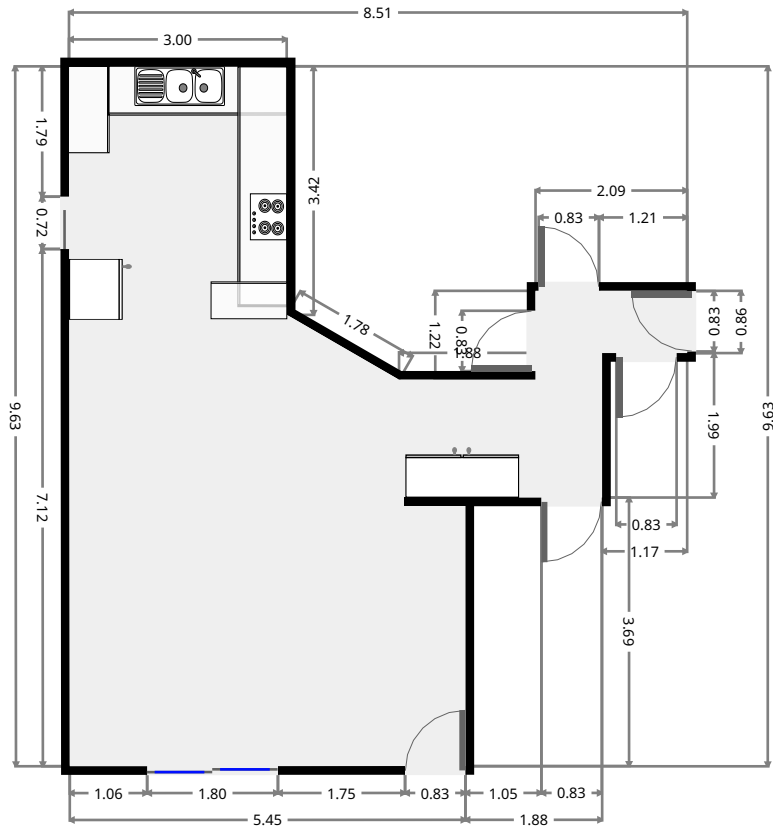
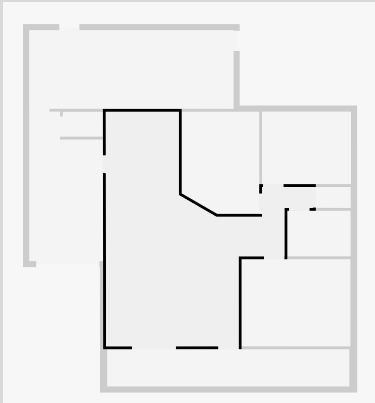

## Bedroom

Width: 3.58 m  
 Length: 4.48 m  
 Area: 16.04 m<sup>2</sup>  
 Perimeter: 16.12 m

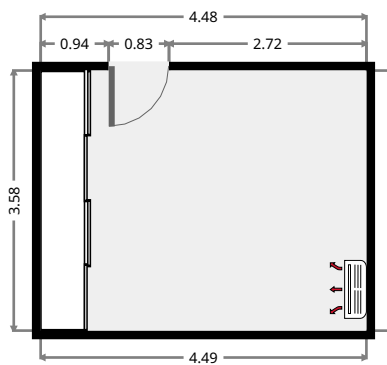
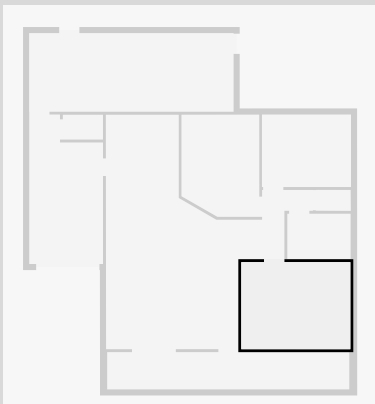

# 25 Bean Avenue

## Bedroom

Width: 3.20 m  
 Length: 4.20 m  
 Area: 12.80 m<sup>2</sup>  
 Perimeter: 14.17 m

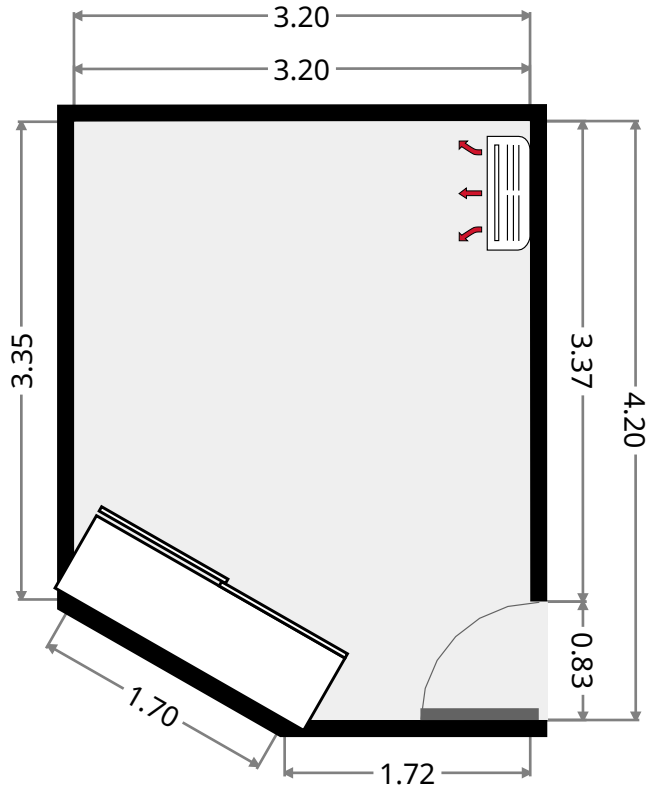
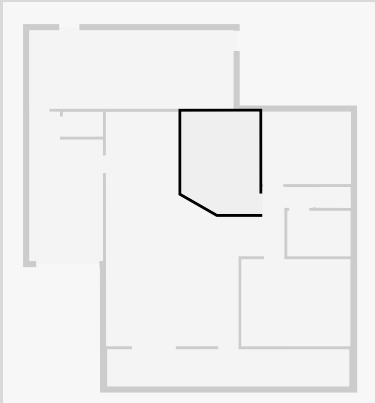

## Bedroom

Width: 2.98 m  
 Length: 3.66 m  
 Area: 10.90 m<sup>2</sup>  
 Perimeter: 13.28 m

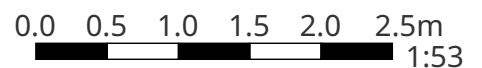
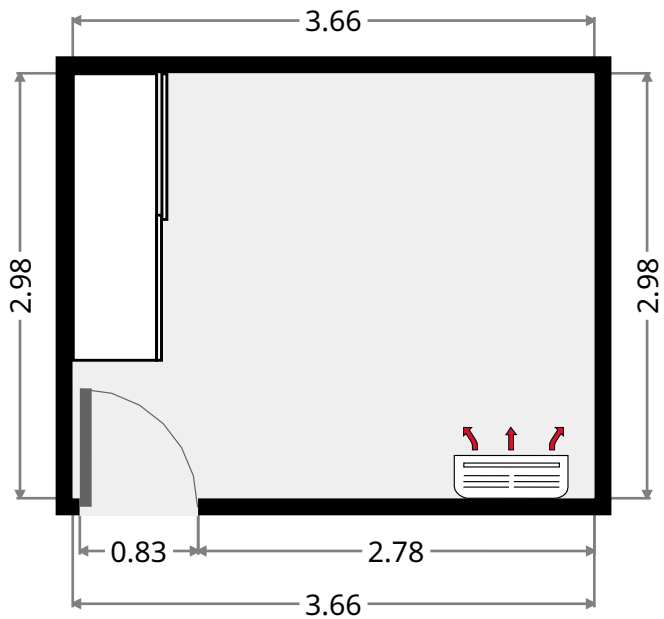
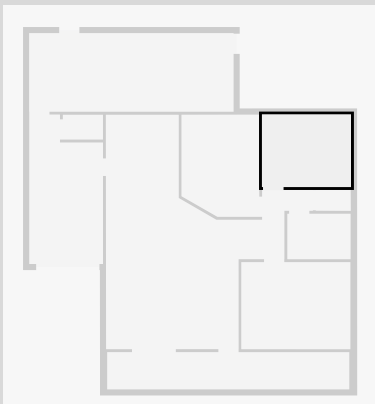

THIS FLOORPLAN IS PROVIDED WITHOUT WARRANTY OF ANY KIND. SENSOPIA DISCLAIMS ANY WARRANTY INCLUDING, WITHOUT LIMITATION, SATISFACTORY QUALITY OR ACCURACY OF DIMENSIONS.

# 25 Bean Avenue

## Bathroom

Width: 1.87 m  
 Length: 2.60 m  
 Area: 4.86 m<sup>2</sup>  
 Perimeter: 8.94 m

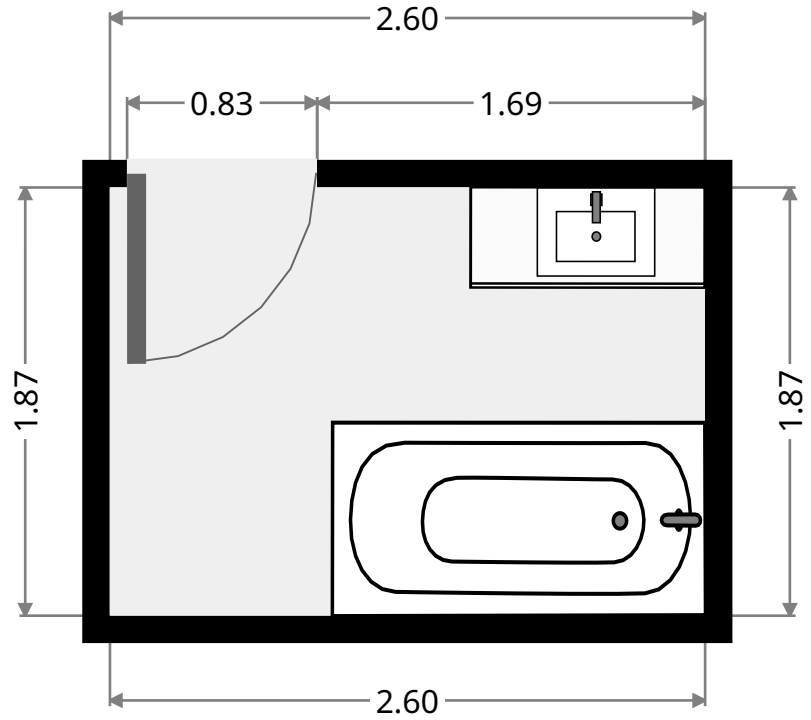
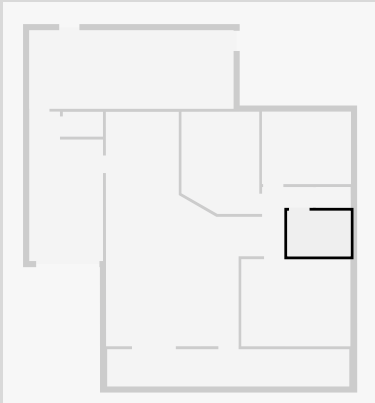

## Toilet / Half Bath

Width: 0.86 m  
 Length: 1.44 m  
 Area: 1.23 m<sup>2</sup>  
 Perimeter: 4.58 m

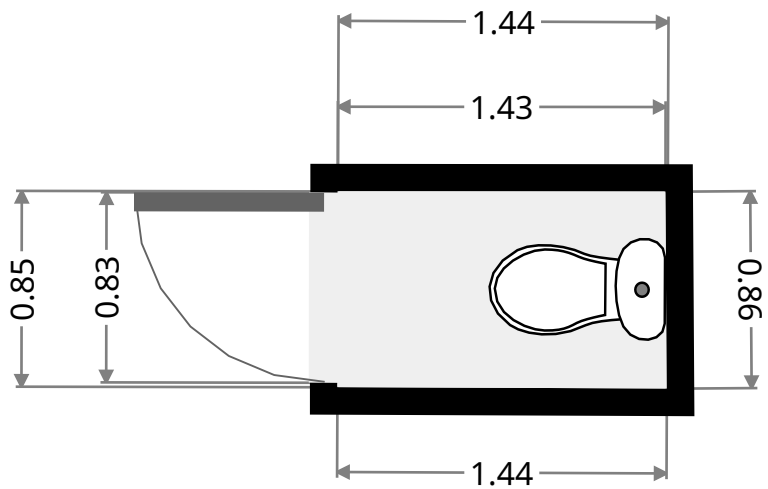
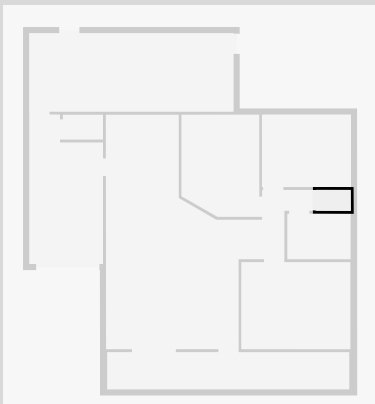

THIS FLOORPLAN IS PROVIDED WITHOUT WARRANTY OF ANY KIND. SENSOPIA DISCLAIMS ANY WARRANTY INCLUDING, WITHOUT LIMITATION, SATISFACTORY QUALITY OR ACCURACY OF DIMENSIONS.

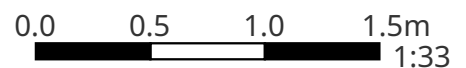

# 25 Bean Avenue

## Toilet / Half Bath

Width: 1.02 m  
Length: 1.65 m  
Area: 1.68 m<sup>2</sup>  
Perimeter: 5.34 m

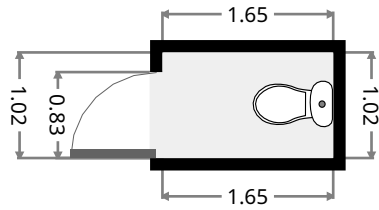
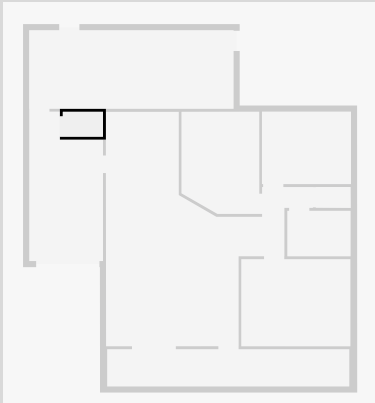

## Garage

Width: 3.03 m  
Length: 6.14 m  
Area: 16.58 m<sup>2</sup>  
Perimeter: 18.34 m

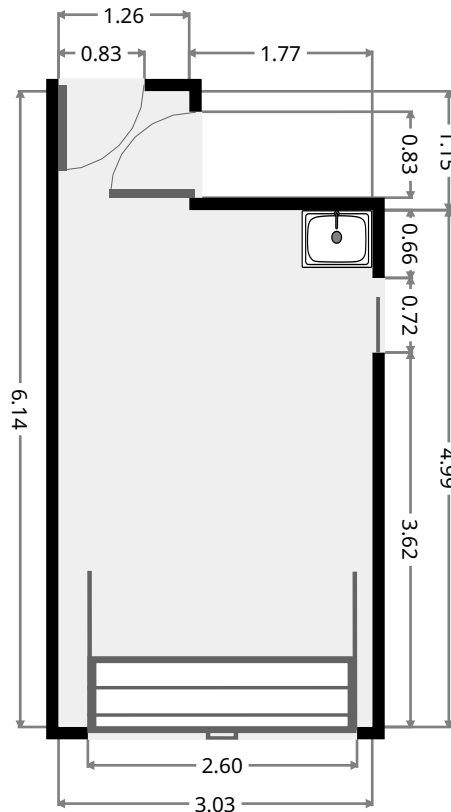
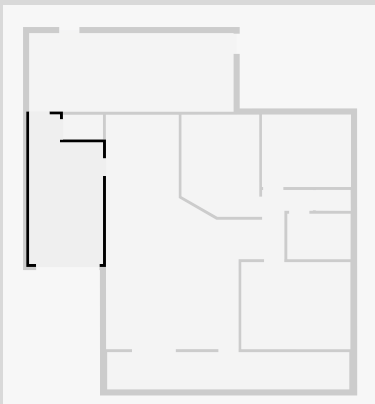

THIS FLOORPLAN IS PROVIDED WITHOUT WARRANTY OF ANY KIND. SENSOPIA DISCLAIMS ANY WARRANTY INCLUDING, WITHOUT LIMITATION, SATISFACTORY QUALITY OR ACCURACY OF DIMENSIONS.

# 25 Bean Avenue

## Front Verandah

Width: 1.53 m  
Length: 9.95 m  
Area: 15.22 m<sup>2</sup>  
Perimeter: 22.96 m

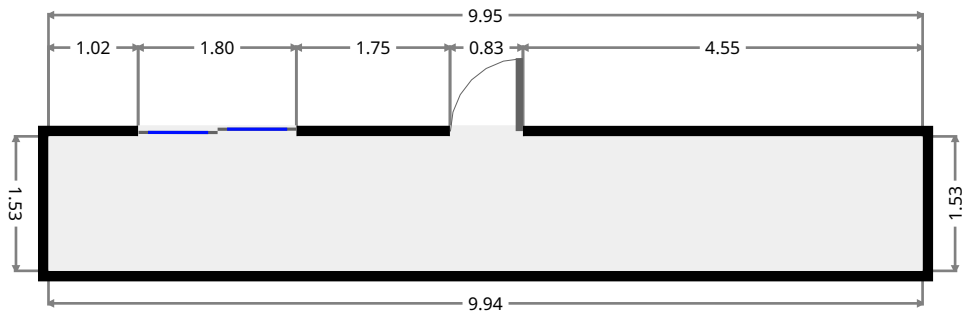
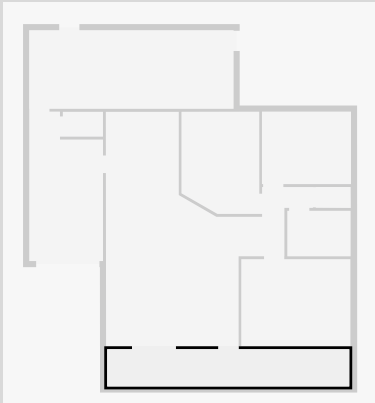

## Outdoor Area

Width: 3.23 m  
Length: 8.40 m  
Area: 27.13 m<sup>2</sup>  
Perimeter: 23.26 m

