

24 Plumb Drive

Ground Floor



THIS FLOORPLAN IS PROVIDED WITHOUT WARRANTY OF ANY KIND. SENSOPIA DISCLAIMS ANY WARRANTY INCLUDING, WITHOUT LIMITATION, SATISFACTORY QUALITY OR ACCURACY OF DIMENSIONS.



24 Plumb Drive

Living/Kitchen/Dining

Width: 8.34 m
 Length: 9.97 m
 Area: 43.16 m²
 Perimeter: 36.61 m

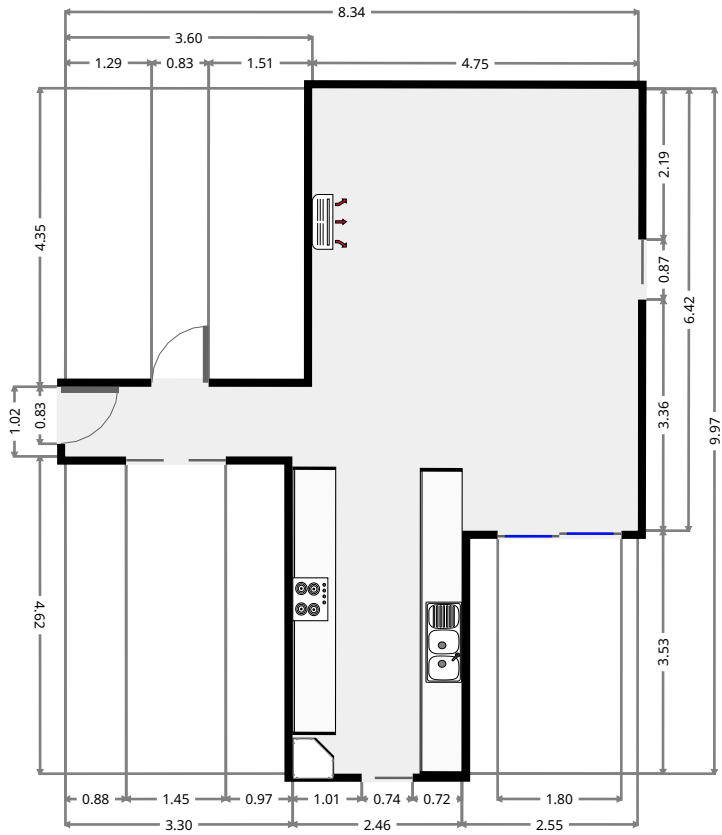
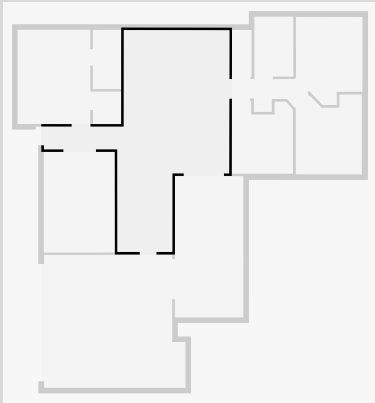

Living Room

Width: 3.20 m
 Length: 4.55 m
 Area: 14.55 m²
 Perimeter: 15.49 m

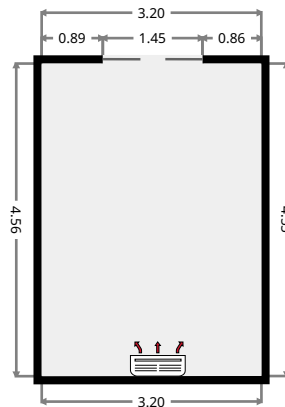
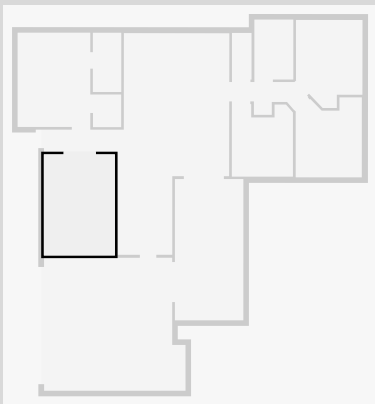

24 Plumb Drive

Master Bedroom

Width: 3.27 m
Length: 4.24 m
Area: 13.86 m²
Perimeter: 15.02 m

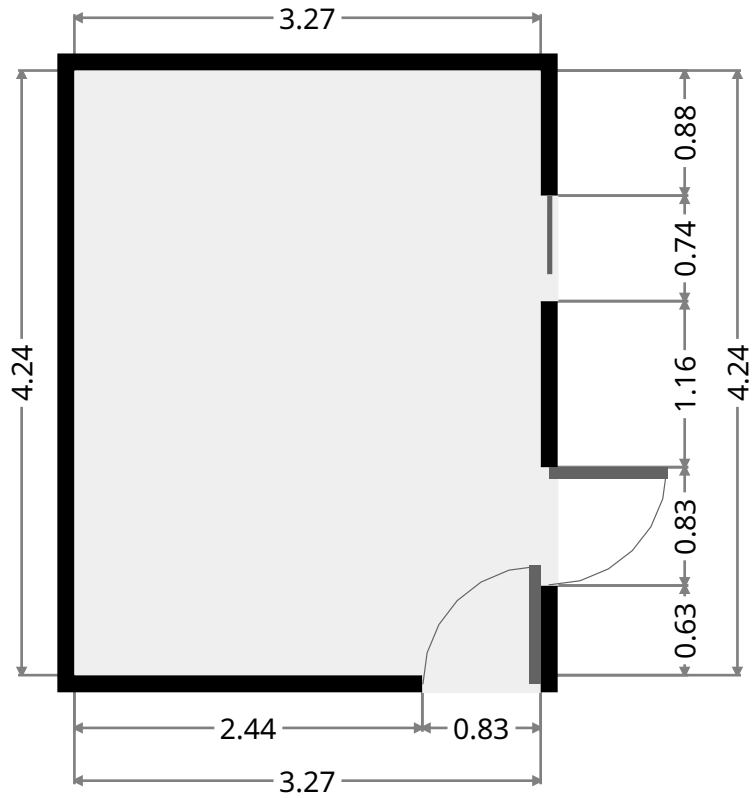
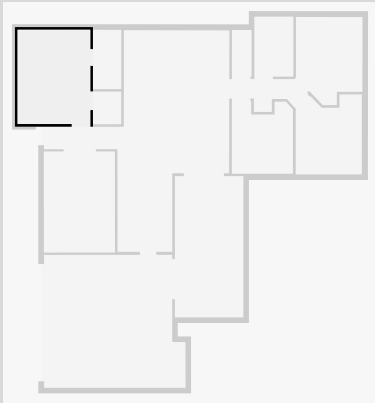

Closet

Width: 1.27 m
Length: 1.47 m
Area: 1.87 m²
Perimeter: 5.48 m

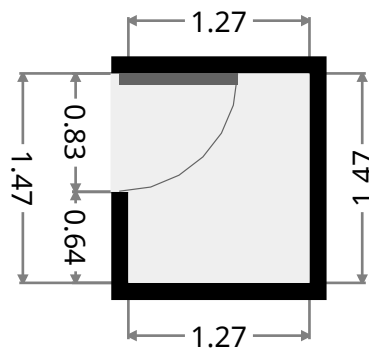
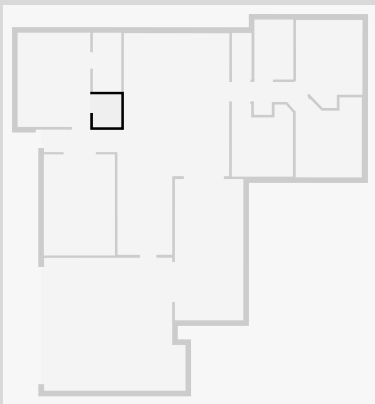

24 Plumb Drive

Bathroom

Width: 1.28 m
 Length: 2.67 m
 Area: 3.41 m²
 Perimeter: 7.89 m

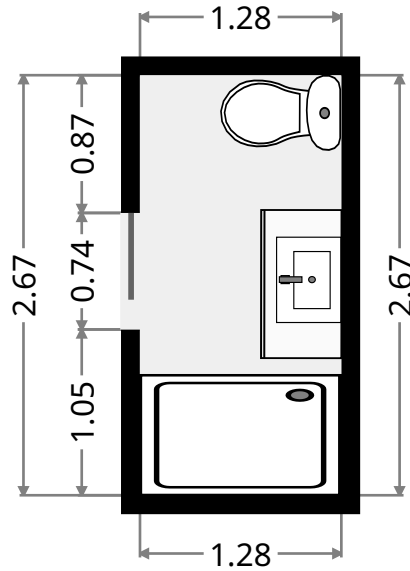
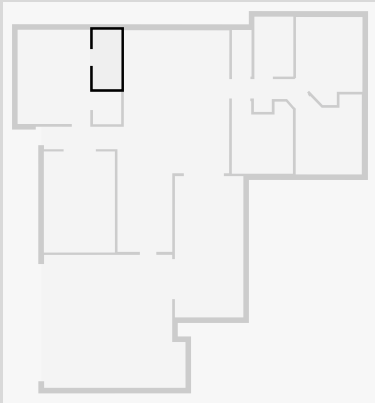

Hall

Width: 1.48 m
 Length: 3.45 m
 Area: 3.43 m²
 Perimeter: 9.66 m

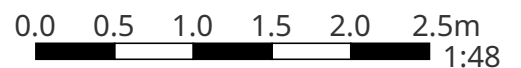
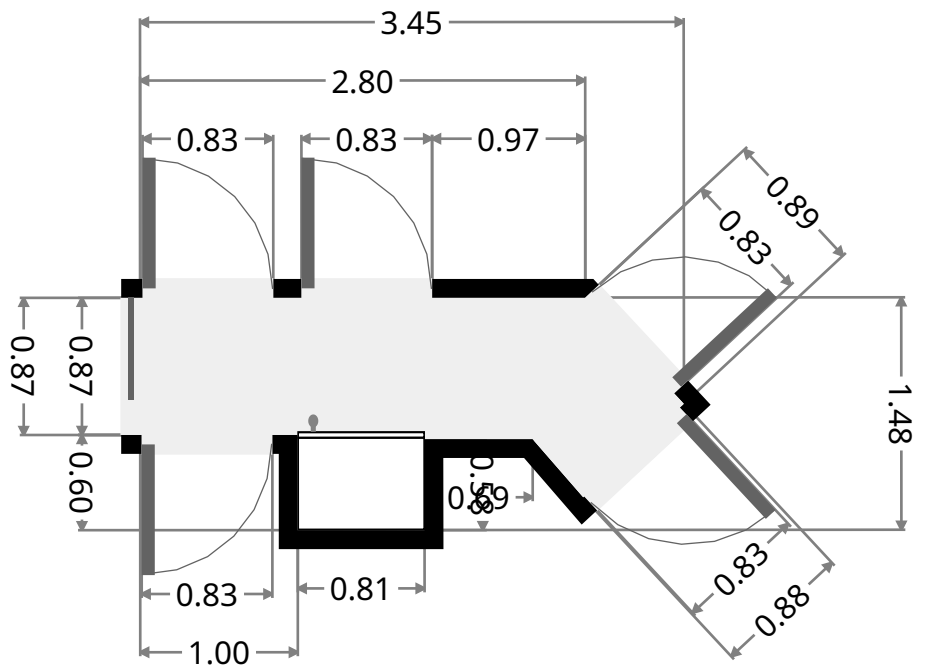
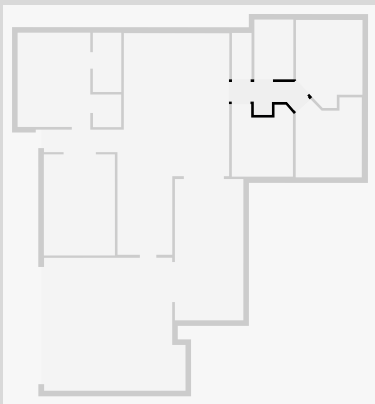

THIS FLOORPLAN IS PROVIDED WITHOUT WARRANTY OF ANY KIND. SENSOPIA DISCLAIMS ANY WARRANTY INCLUDING, WITHOUT LIMITATION, SATISFACTORY QUALITY OR ACCURACY OF DIMENSIONS.

24 Plumb Drive

Toilet / Half Bath

Width: 0.88 m
Length: 2.10 m
Area: 1.85 m²
Perimeter: 5.96 m

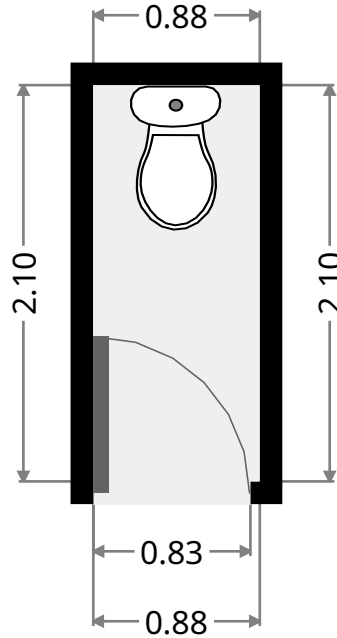
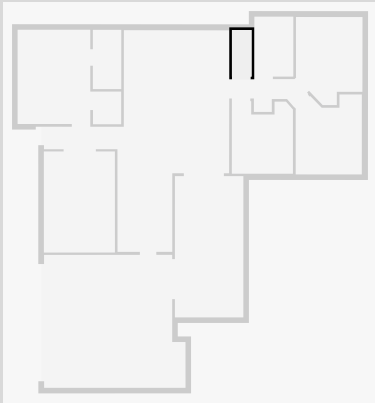

Bathroom

Width: 1.75 m
Length: 2.70 m
Area: 4.72 m²
Perimeter: 8.90 m

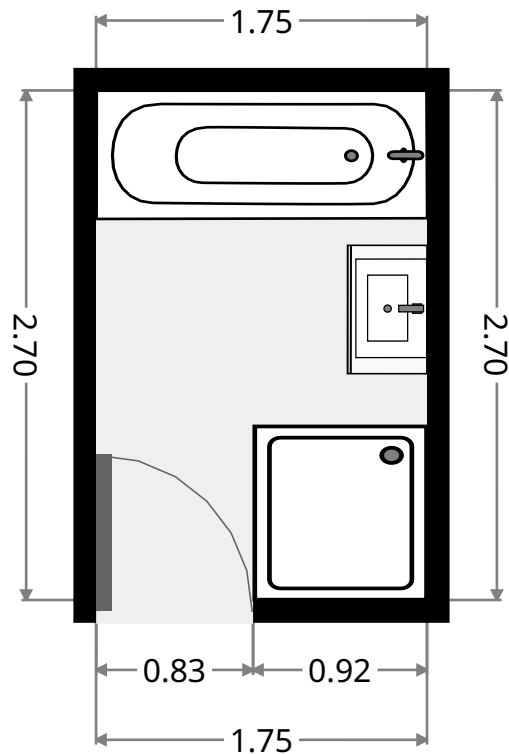
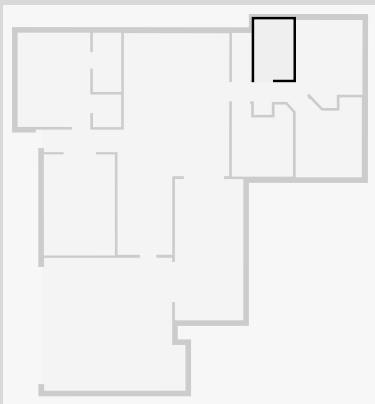

24 Plumb Drive

Bedroom

Width: 2.99 m
 Length: 3.96 m
 Area: 10.40 m²
 Perimeter: 13.19 m

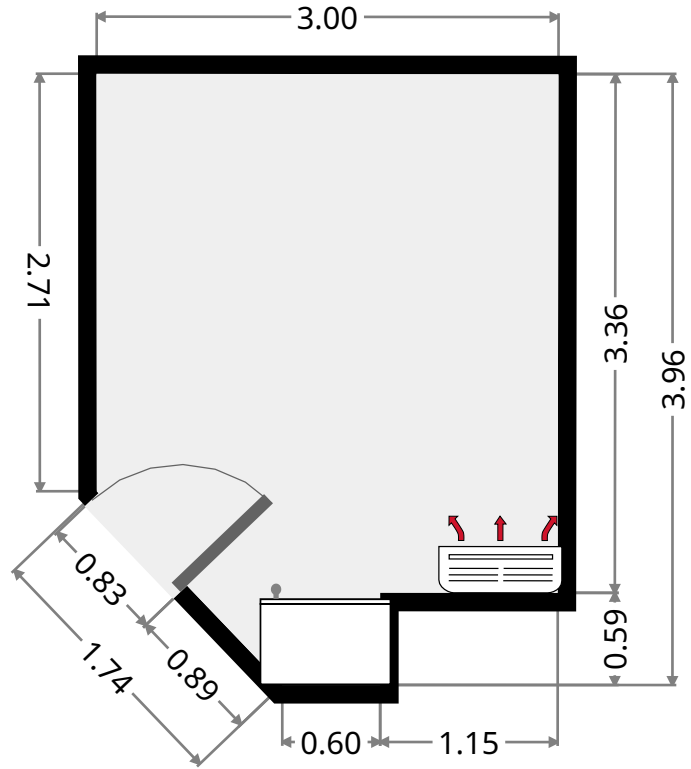
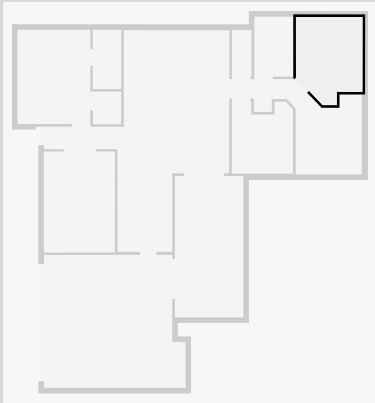

Bedroom

Width: 2.98 m
 Length: 3.60 m
 Area: 9.80 m²
 Perimeter: 13.52 m

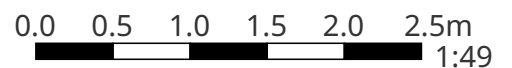
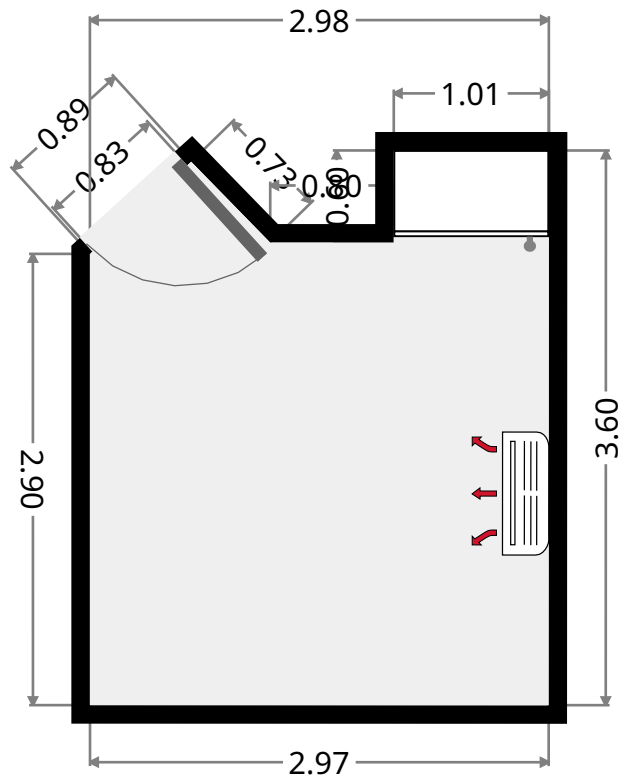
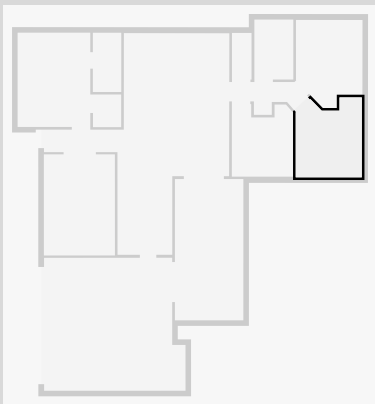

24 Plumb Drive

Bedroom

Width: 2.75 m
Length: 3.26 m
Area: 8.26 m²
Perimeter: 12.99 m

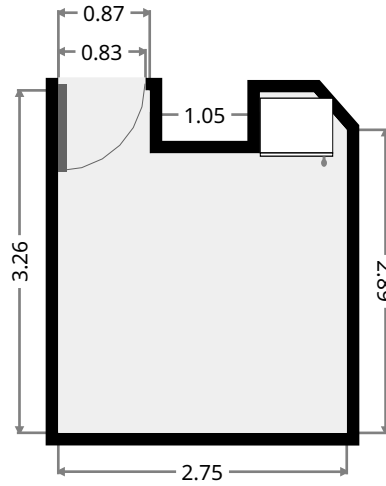
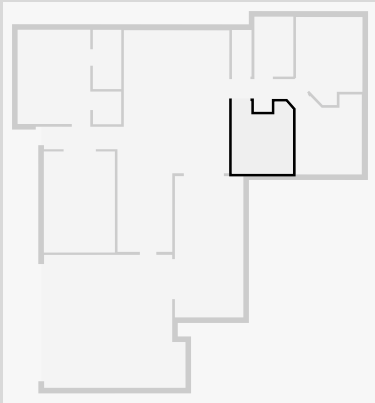

Outdoor Area

Width: 3.08 m
Length: 6.36 m
Area: 19.57 m²
Perimeter: 18.87 m

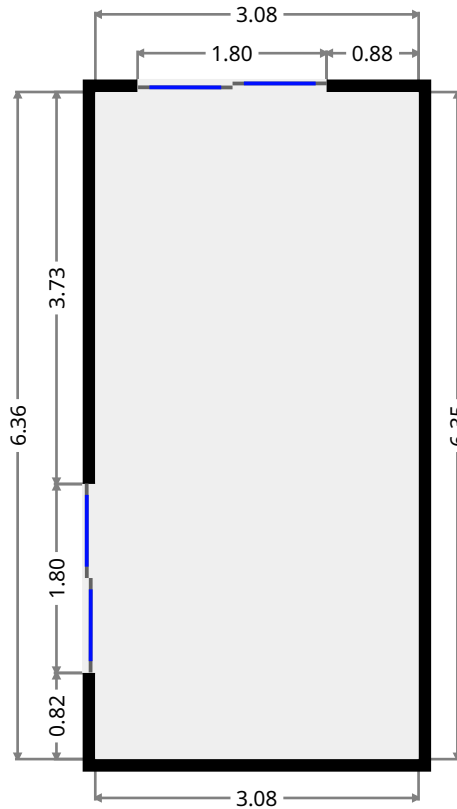
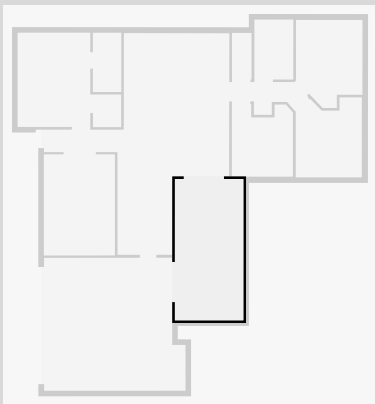

24 Plumb Drive

Garage

Width: 5.98 m
Length: 6.36 m
Area: 35.71 m²
Perimeter: 24.69 m

