

232 German Street

Hall

Width: 1.62 m
Length: 1.66 m
Area: 1.84 m²
Perimeter: 6.16 m

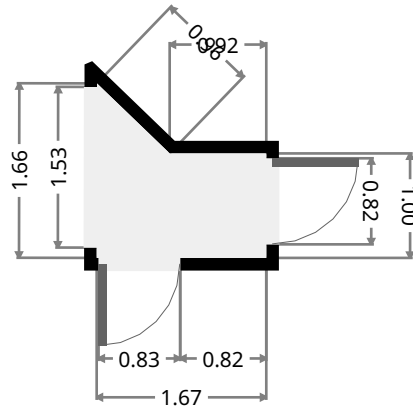
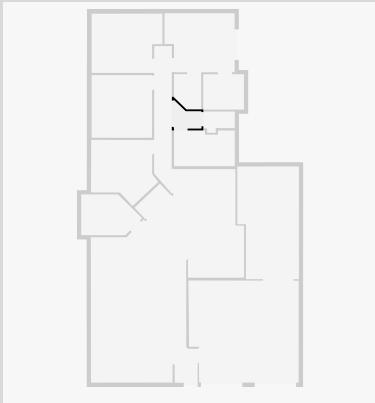

Kitchen/Dining

Width: 4.17 m
Length: 6.39 m
Area: 25.81 m²
Perimeter: 21.91 m

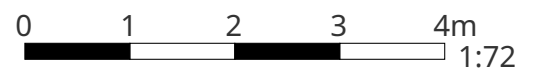
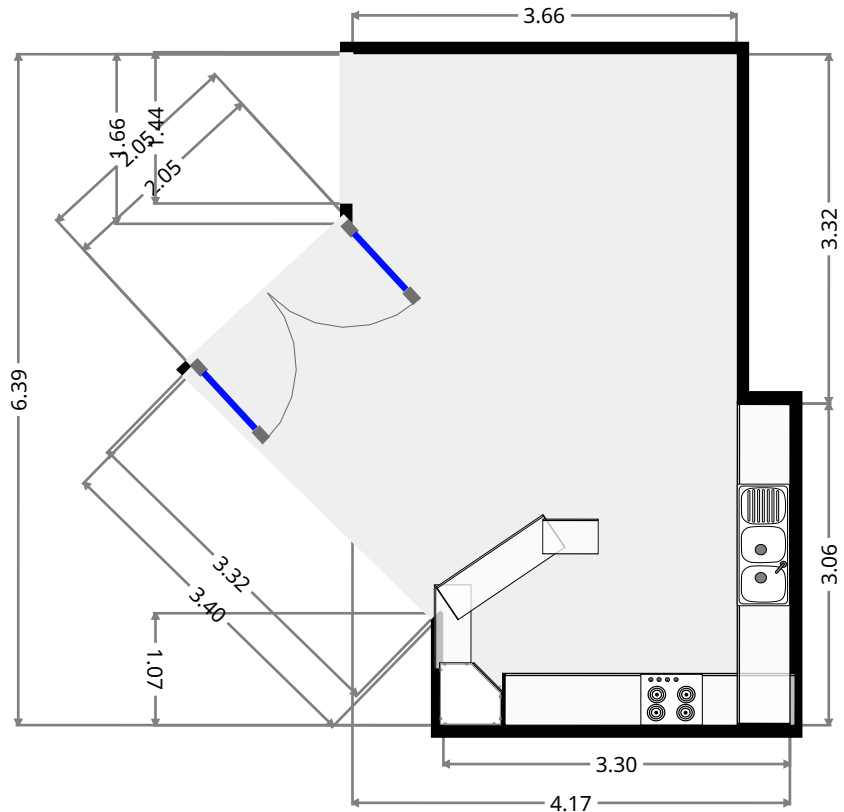
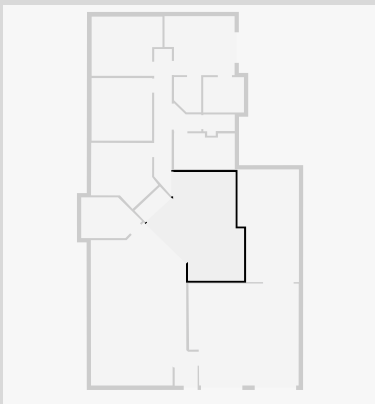

THIS FLOORPLAN IS PROVIDED WITHOUT WARRANTY OF ANY KIND. SENSOPIA DISCLAIMS ANY WARRANTY INCLUDING, WITHOUT LIMITATION, SATISFACTORY QUALITY OR ACCURACY OF DIMENSIONS.

232 German Street

Outdoor Area

Width: 3.63 m
 Length: 6.65 m
 Area: 22.46 m²
 Perimeter: 20.54 m

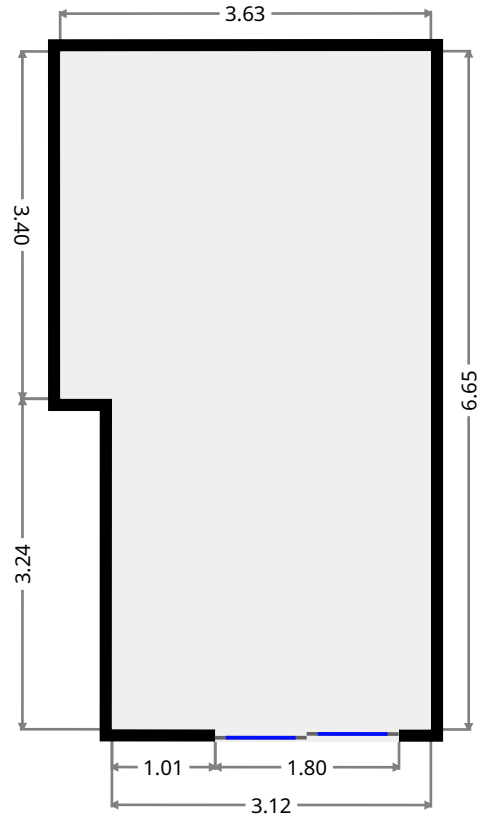
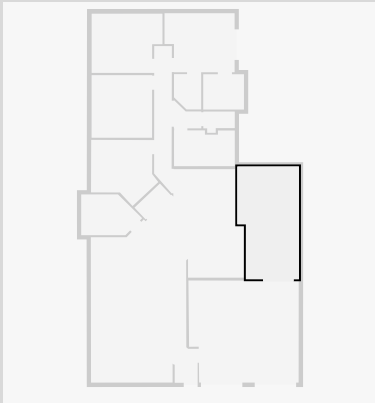

Garage

Width: 6.00 m
 Length: 6.50 m
 Area: 37.63 m²
 Perimeter: 24.95 m

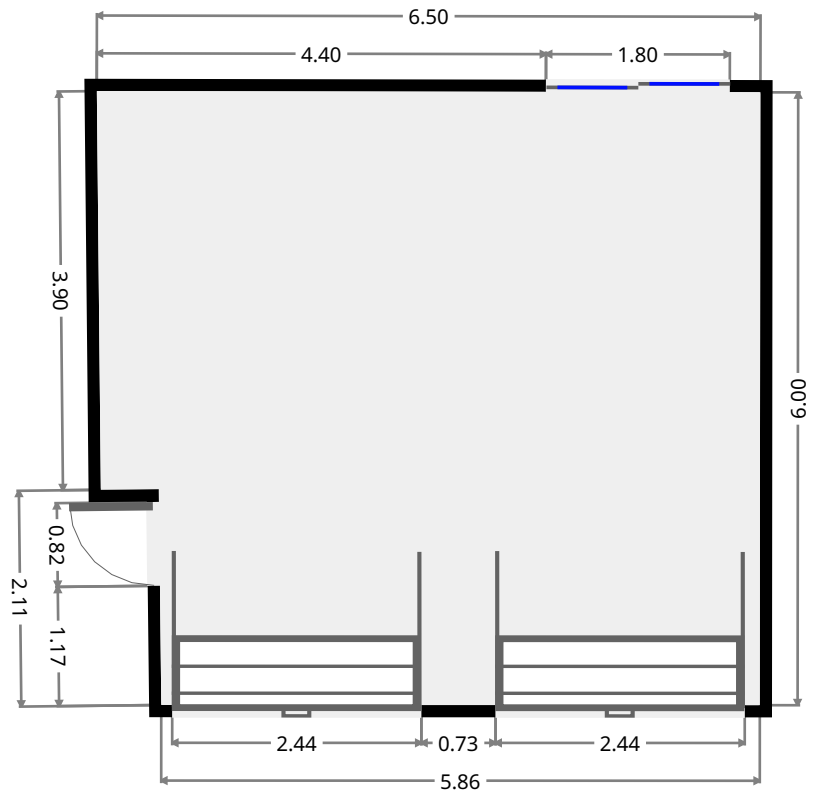
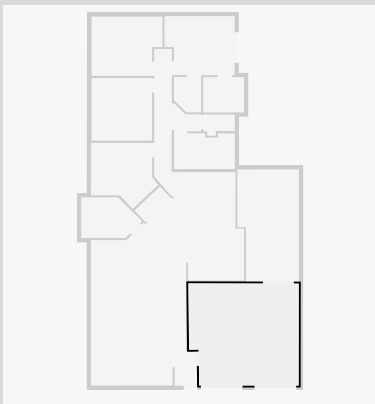

THIS FLOORPLAN IS PROVIDED WITHOUT WARRANTY OF ANY KIND. SENSOPIA DISCLAIMS ANY WARRANTY INCLUDING, WITHOUT LIMITATION, SATISFACTORY QUALITY OR ACCURACY OF DIMENSIONS.

232 German Street

Bathroom

Width: 2.08 m
Length: 2.40 m
Area: 4.99 m²
Perimeter: 8.96 m

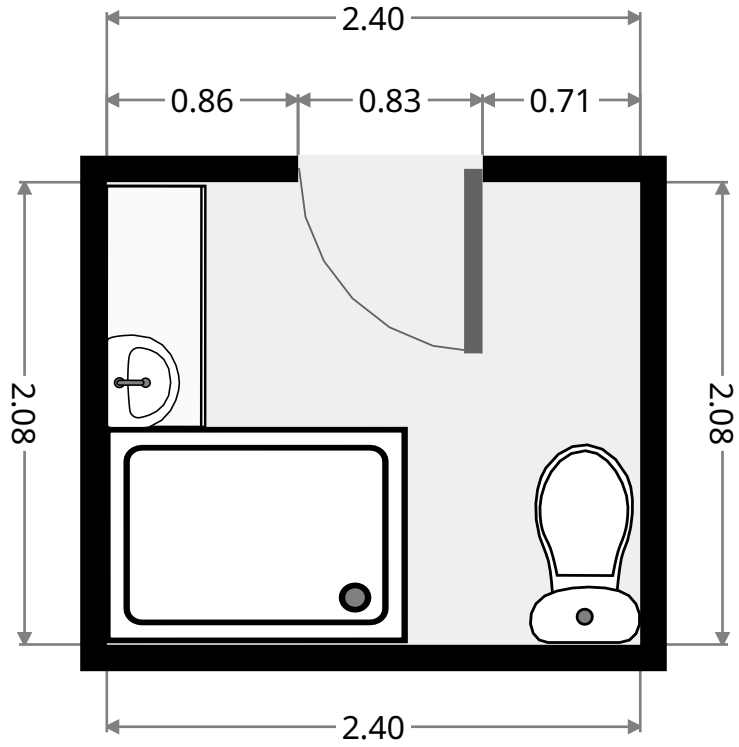
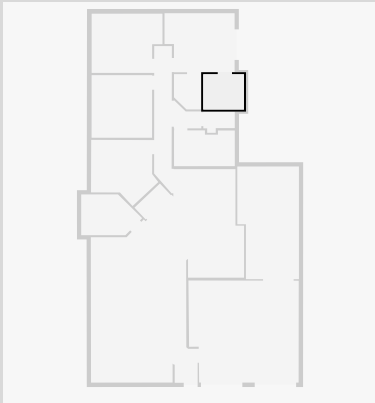

Closet

Width: 1.60 m
Length: 2.08 m
Area: 3.07 m²
Perimeter: 6.94 m

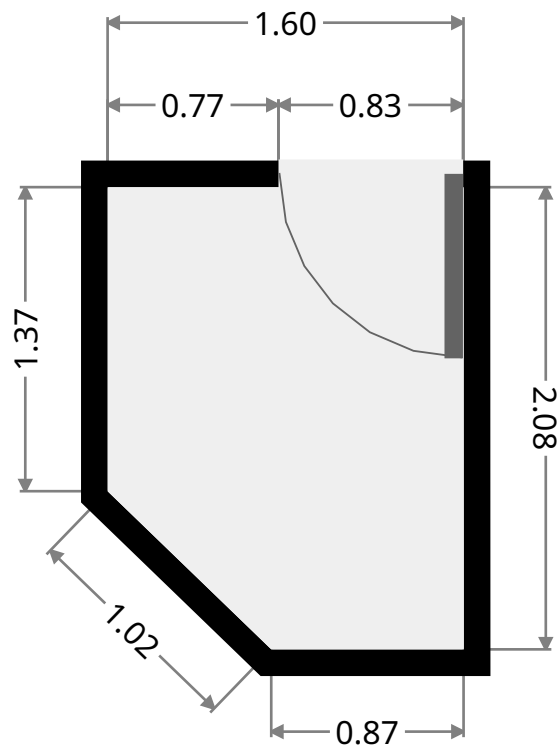
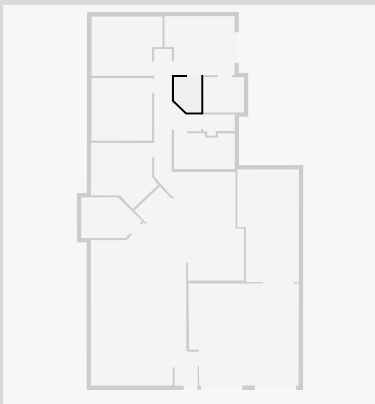

THIS FLOORPLAN IS PROVIDED WITHOUT WARRANTY OF ANY KIND. SENSOPIA DISCLAIMS ANY WARRANTY INCLUDING, WITHOUT LIMITATION, SATISFACTORY QUALITY OR ACCURACY OF DIMENSIONS.

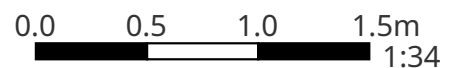

232 German Street

Bedroom

Width: 3.48 m
 Length: 4.13 m
 Area: 13.42 m²
 Perimeter: 15.21 m

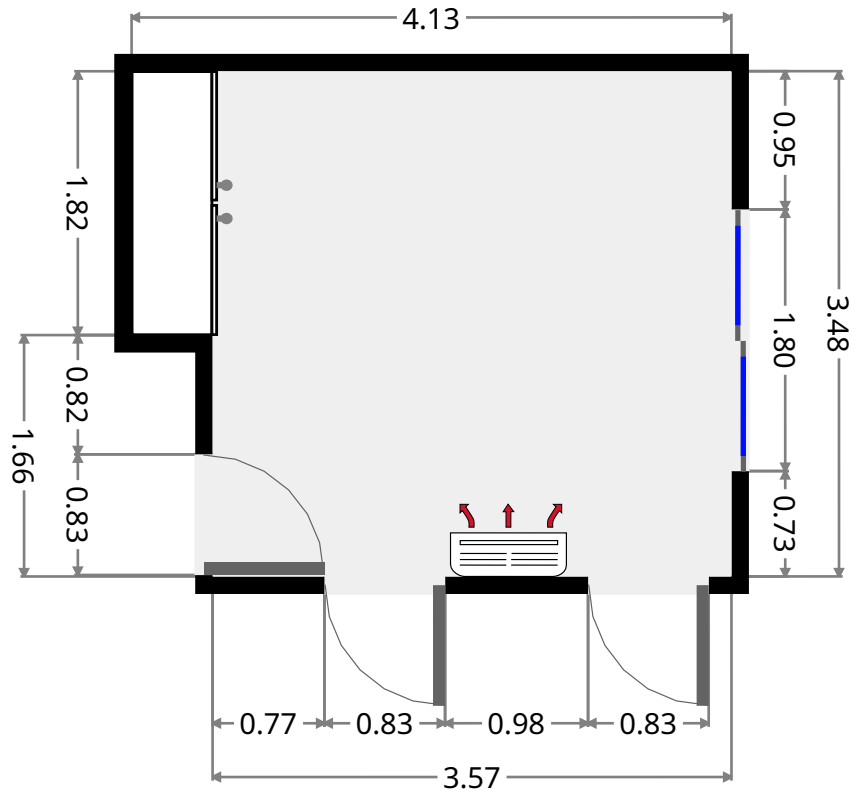
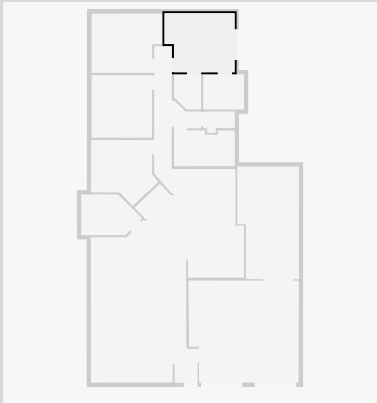

Bedroom

Width: 3.48 m
 Length: 4.17 m
 Area: 13.52 m²
 Perimeter: 15.32 m

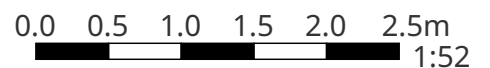
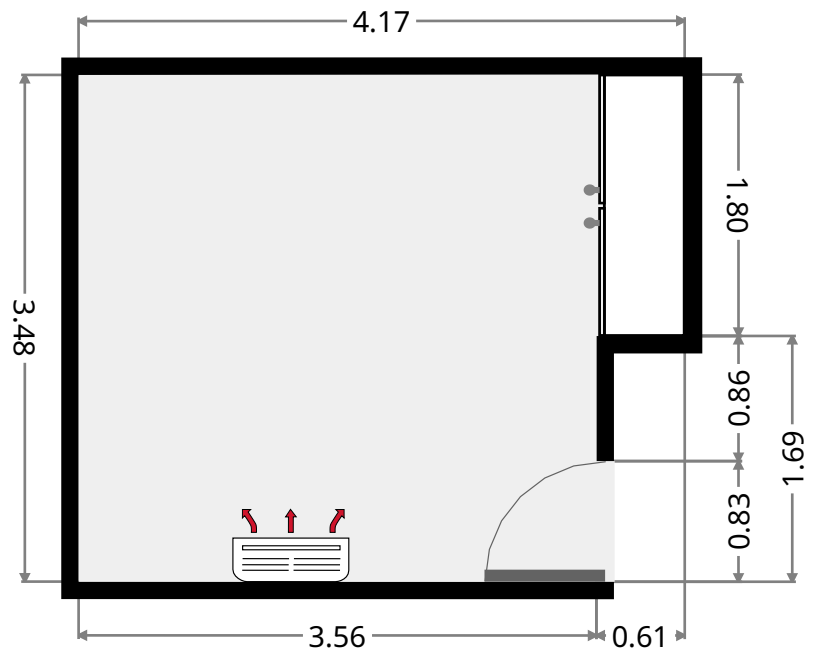
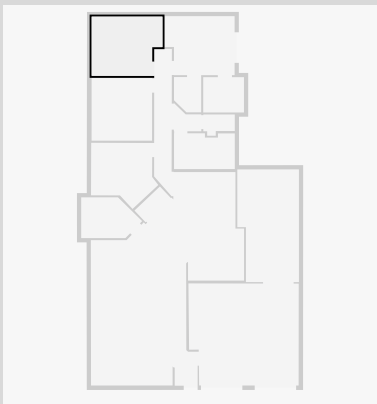

THIS FLOORPLAN IS PROVIDED WITHOUT WARRANTY OF ANY KIND. SENSOPIA DISCLAIMS ANY WARRANTY INCLUDING, WITHOUT LIMITATION, SATISFACTORY QUALITY OR ACCURACY OF DIMENSIONS.

232 German Street

Bedroom

Width: 3.56 m
 Length: 3.68 m
 Area: 13.14 m²
 Perimeter: 14.50 m

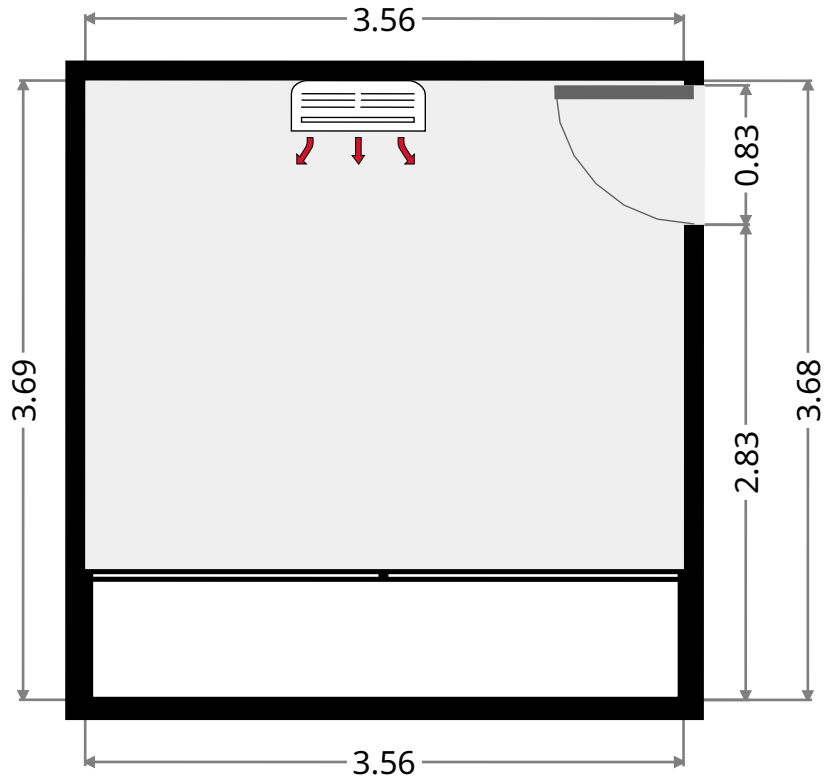
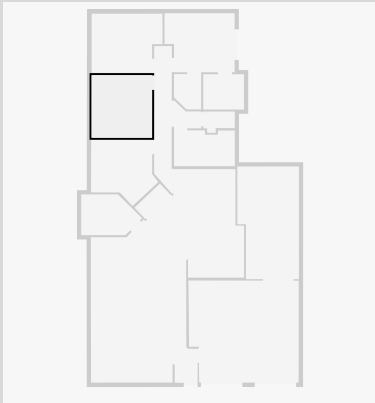

Hall

Width: 1.35 m
 Length: 2.00 m
 Area: 2.37 m²
 Perimeter: 6.23 m

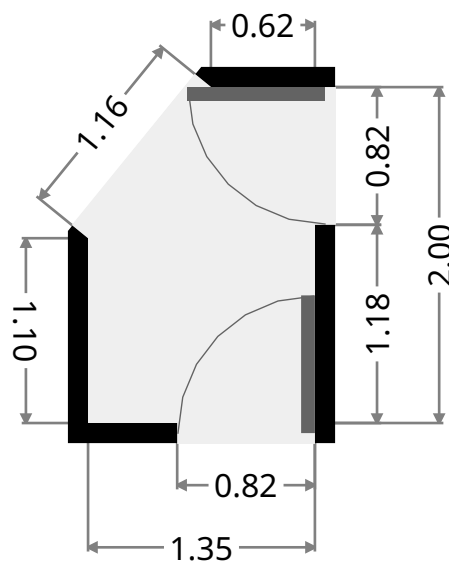
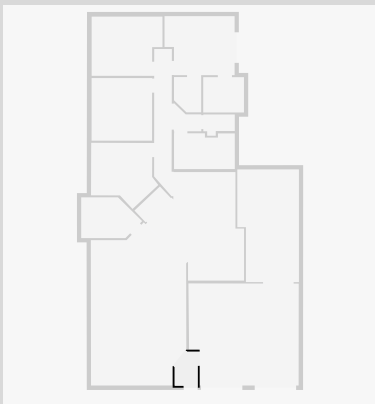

THIS FLOORPLAN IS PROVIDED WITHOUT WARRANTY OF ANY KIND. SENSOPIA DISCLAIMS ANY WARRANTY INCLUDING, WITHOUT LIMITATION, SATISFACTORY QUALITY OR ACCURACY OF DIMENSIONS.

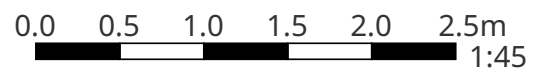

232 German Street

Toilet

Width: 1.25 m
Length: 1.85 m
Area: 1.95 m²
Perimeter: 6.20 m

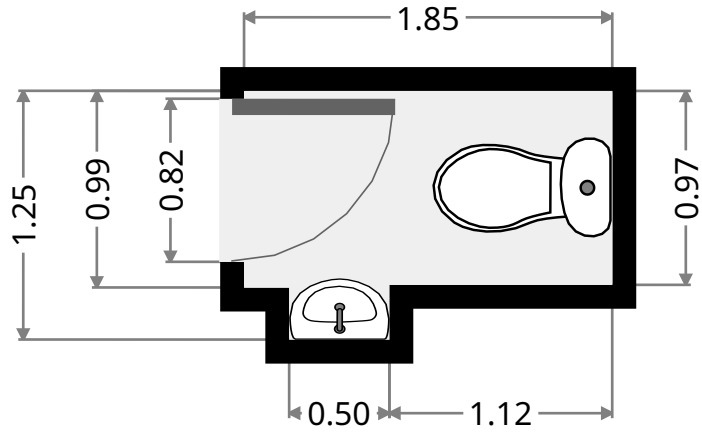
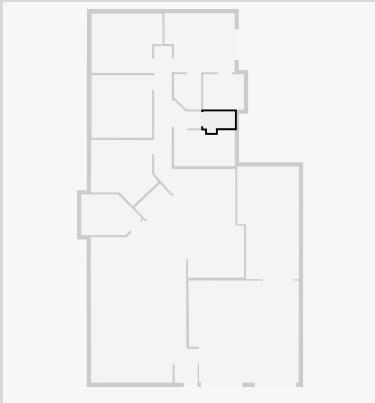

Bathroom

Width: 2.09 m
Length: 3.57 m
Area: 7.34 m²
Perimeter: 11.86 m

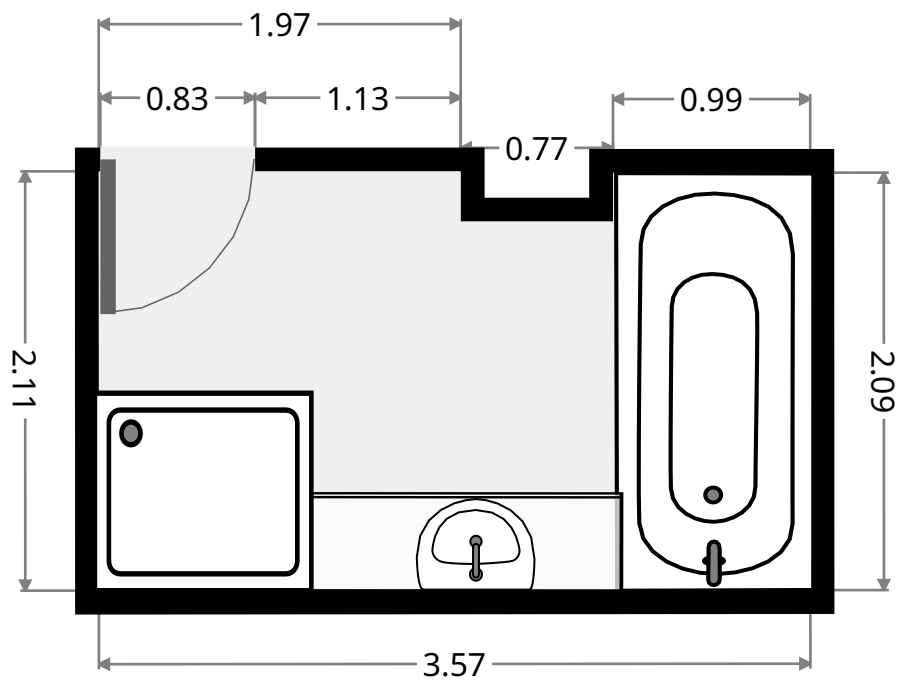
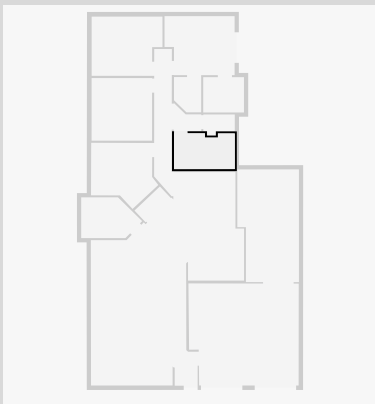

THIS FLOORPLAN IS PROVIDED WITHOUT WARRANTY OF ANY KIND. SENSOPIA DISCLAIMS ANY WARRANTY INCLUDING, WITHOUT LIMITATION, SATISFACTORY QUALITY OR ACCURACY OF DIMENSIONS.

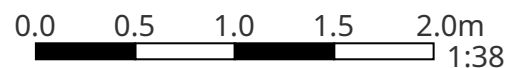

232 German Street

Laundry Room

Width: 0.95 m
Length: 2.06 m
Area: 1.97 m²
Perimeter: 6.03 m

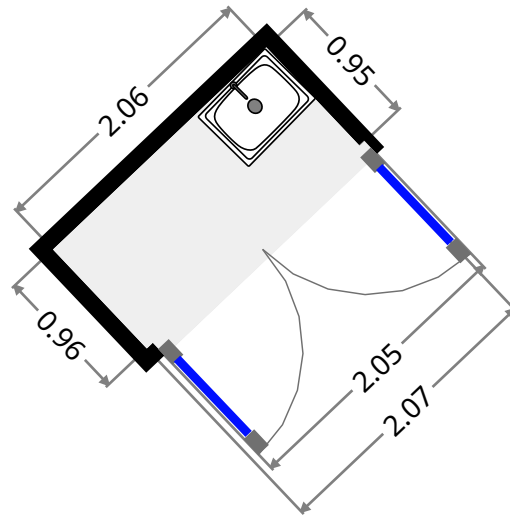
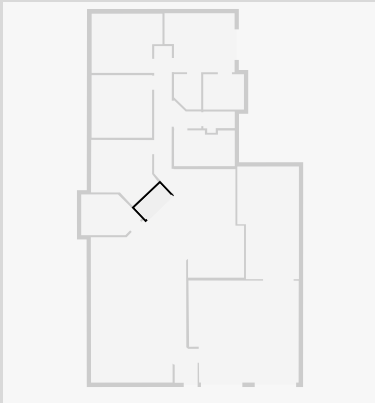

Bedroom

Width: 3.09 m
Length: 3.60 m
Area: 11.86 m²
Perimeter: 14.15 m

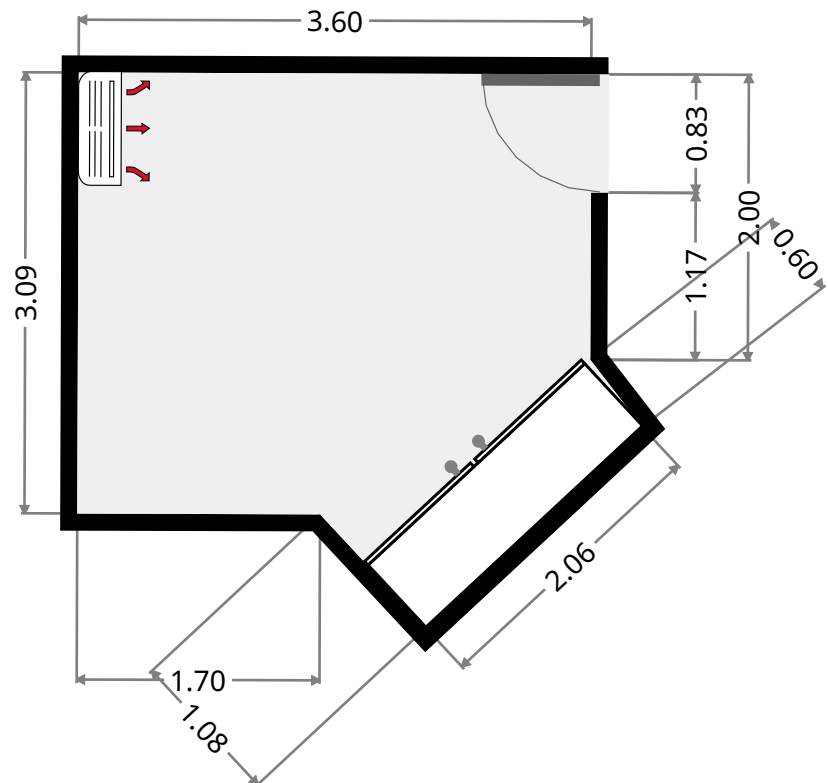
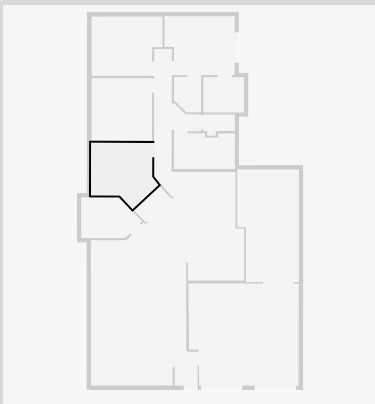

232 German Street

Living Room

Width: 1.04 m
Length: 8.67 m
Area: 8.36 m²
Perimeter: 18.77 m

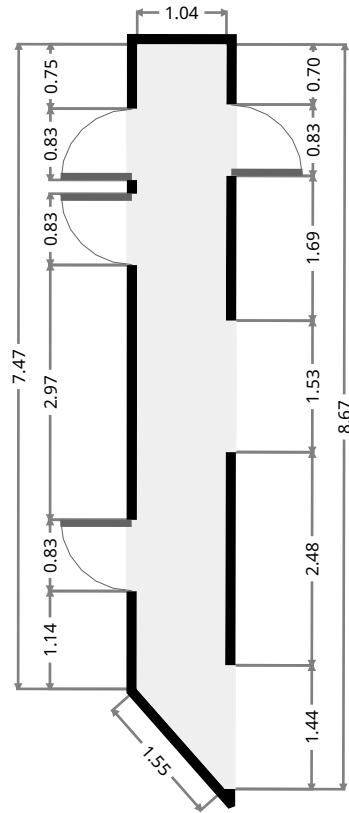
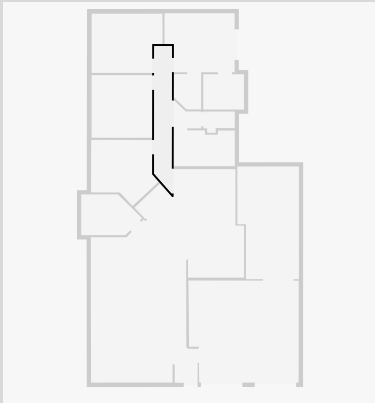

Study

Width: 2.40 m
Length: 2.60 m
Area: 7.13 m²
Perimeter: 10.57 m

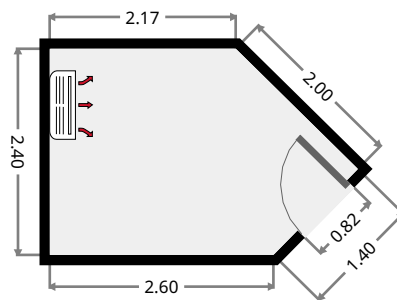
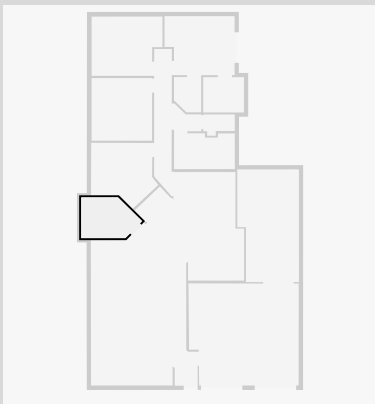

232 German Street

Living Room

Width: 5.61 m
Length: 8.56 m
Area: 46.90 m²
Perimeter: 27.89 m

