

Ground Floor

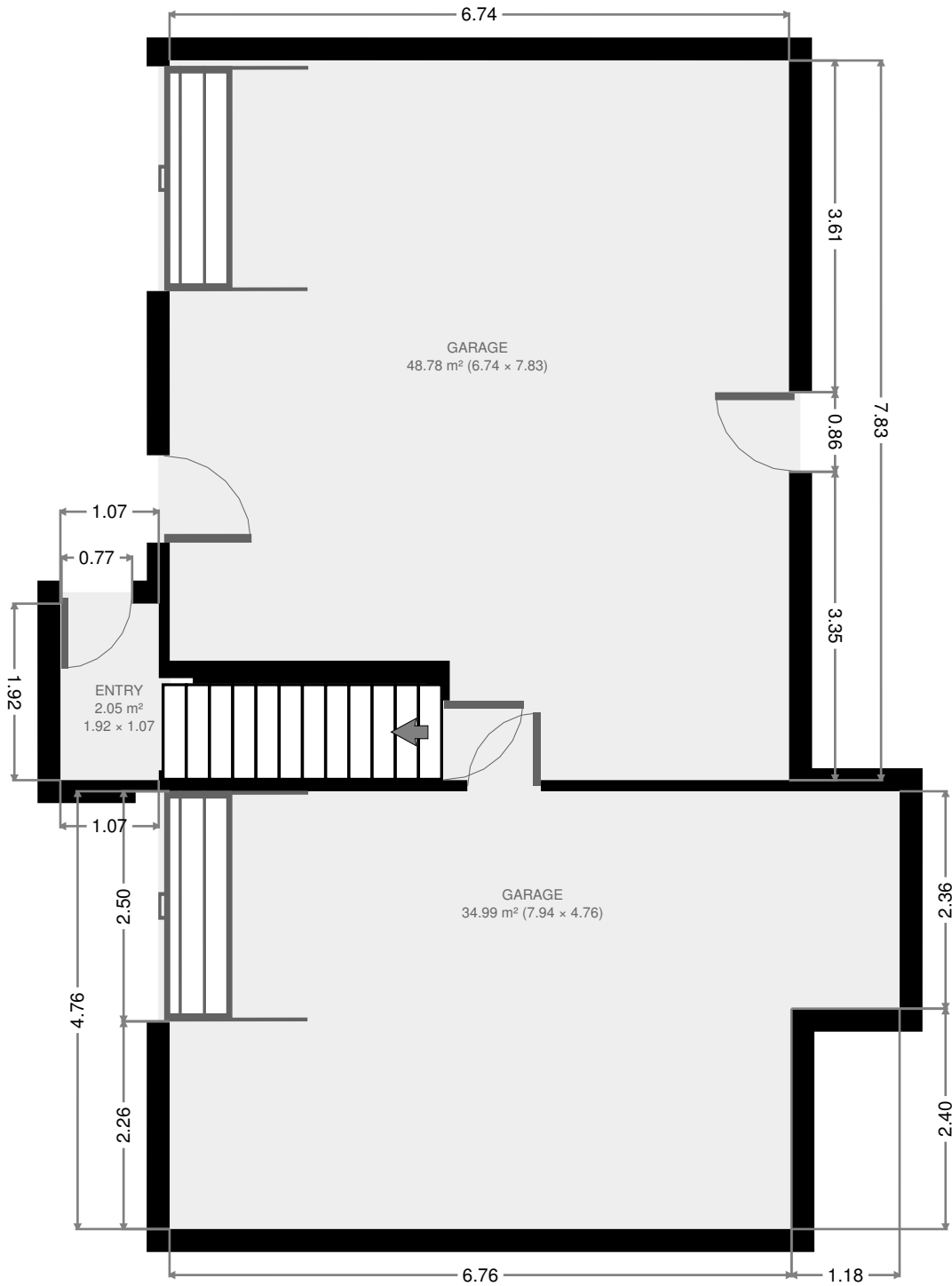

THIS FLOORPLAN IS PROVIDED WITHOUT WARRANTY OF ANY KIND. SENSOPIA DISCLAIMS ANY WARRANTY INCLUDING, WITHOUT LIMITATION, SATISFACTORY QUALITY OR ACCURACY OF DIMENSIONS.

232 Flanagan Street

Garage

Width: 4.76 m
 Length: 7.94 m
 Area: 34.99 m²
 Perimeter: 25.40 m
 Ceiling Height: 2.17 m

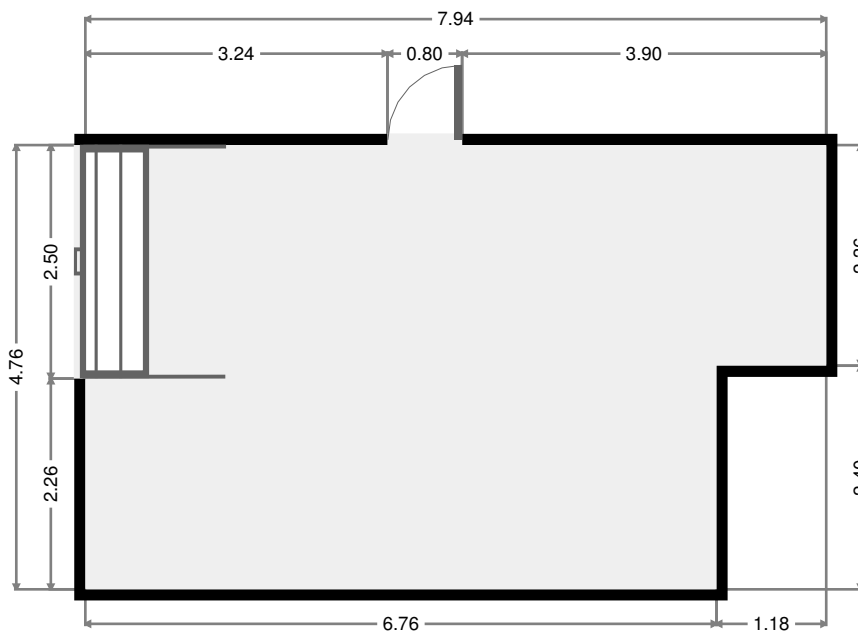
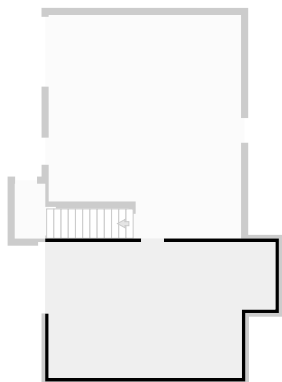

Garage

Width: 6.74 m
 Length: 7.83 m
 Area: 48.78 m²
 Perimeter: 29.13 m
 Ceiling Height: 2.17 m

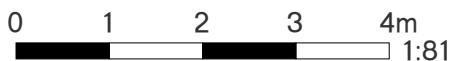
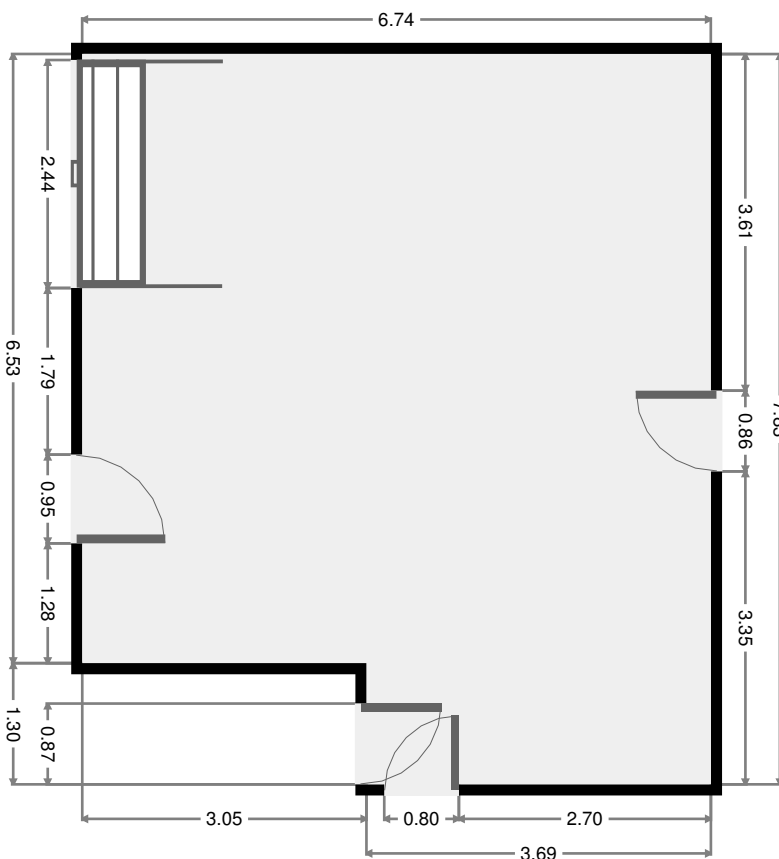
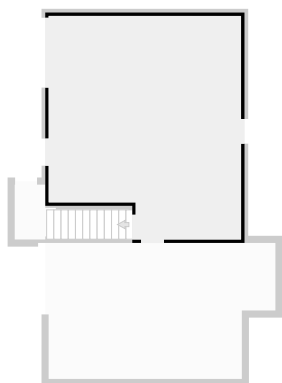

THIS FLOORPLAN IS PROVIDED WITHOUT WARRANTY OF ANY KIND. SENSOPIA DISCLAIMS ANY WARRANTY INCLUDING, WITHOUT LIMITATION, SATISFACTORY QUALITY OR ACCURACY OF DIMENSIONS.

Entry

Width: 1.07 m
Length: 1.92 m
Area: 2.05 m²
Perimeter: 5.98 m

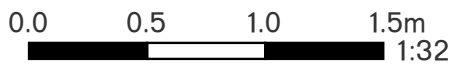
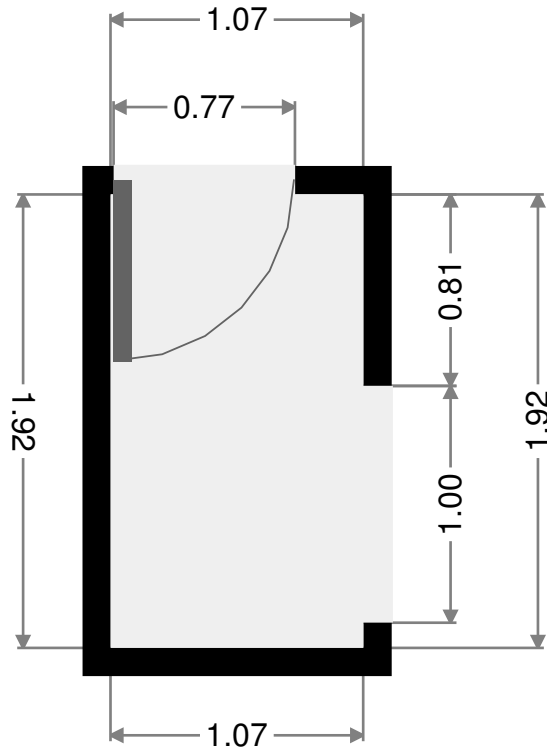
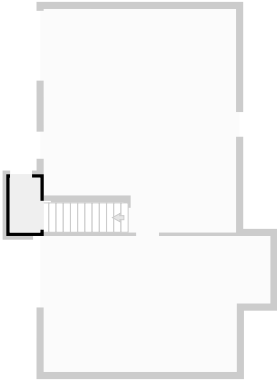

THIS FLOORPLAN IS PROVIDED WITHOUT WARRANTY OF ANY KIND. SENSOPIA DISCLAIMS ANY WARRANTY INCLUDING, WITHOUT LIMITATION, SATISFACTORY QUALITY OR ACCURACY OF DIMENSIONS.

232 Flanagan Street

2017-01-12

1st Floor

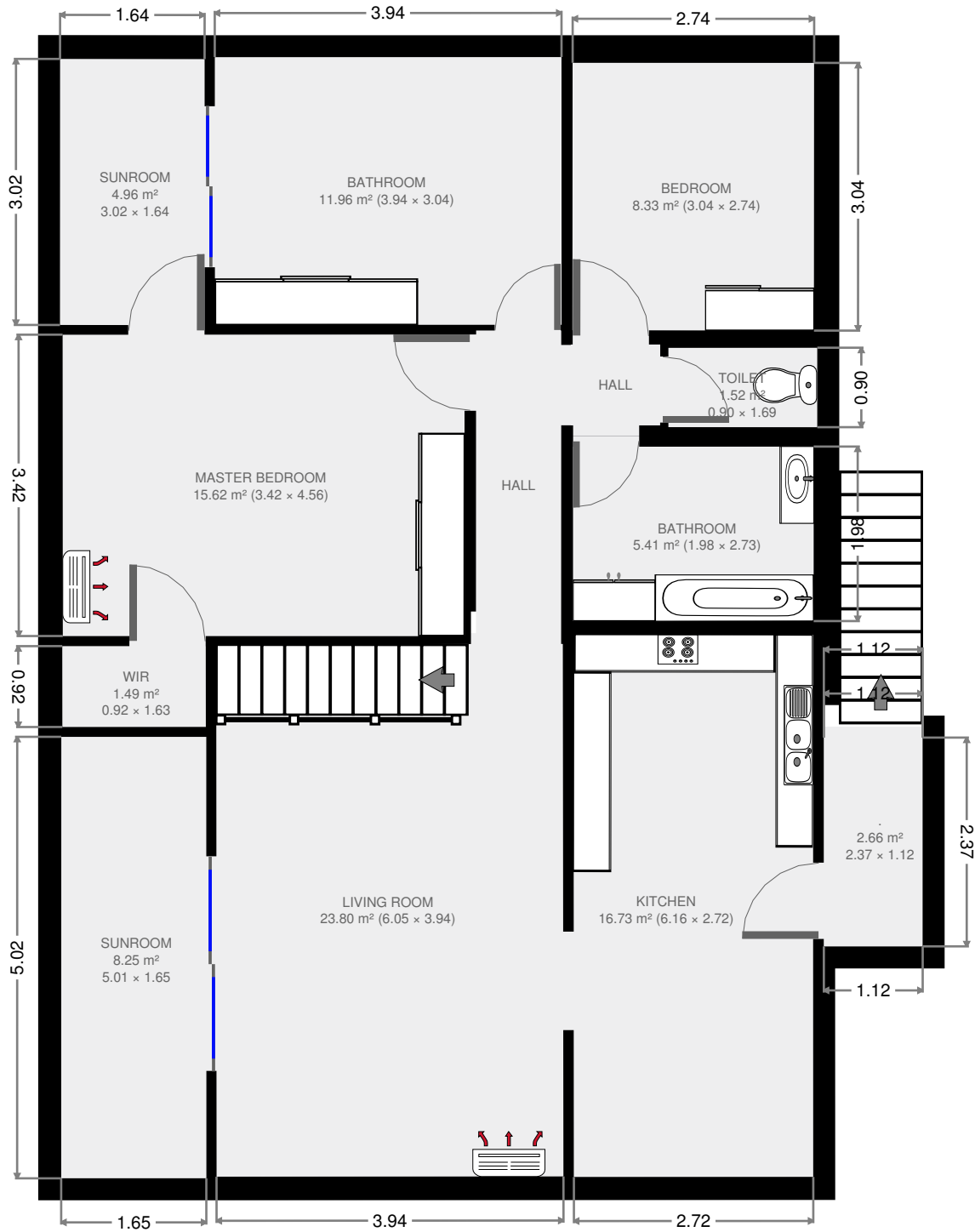

THIS FLOORPLAN IS PROVIDED WITHOUT WARRANTY OF ANY KIND. SENSOPIA DISCLAIMS ANY WARRANTY INCLUDING, WITHOUT LIMITATION, SATISFACTORY QUALITY OR ACCURACY OF DIMENSIONS.

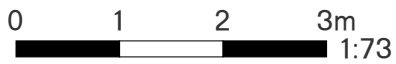

232 Flanagan Street

Sunroom

Width: 1.65 m
 Length: 5.01 m
 Area: 8.25 m²
 Perimeter: 13.32 m

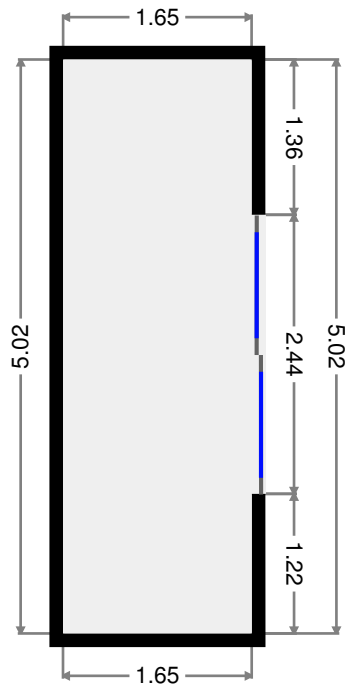
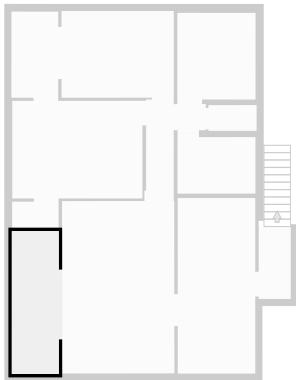

Living Room

Width: 3.94 m
 Length: 6.05 m
 Area: 23.80 m²
 Perimeter: 19.97 m

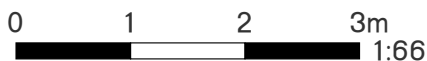
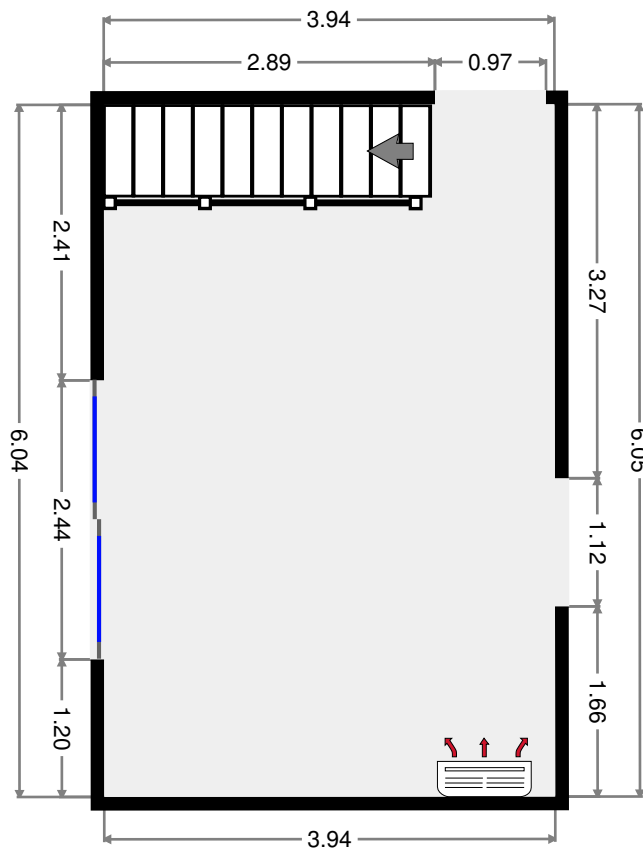
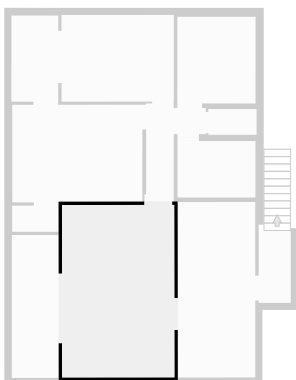

THIS FLOORPLAN IS PROVIDED WITHOUT WARRANTY OF ANY KIND. SENSOPIA DISCLAIMS ANY WARRANTY INCLUDING, WITHOUT LIMITATION, SATISFACTORY QUALITY OR ACCURACY OF DIMENSIONS.

Kitchen

Width: 2.72 m
 Length: 6.16 m
 Area: 16.73 m²
 Perimeter: 17.75 m

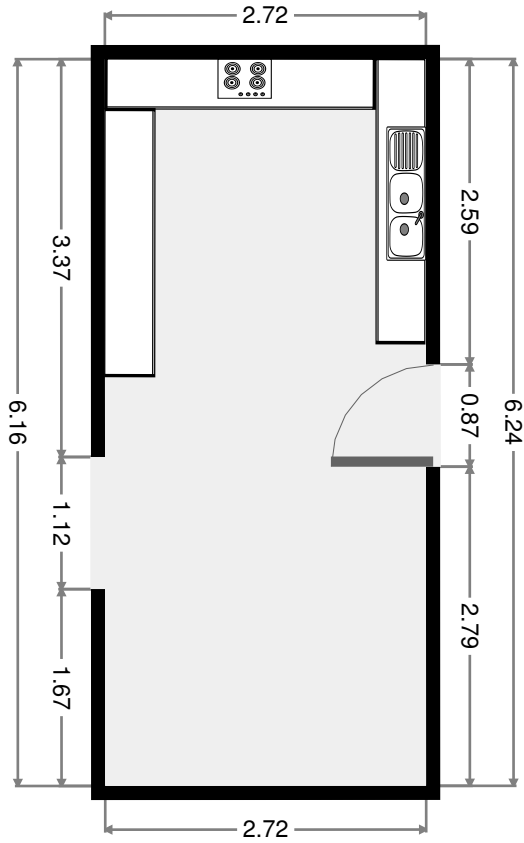
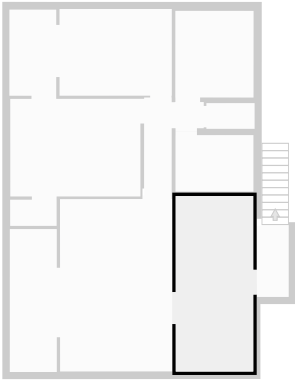

Hall

Width: 0.97 m
 Length: 3.52 m
 Area: 3.40 m²
 Perimeter: 8.97 m

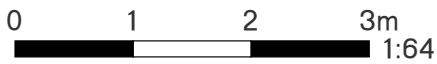
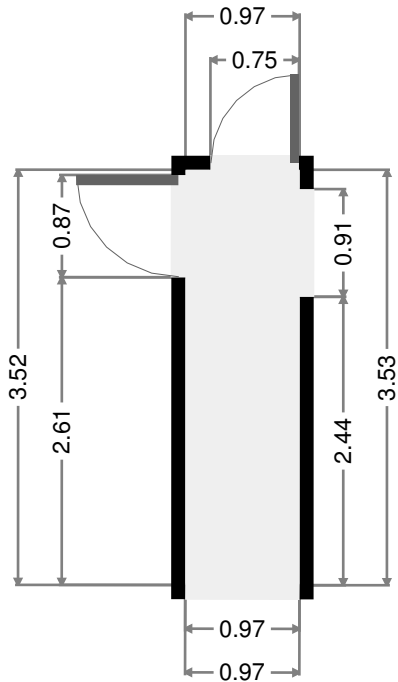
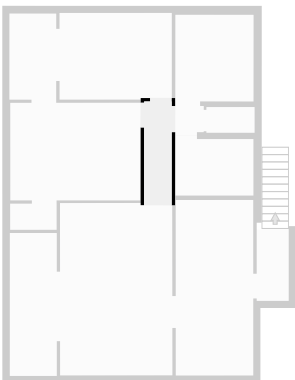

THIS FLOORPLAN IS PROVIDED WITHOUT WARRANTY OF ANY KIND. SENSOPIA DISCLAIMS ANY WARRANTY INCLUDING, WITHOUT LIMITATION, SATISFACTORY QUALITY OR ACCURACY OF DIMENSIONS.

Bathroom

Width: 3.04 m
 Length: 3.94 m
 Area: 11.96 m²
 Perimeter: 13.95 m

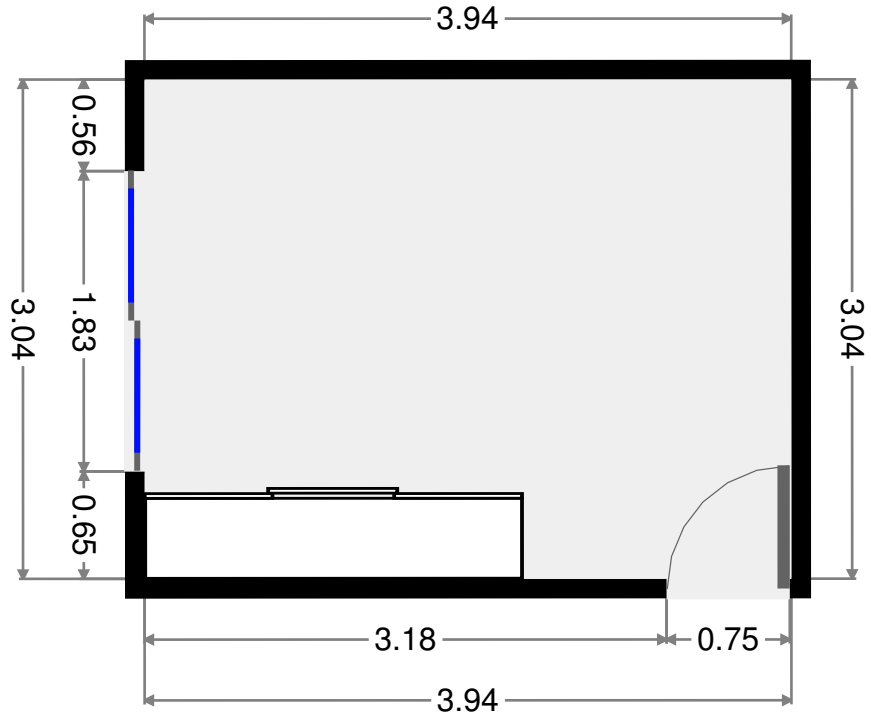
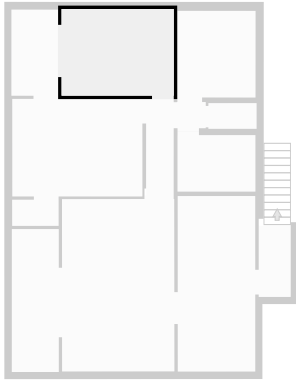

Sunroom

Width: 1.64 m
 Length: 3.02 m
 Area: 4.96 m²
 Perimeter: 9.32 m

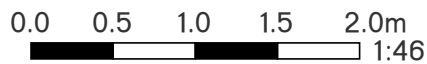
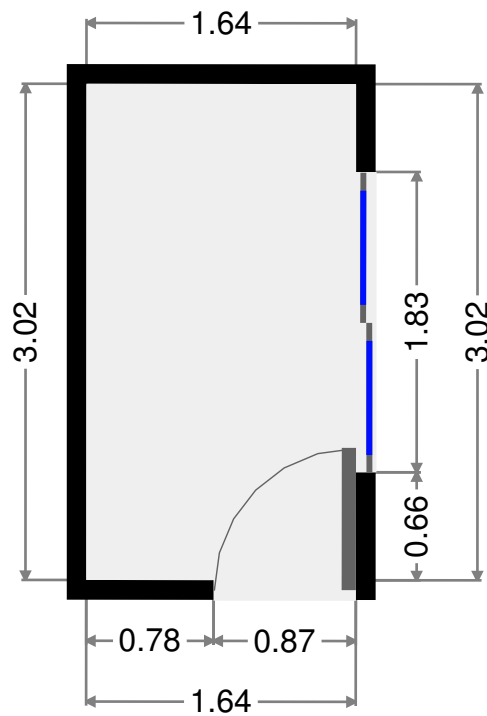
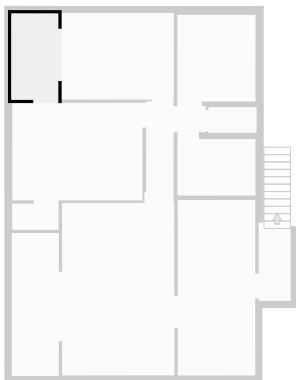

THIS FLOORPLAN IS PROVIDED WITHOUT WARRANTY OF ANY KIND. SENSOPIA DISCLAIMS ANY WARRANTY INCLUDING, WITHOUT LIMITATION, SATISFACTORY QUALITY OR ACCURACY OF DIMENSIONS.

Master Bedroom

Width: 3.42 m
 Length: 4.56 m
 Area: 15.62 m²
 Perimeter: 15.97 m

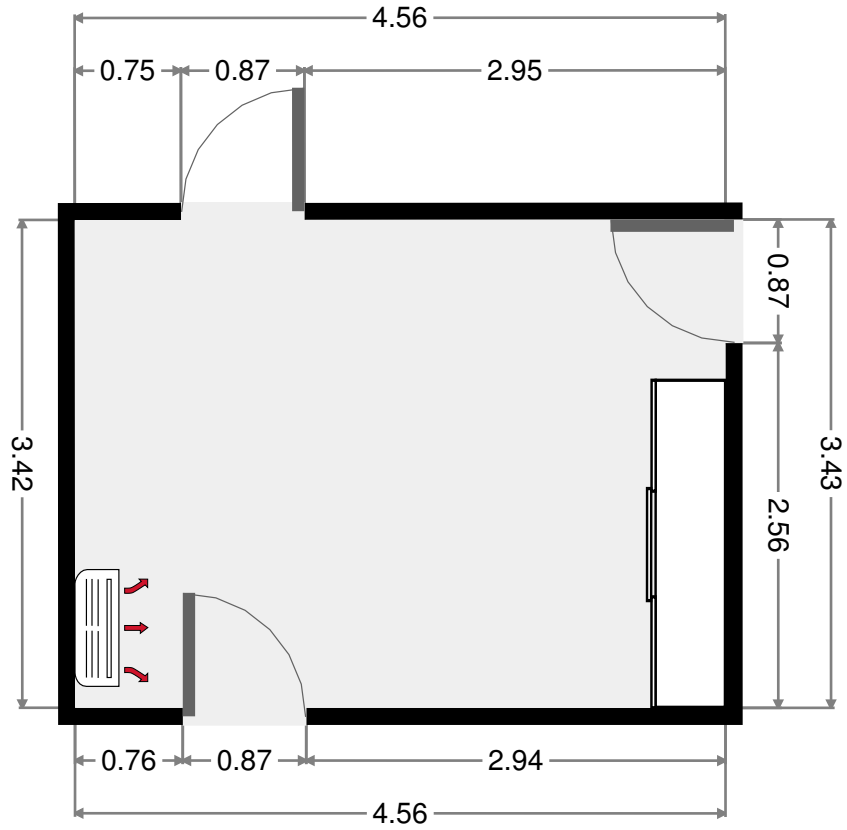
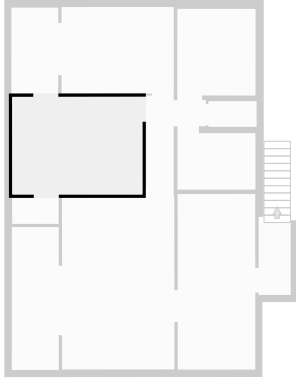

WIR

Width: 0.92 m
 Length: 1.63 m
 Area: 1.49 m²
 Perimeter: 5.09 m

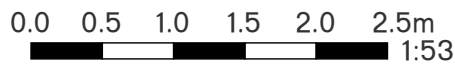
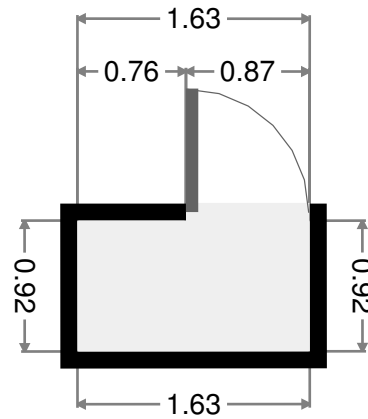
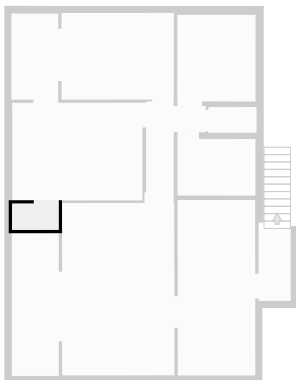

THIS FLOORPLAN IS PROVIDED WITHOUT WARRANTY OF ANY KIND. SENSOPIA DISCLAIMS ANY WARRANTY INCLUDING, WITHOUT LIMITATION, SATISFACTORY QUALITY OR ACCURACY OF DIMENSIONS.

Hall

Width: 0.92 m
 Length: 1.02 m
 Area: 0.93 m²
 Perimeter: 3.87 m

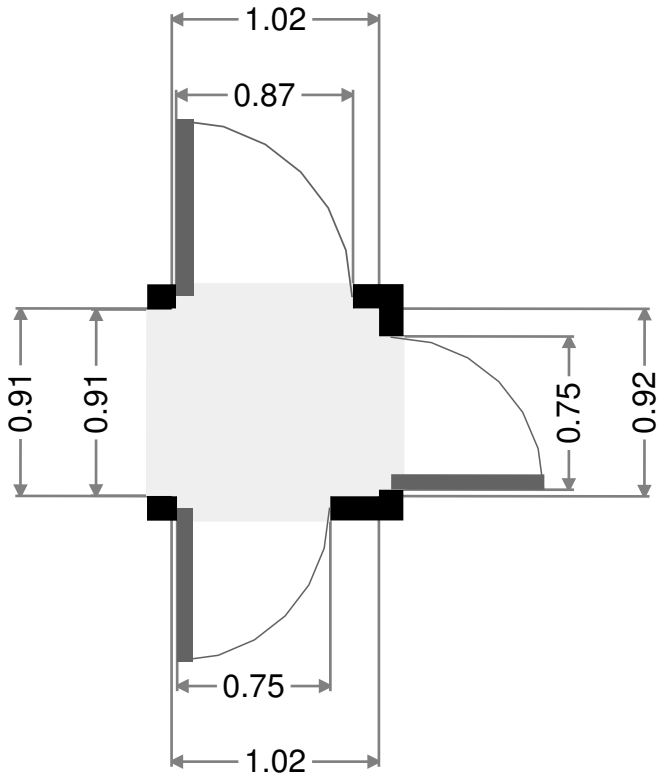
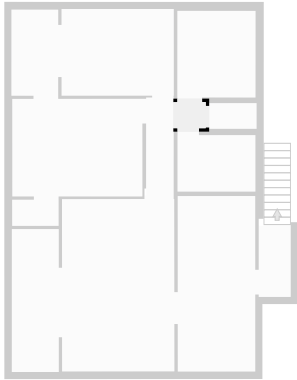

Bathroom

Width: 1.98 m
 Length: 2.73 m
 Area: 5.41 m²
 Perimeter: 9.43 m

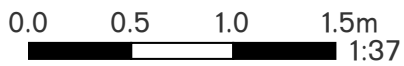
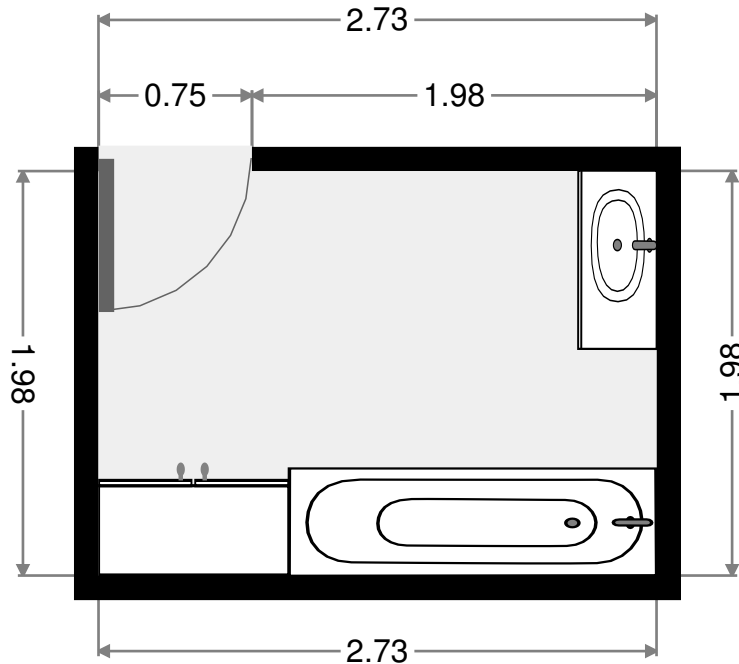
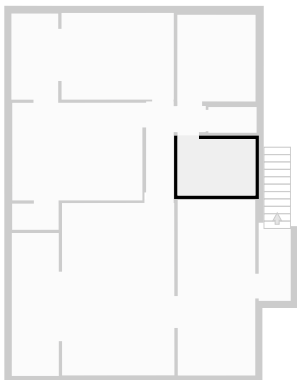

THIS FLOORPLAN IS PROVIDED WITHOUT WARRANTY OF ANY KIND. SENSOPIA DISCLAIMS ANY WARRANTY INCLUDING, WITHOUT LIMITATION, SATISFACTORY QUALITY OR ACCURACY OF DIMENSIONS.

Toilet

Width: 0.90 m
 Length: 1.69 m
 Area: 1.52 m²
 Perimeter: 5.18 m

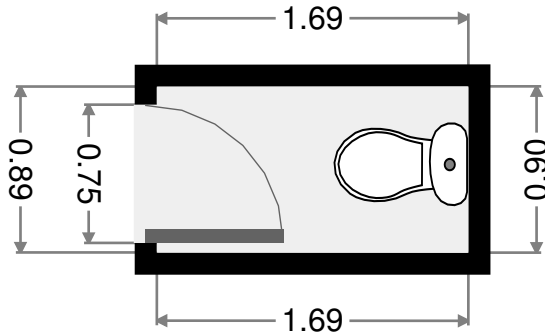
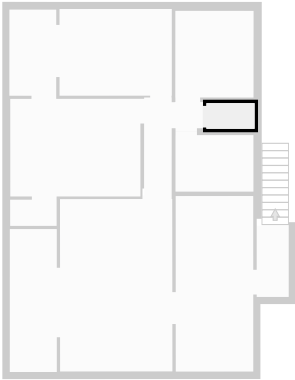

Bedroom

Width: 2.74 m
 Length: 3.04 m
 Area: 8.33 m²
 Perimeter: 11.56 m

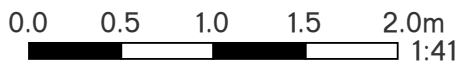
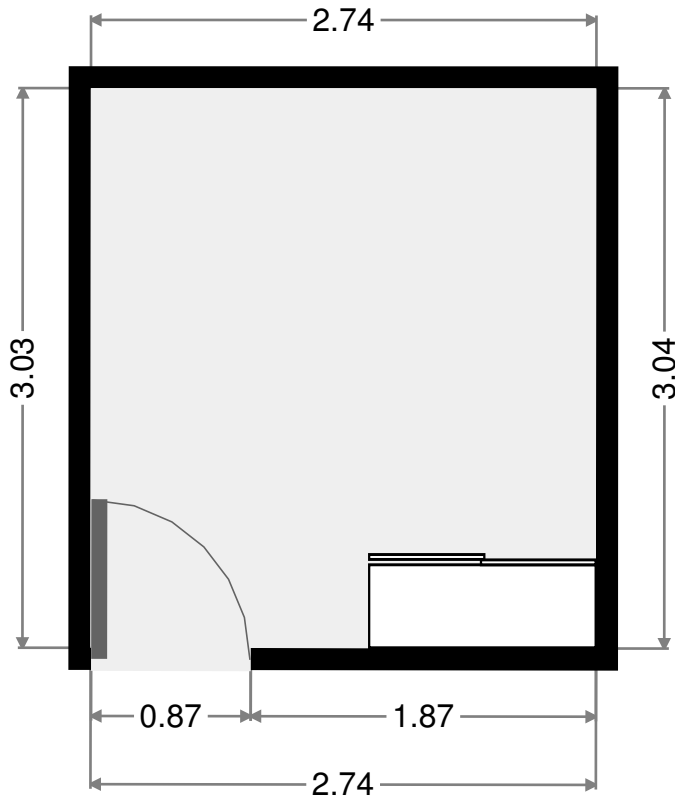
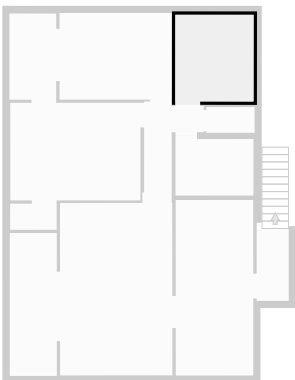

THIS FLOORPLAN IS PROVIDED WITHOUT WARRANTY OF ANY KIND. SENSOPIA DISCLAIMS ANY WARRANTY INCLUDING, WITHOUT LIMITATION, SATISFACTORY QUALITY OR ACCURACY OF DIMENSIONS.

- Width: 1.12 m
 Length: 2.37 m
 Area: 2.66 m²
 Perimeter: 6.98 m

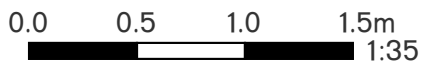
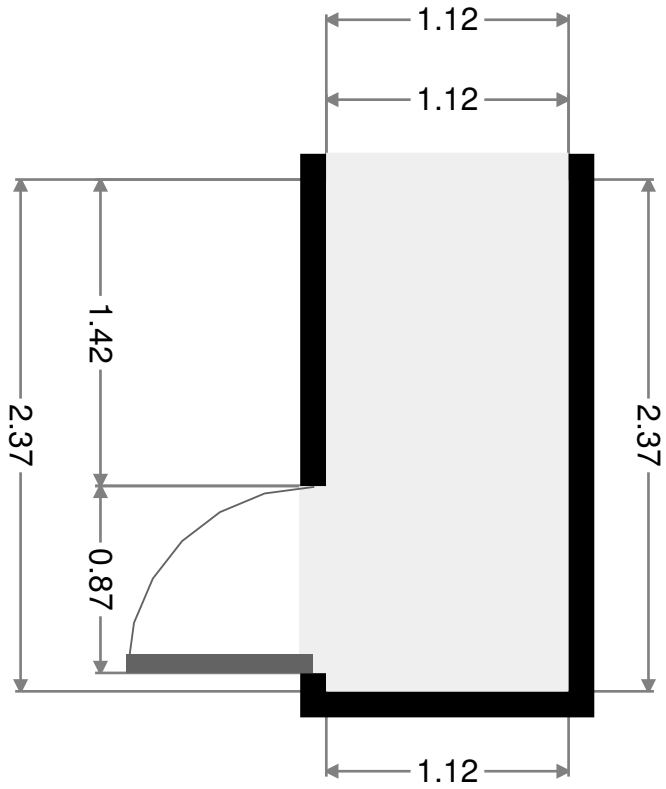
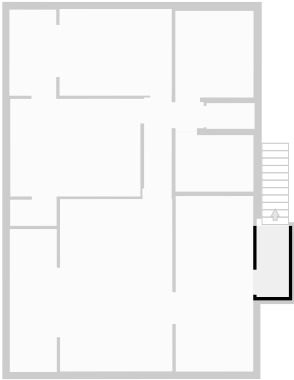

THIS FLOORPLAN IS PROVIDED WITHOUT WARRANTY OF ANY KIND. SENSOPIA DISCLAIMS ANY WARRANTY INCLUDING, WITHOUT LIMITATION, SATISFACTORY QUALITY OR ACCURACY OF DIMENSIONS.

232 Flanagan Street

2017-01-12