

Ground Floor

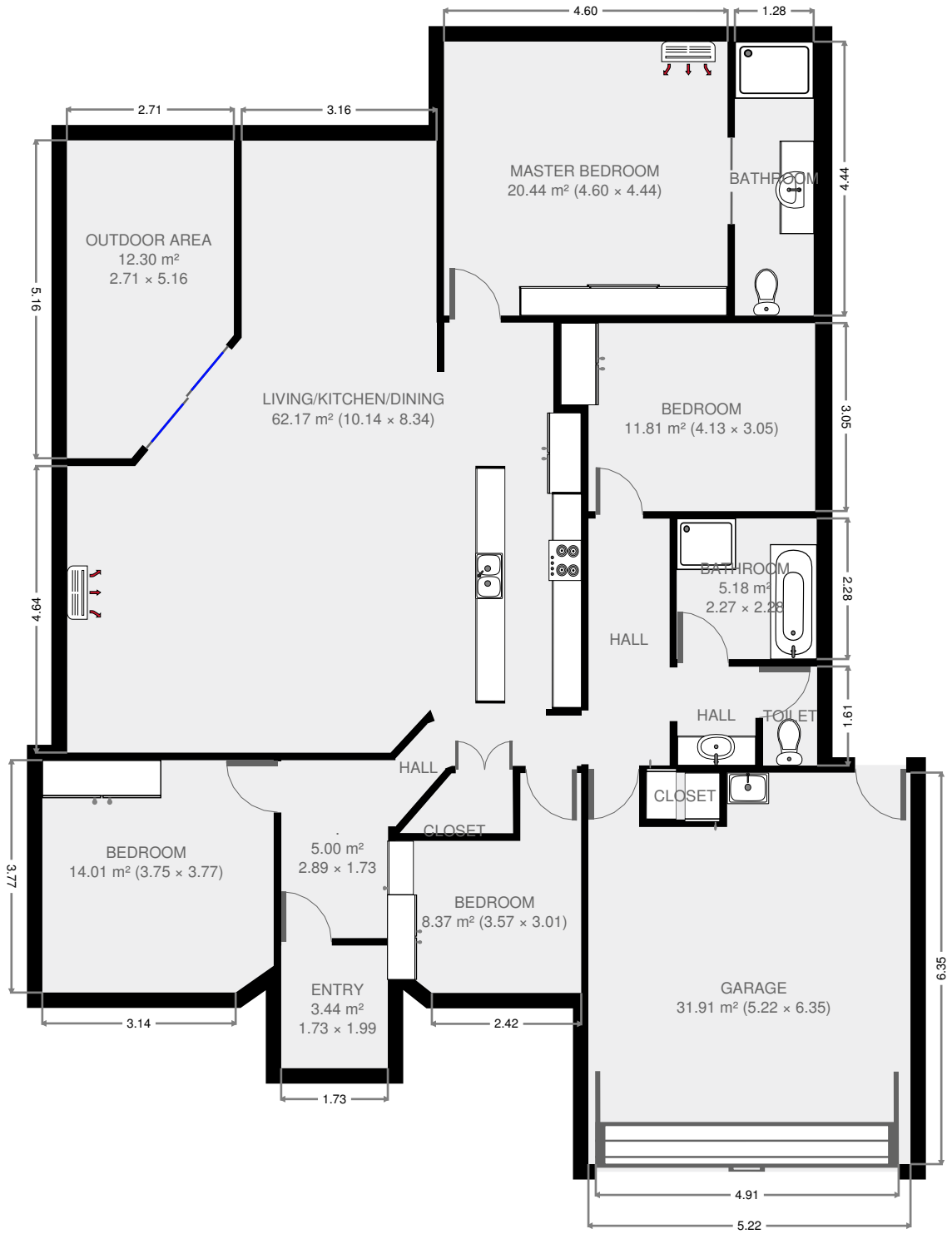

THIS FLOORPLAN IS PROVIDED WITHOUT WARRANTY OF ANY KIND. SENSOPIA DISCLAIMS ANY WARRANTY INCLUDING, WITHOUT LIMITATION, SATISFACTORY QUALITY OR ACCURACY OF DIMENSIONS.



23 Jacaranda Place

Bedroom

Width: 3.05 m
 Length: 4.13 m
 Area: 11.81 m²
 Perimeter: 14.35 m

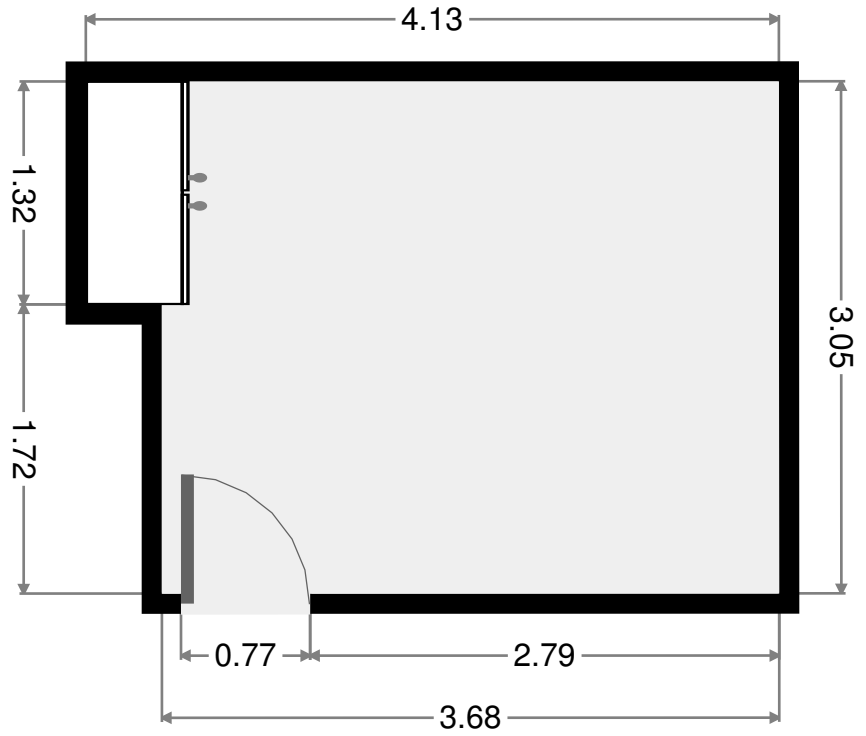
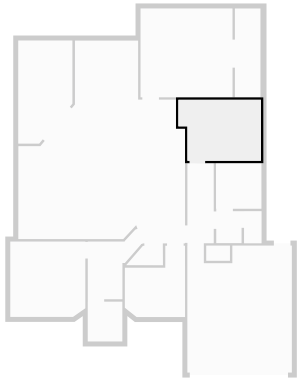

Entry

Width: 1.73 m
 Length: 1.99 m
 Area: 3.44 m²
 Perimeter: 7.44 m

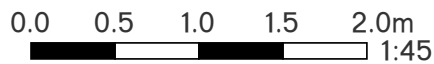
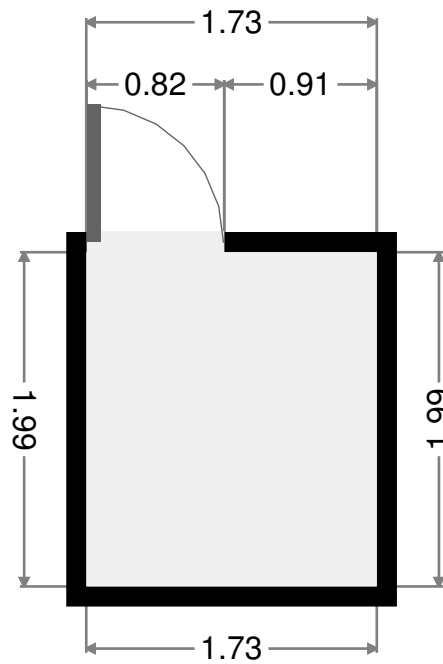
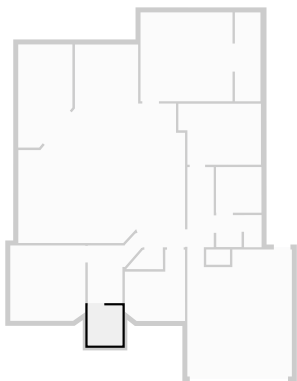

THIS FLOORPLAN IS PROVIDED WITHOUT WARRANTY OF ANY KIND. SENSOPIA DISCLAIMS ANY WARRANTY INCLUDING, WITHOUT LIMITATION, SATISFACTORY QUALITY OR ACCURACY OF DIMENSIONS.

Closet

Width: 0.97 m
 Length: 1.84 m
 Area: 1.37 m²
 Perimeter: 5.08 m

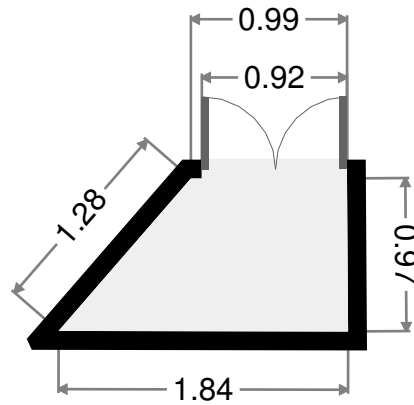
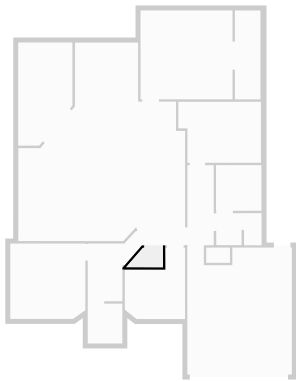

Bedroom

Width: 3.01 m
 Length: 3.57 m
 Area: 8.37 m²
 Perimeter: 12.85 m

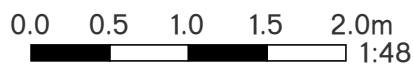
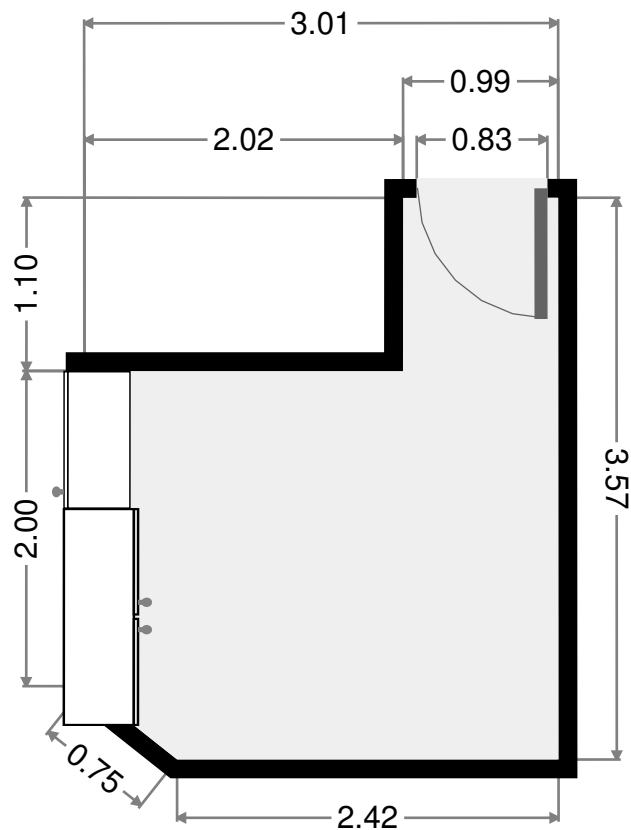
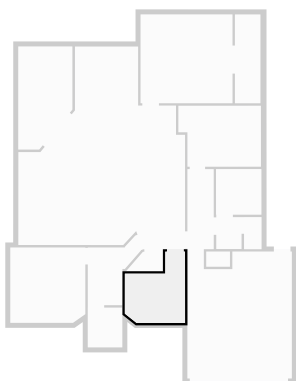

THIS FLOORPLAN IS PROVIDED WITHOUT WARRANTY OF ANY KIND. SENSOPIA DISCLAIMS ANY WARRANTY INCLUDING, WITHOUT LIMITATION, SATISFACTORY QUALITY OR ACCURACY OF DIMENSIONS.

Outdoor Area

Width: 2.71 m
 Length: 5.16 m
 Area: 12.30 m²
 Perimeter: 14.67 m
 Ceiling Height: 2.17 m

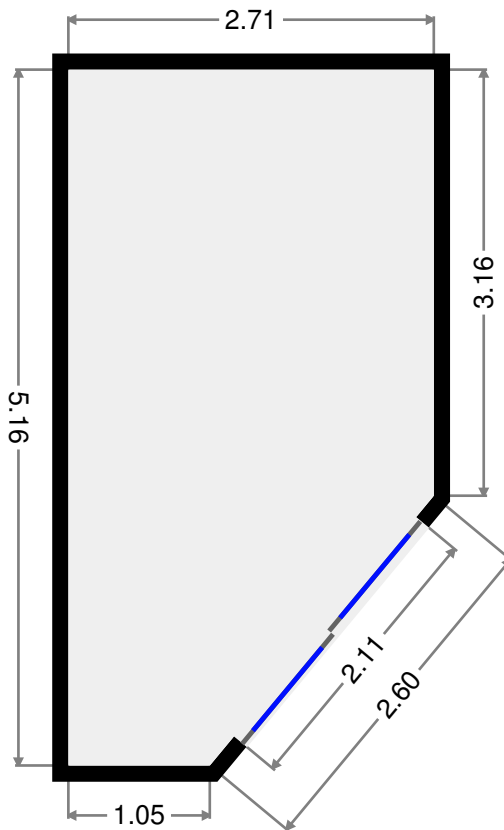
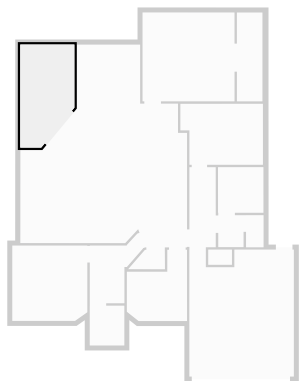

Bathroom

Width: 1.28 m
 Length: 4.44 m
 Area: 5.67 m²
 Perimeter: 11.44 m

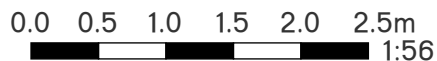
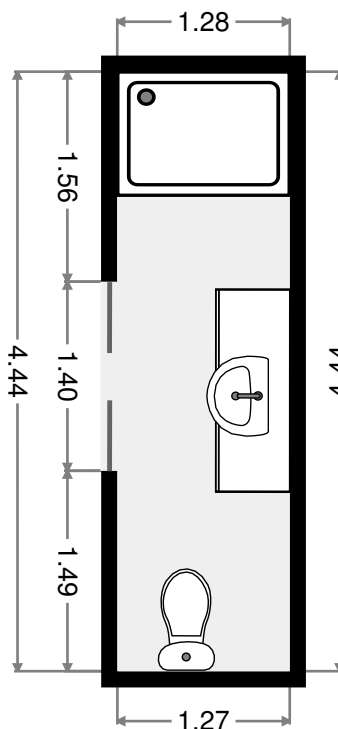
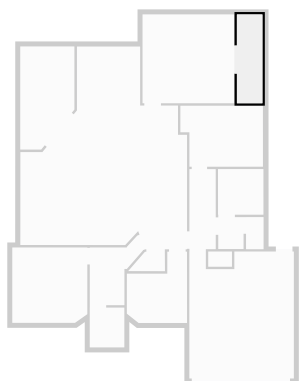

THIS FLOORPLAN IS PROVIDED WITHOUT WARRANTY OF ANY KIND. SENSOPIA DISCLAIMS ANY WARRANTY INCLUDING, WITHOUT LIMITATION, SATISFACTORY QUALITY OR ACCURACY OF DIMENSIONS.

Master Bedroom

Width: 4.44 m
 Length: 4.60 m
 Area: 20.44 m²
 Perimeter: 18.09 m

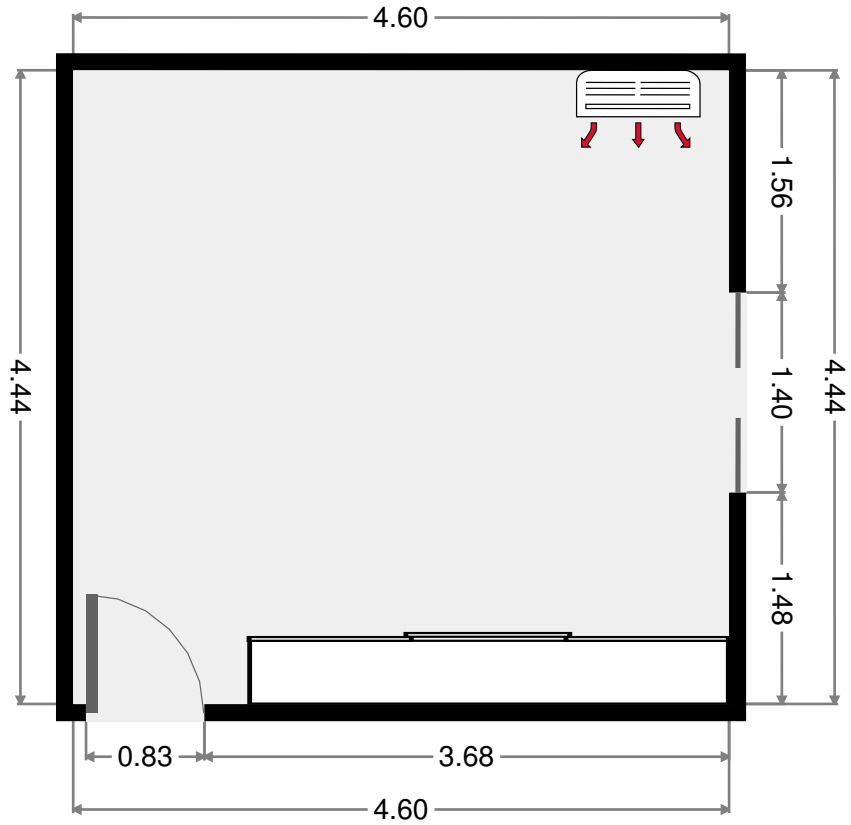
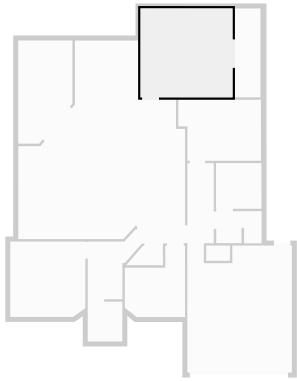

Closet

Width: 0.76 m
 Length: 1.19 m
 Area: 0.90 m²
 Perimeter: 3.89 m

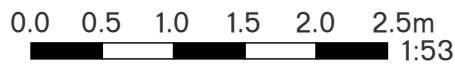
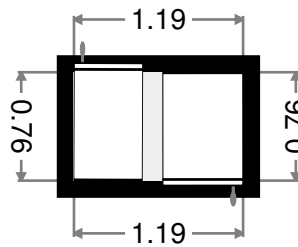
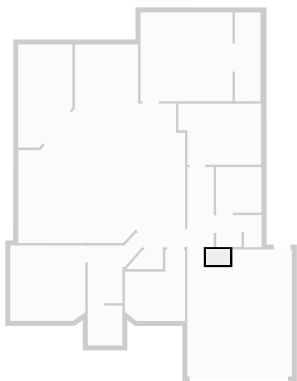

THIS FLOORPLAN IS PROVIDED WITHOUT WARRANTY OF ANY KIND. SENSOPIA DISCLAIMS ANY WARRANTY INCLUDING, WITHOUT LIMITATION, SATISFACTORY QUALITY OR ACCURACY OF DIMENSIONS.

Garage

Width: 5.22 m
 Length: 6.35 m
 Area: 31.91 m²
 Perimeter: 24.90 m

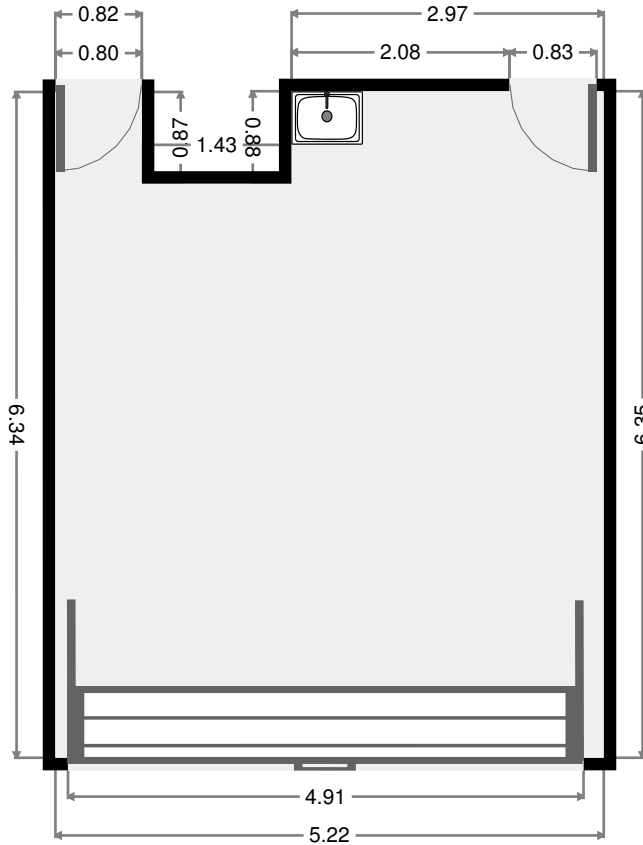
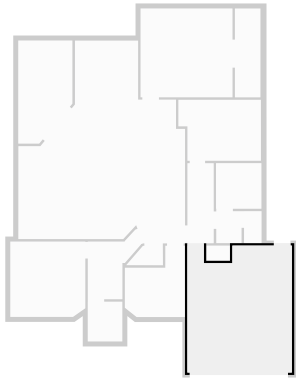

Width: 1.73 m
 Length: 2.89 m
 Area: 5.00 m²
 Perimeter: 9.24 m

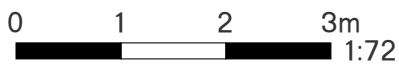
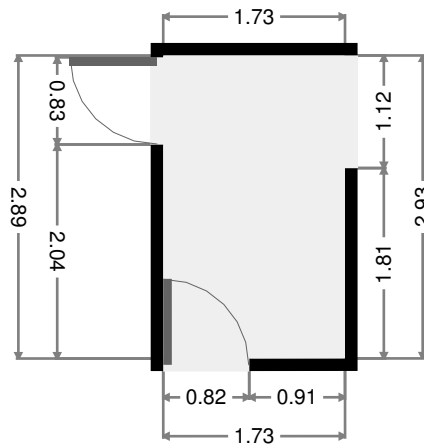
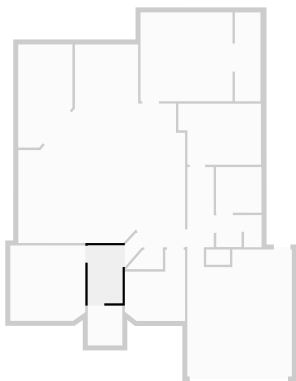

THIS FLOORPLAN IS PROVIDED WITHOUT WARRANTY OF ANY KIND. SENSOPIA DISCLAIMS ANY WARRANTY INCLUDING, WITHOUT LIMITATION, SATISFACTORY QUALITY OR ACCURACY OF DIMENSIONS.

Bathroom

Width: 2.27 m
 Length: 2.28 m
 Area: 5.18 m²
 Perimeter: 9.10 m

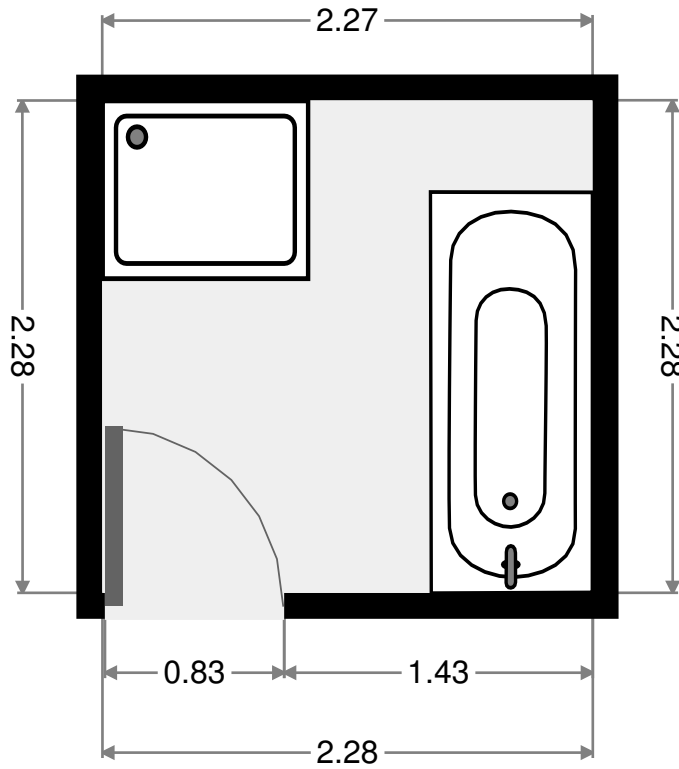
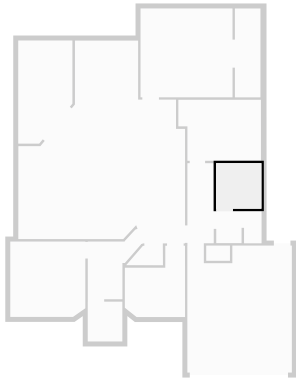

Toilet

Width: 0.88 m
 Length: 1.61 m
 Area: 1.41 m²
 Perimeter: 4.96 m

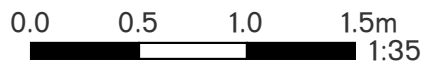
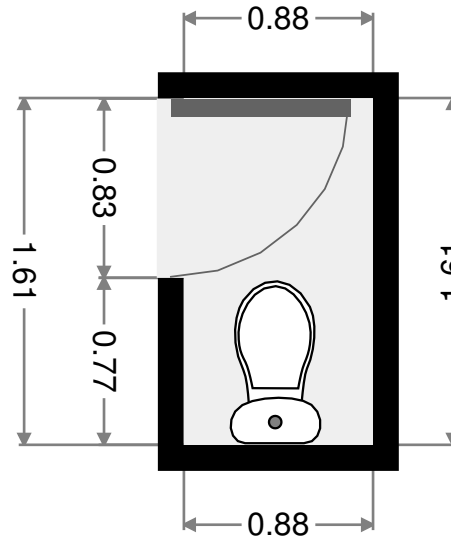
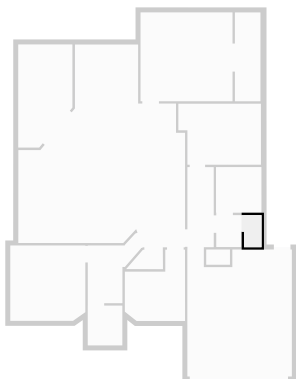

THIS FLOORPLAN IS PROVIDED WITHOUT WARRANTY OF ANY KIND. SENSOPIA DISCLAIMS ANY WARRANTY INCLUDING, WITHOUT LIMITATION, SATISFACTORY QUALITY OR ACCURACY OF DIMENSIONS.

Hall

Width: 1.26 m
 Length: 1.60 m
 Area: 2.02 m²
 Perimeter: 5.72 m

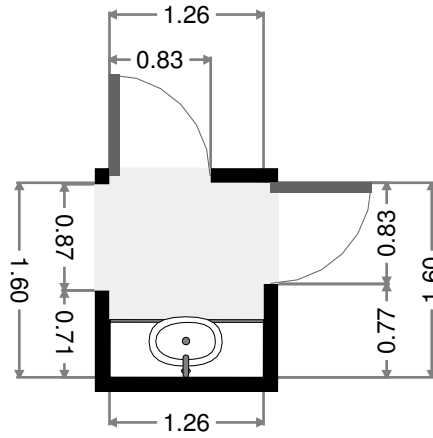
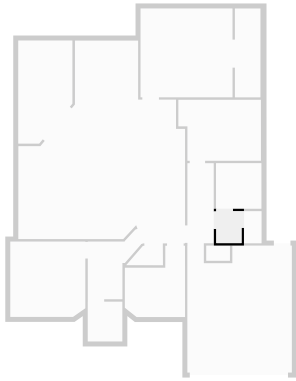

Hall

Width: 1.31 m
 Length: 4.00 m
 Area: 5.26 m²
 Perimeter: 10.64 m

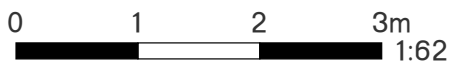
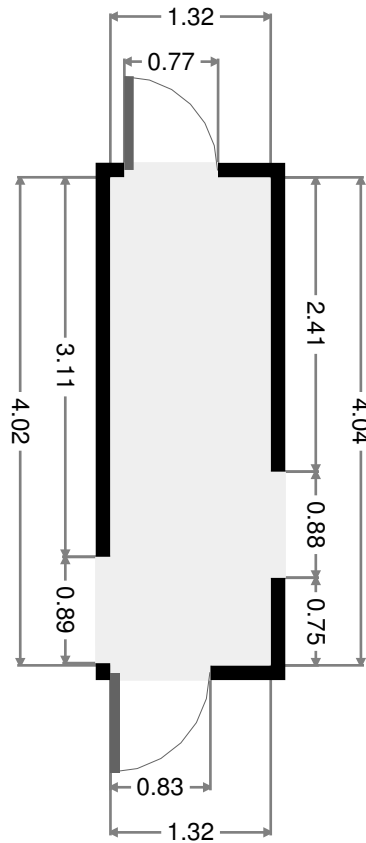
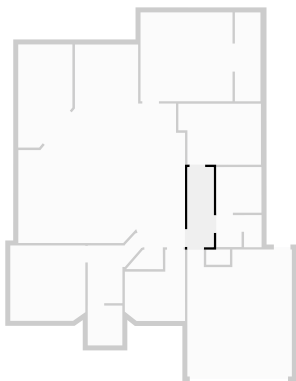

THIS FLOORPLAN IS PROVIDED WITHOUT WARRANTY OF ANY KIND. SENSOPIA DISCLAIMS ANY WARRANTY INCLUDING, WITHOUT LIMITATION, SATISFACTORY QUALITY OR ACCURACY OF DIMENSIONS.

Living/Kitchen/Dining

Width: 8.34 m
 Length: 10.14 m
 Area: 62.17 m²
 Perimeter: 36.57 m
 Ceiling Height: 2.17 m

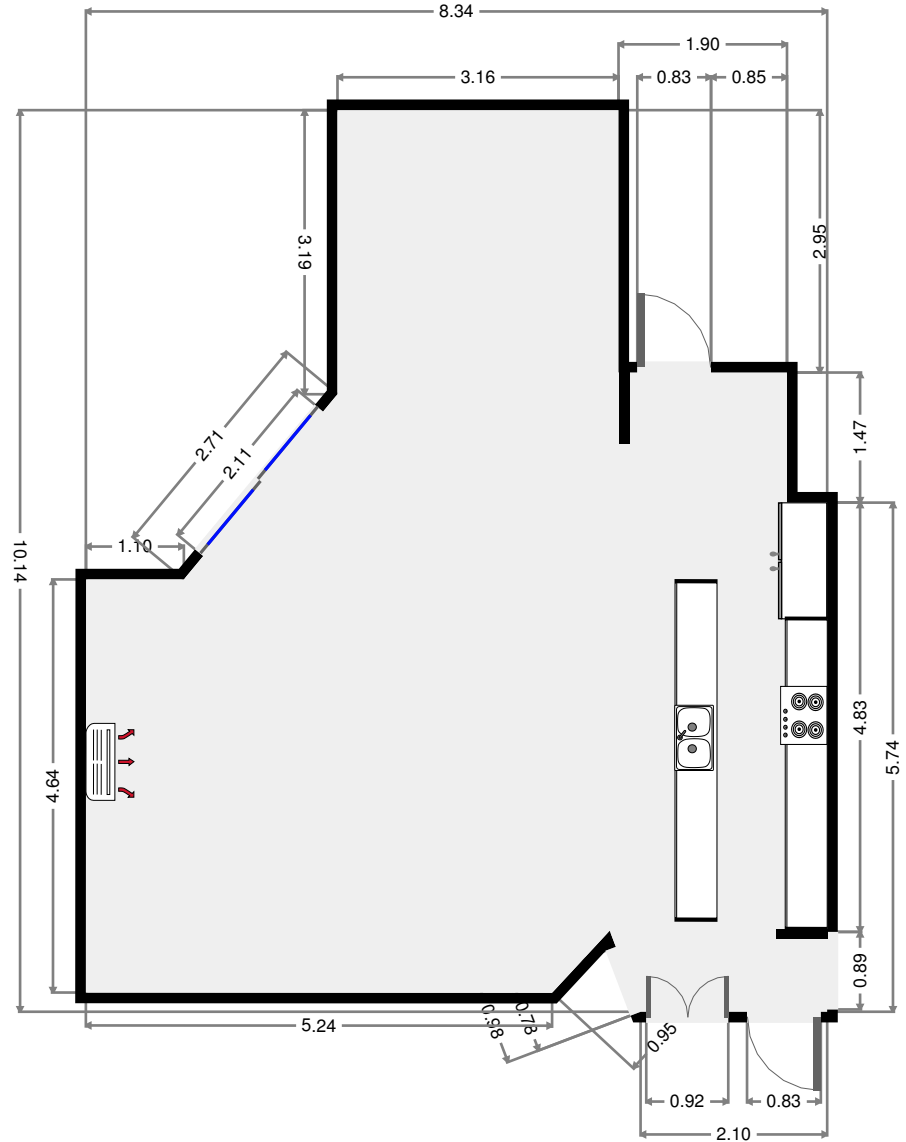
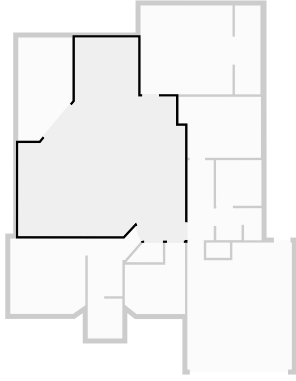

THIS FLOORPLAN IS PROVIDED WITHOUT WARRANTY OF ANY KIND. SENSOPIA DISCLAIMS ANY WARRANTY INCLUDING, WITHOUT LIMITATION, SATISFACTORY QUALITY OR ACCURACY OF DIMENSIONS.

Hall

Width: 0.72 m
 Length: 1.60 m
 Area: 0.72 m²
 Perimeter: 3.90 m

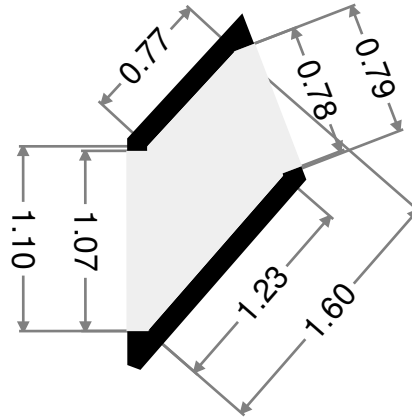

Bedroom

Width: 3.75 m
 Length: 3.77 m
 Area: 14.01 m²
 Perimeter: 14.75 m

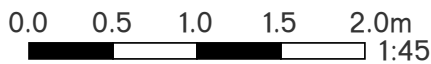
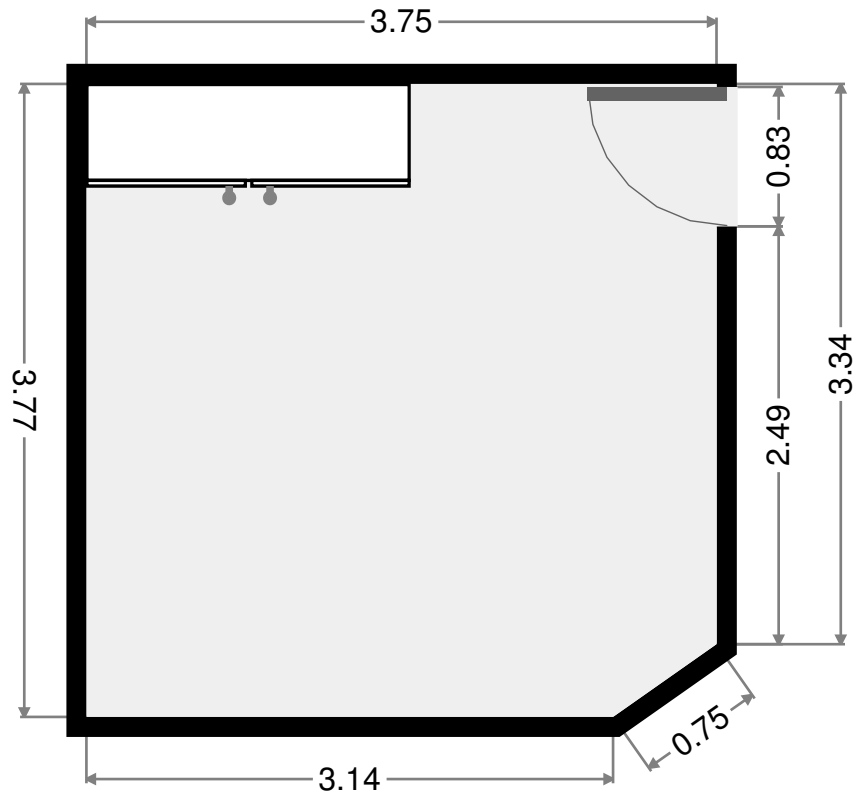
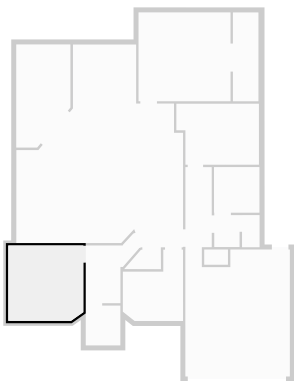

THIS FLOORPLAN IS PROVIDED WITHOUT WARRANTY OF ANY KIND. SENSOPIA DISCLAIMS ANY WARRANTY INCLUDING, WITHOUT LIMITATION, SATISFACTORY QUALITY OR ACCURACY OF DIMENSIONS.