

23 Harris Crescent

Created on
2021-07-26

Floors
1

▼ Ground Floor

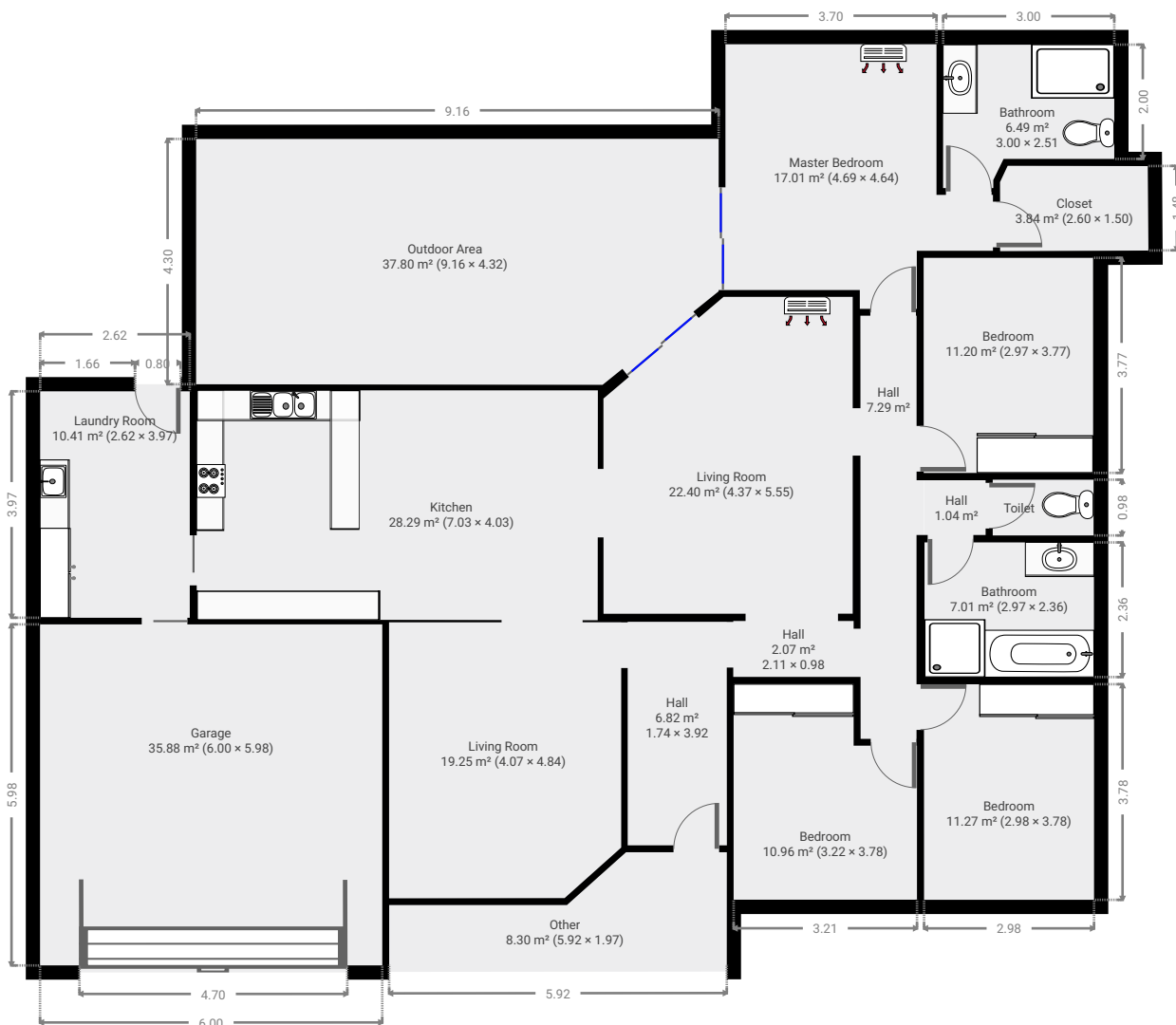
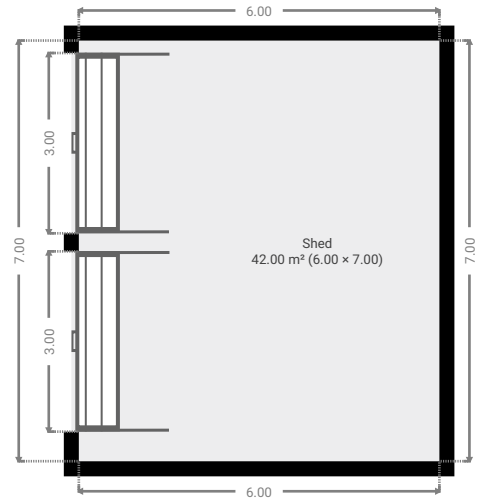

▼ Bedroom Ground Floor

WIDTH: 2.97 m • LENGTH: 3.77 m
AREA: 11.20 m² • PERIMETER: 13.48 m

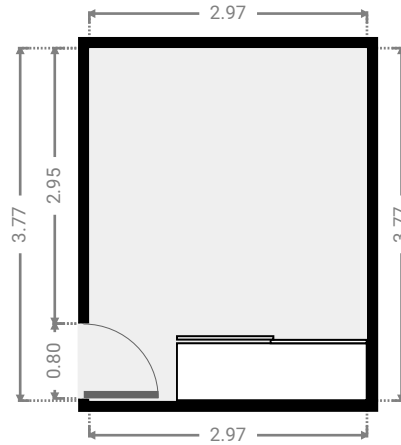
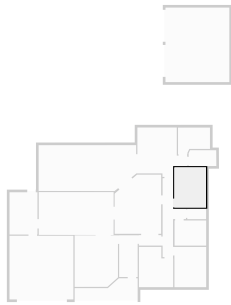

▼ Shed Ground Floor

WIDTH: 6.00 m • LENGTH: 7.00 m
AREA: 42.00 m² • PERIMETER: 26.00 m

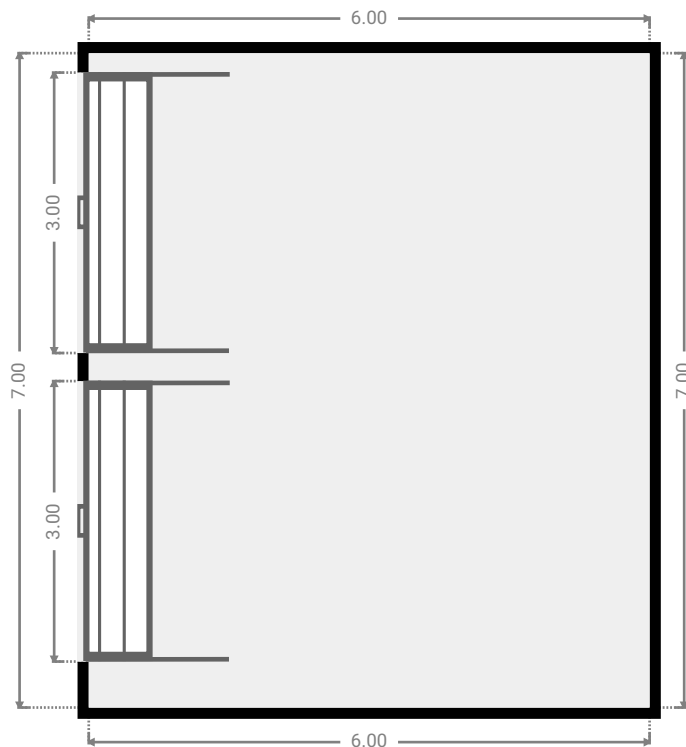
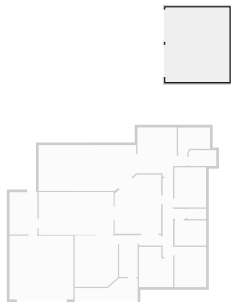

▼ Outdoor Area Ground Floor

WIDTH: 9.16 m • LENGTH: 4.32 m
AREA: 37.80 m² • PERIMETER: 25.88 m

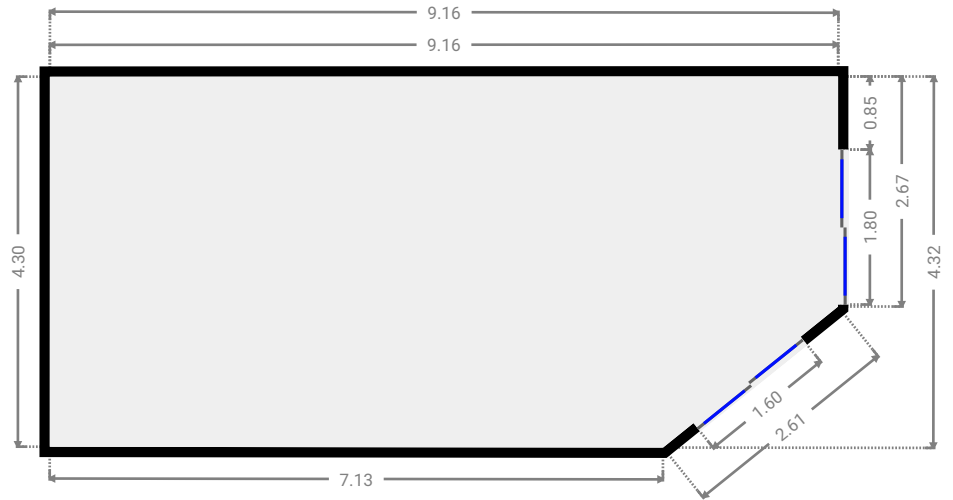
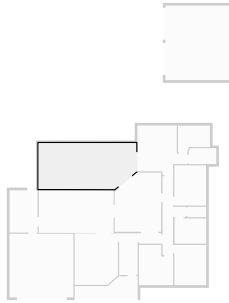

▼ Other Ground Floor

WIDTH: 5.92 m • LENGTH: 1.97 m
AREA: 8.30 m² • PERIMETER: 15.21 m

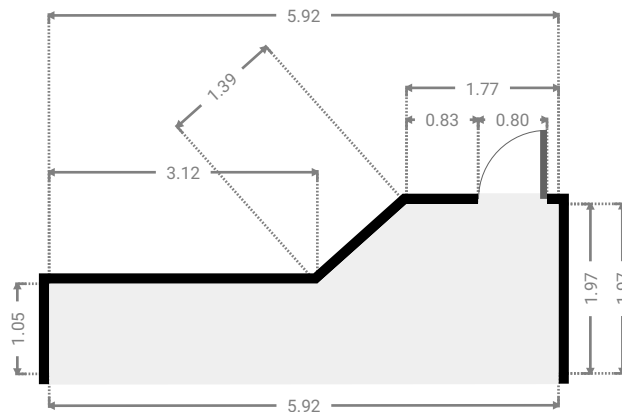

▼ Garage Ground Floor

WIDTH: 6.00 m • LENGTH: 5.98 m
AREA: 35.88 m² • PERIMETER: 23.96 m

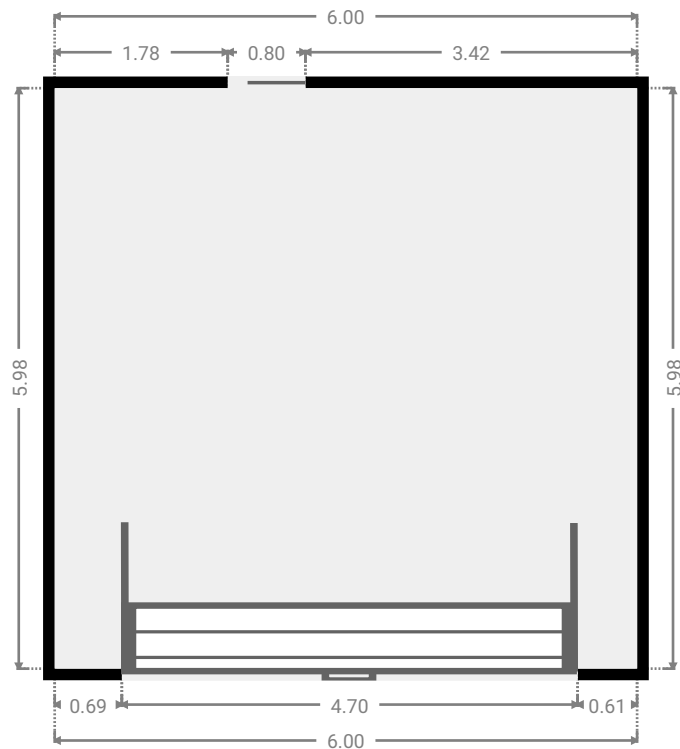
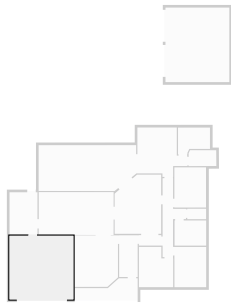

▼ Laundry Room Ground Floor

WIDTH: 2.62 m • LENGTH: 3.97 m
AREA: 10.41 m² • PERIMETER: 13.19 m

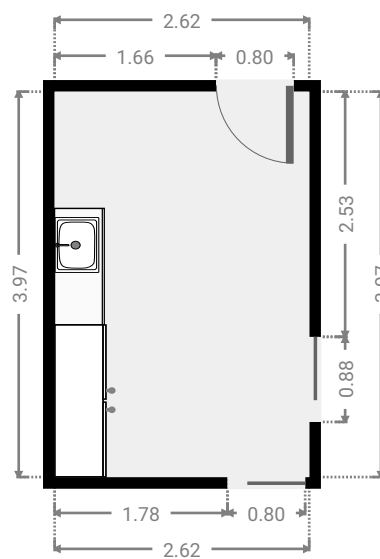
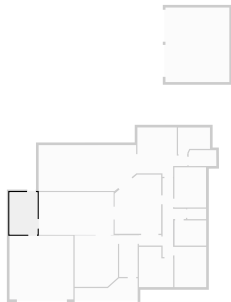

▼ **Kitchen**
Ground Floor

WIDTH: 7.03 m • LENGTH: 4.03 m
AREA: 28.29 m² • PERIMETER: 22.11 m

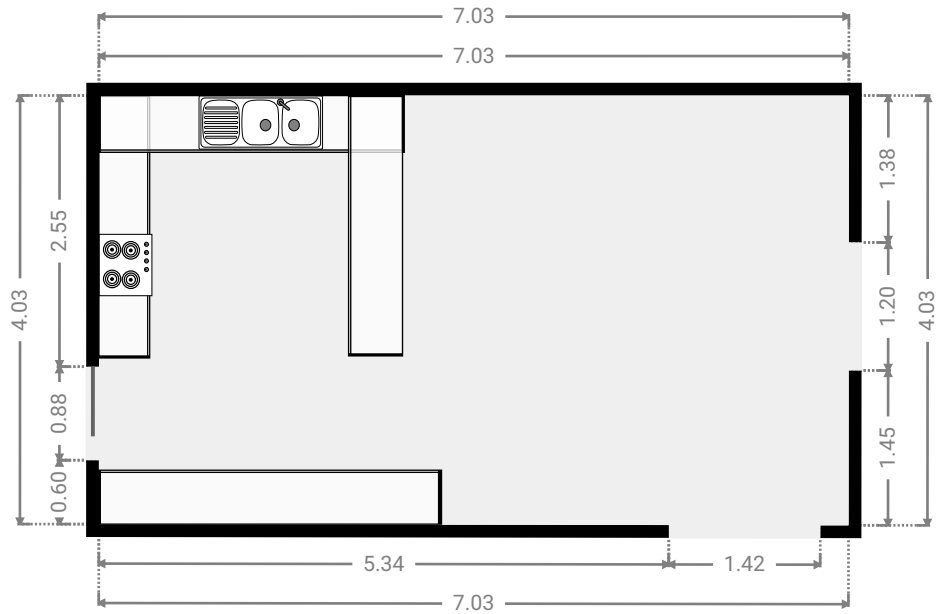
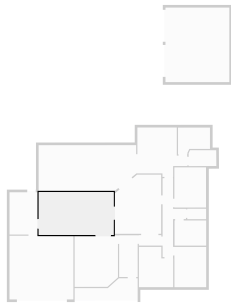

▼ **Bathroom**
Ground Floor

WIDTH: 3.00 m • LENGTH: 2.51 m
AREA: 6.49 m² • PERIMETER: 10.89 m

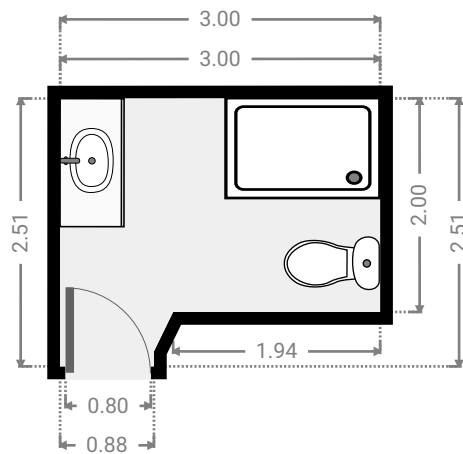
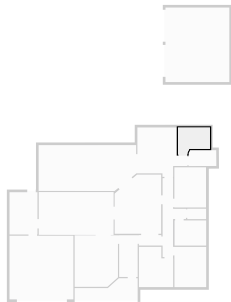

▼ Closet
Ground Floor

WIDTH: 2.60 m • LENGTH: 1.50 m
AREA: 3.84 m² • PERIMETER: 8.06 m

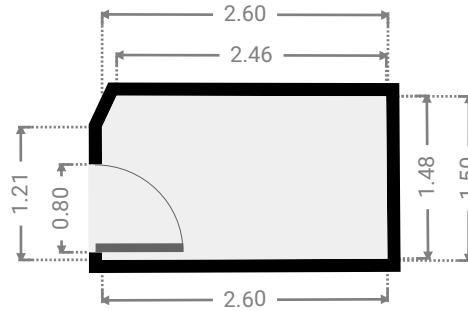
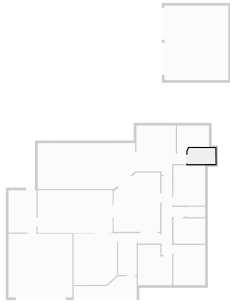

▼ Master Bedroom
Ground Floor

WIDTH: 4.69 m • LENGTH: 4.64 m
AREA: 17.01 m² • PERIMETER: 18.66 m

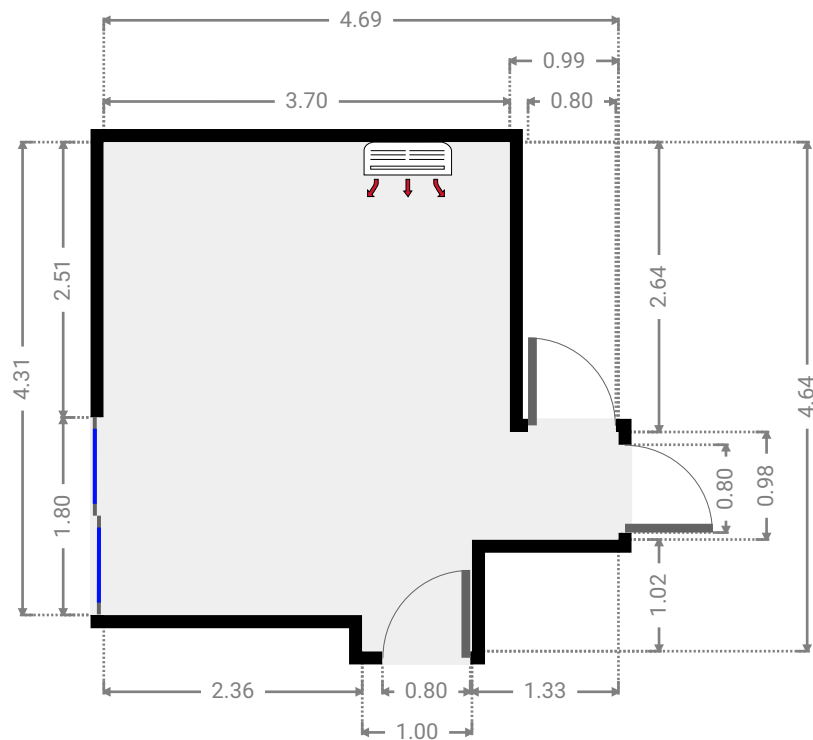
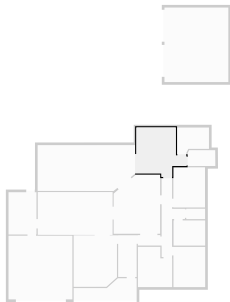

▼ **Hall**
Ground Floor

WIDTH: 1.74 m • LENGTH: 3.92 m
AREA: 6.82 m² • PERIMETER: 11.32 m

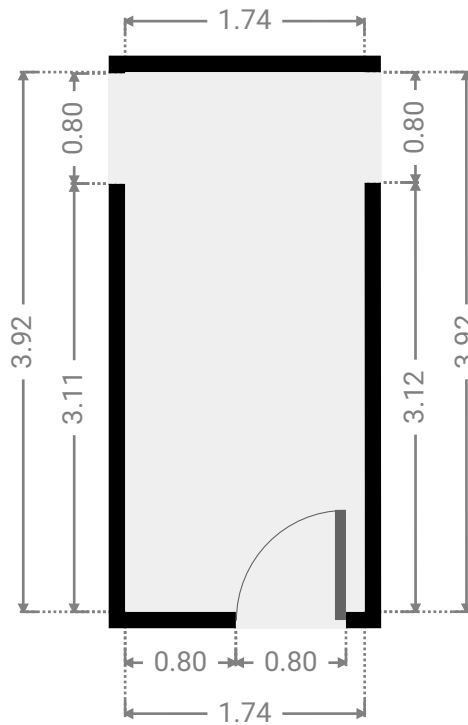
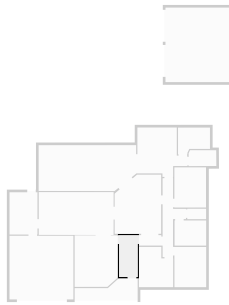

▼ **Toilet**
Ground Floor

WIDTH: 1.77 m • LENGTH: 0.98 m
AREA: 1.73 m² • PERIMETER: 5.49 m

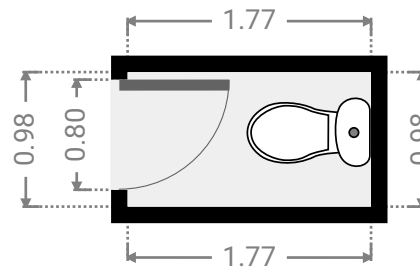
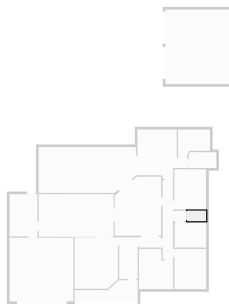

▼ Hall Ground Floor

WIDTH: 1.08 m • LENGTH: 0.96 m
AREA: 1.04 m² • PERIMETER: 4.08 m

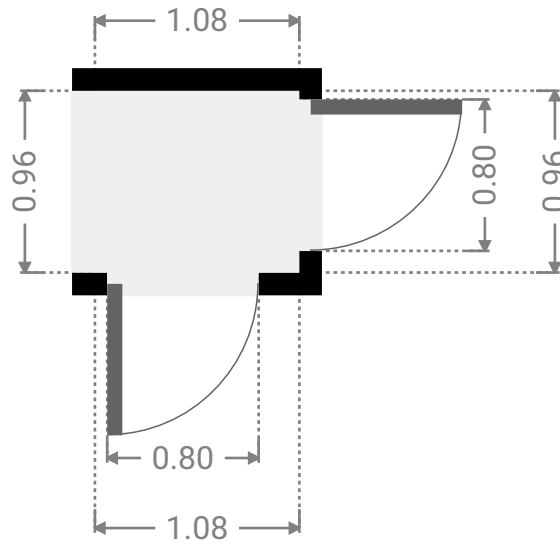
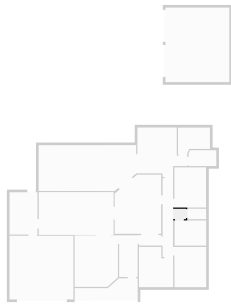

▼ Bathroom Ground Floor

WIDTH: 2.97 m • LENGTH: 2.36 m
AREA: 7.01 m² • PERIMETER: 10.66 m

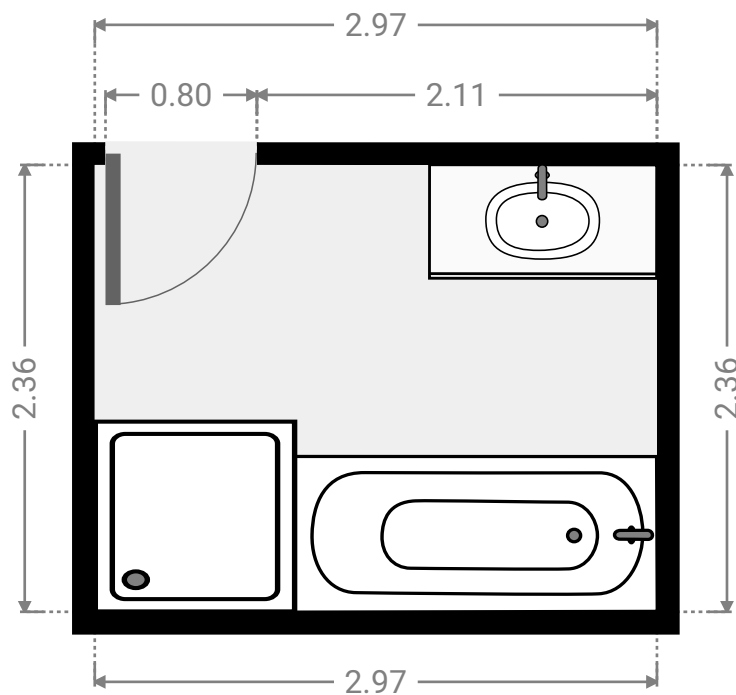
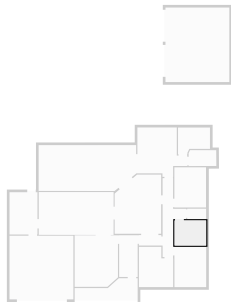

▼ **Bedroom**
Ground Floor

WIDTH: 2.98 m • LENGTH: 3.78 m
AREA: 11.27 m² • PERIMETER: 13.52 m

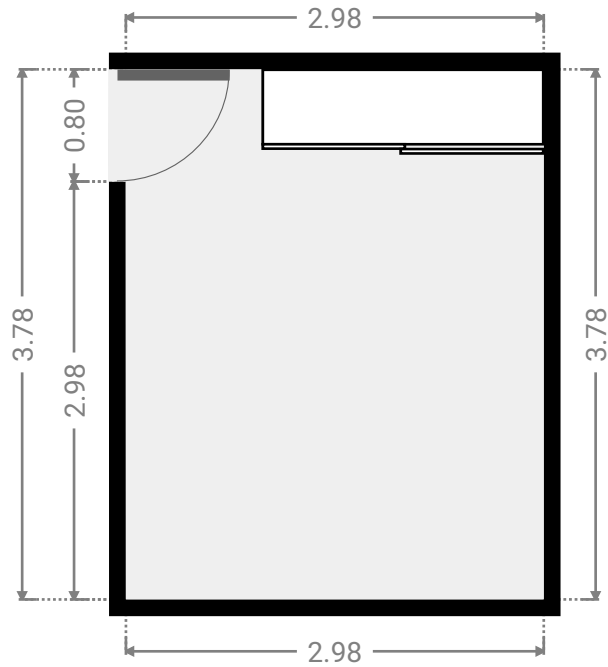
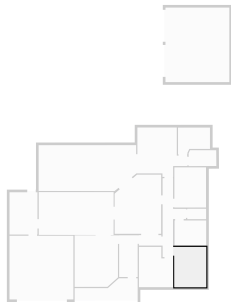

▼ **Bedroom**
Ground Floor

WIDTH: 3.22 m • LENGTH: 3.78 m
AREA: 10.96 m² • PERIMETER: 13.99 m

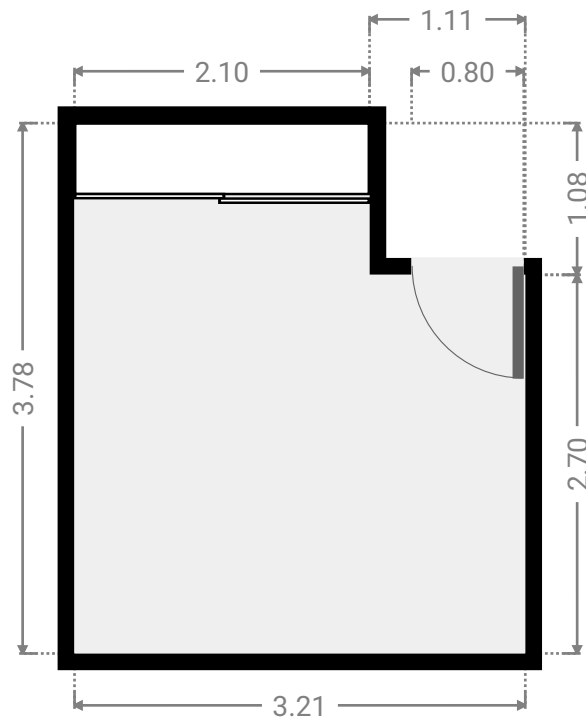
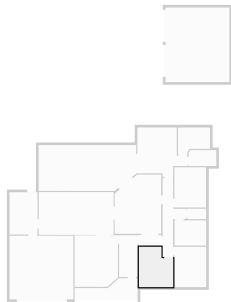

▼ **Hall**
Ground Floor

WIDTH: 0.99 m • LENGTH: 7.42 m
AREA: 7.29 m² • PERIMETER: 16.81 m

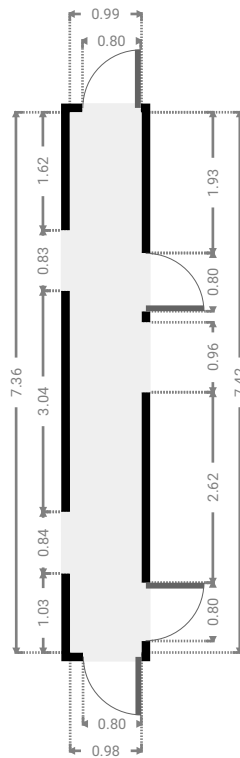
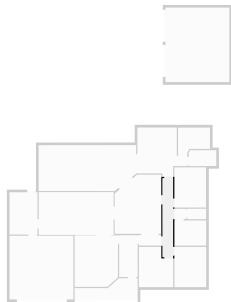

▼ **Living Room**
Ground Floor

WIDTH: 4.37 m • LENGTH: 5.55 m
AREA: 22.40 m² • PERIMETER: 18.72 m

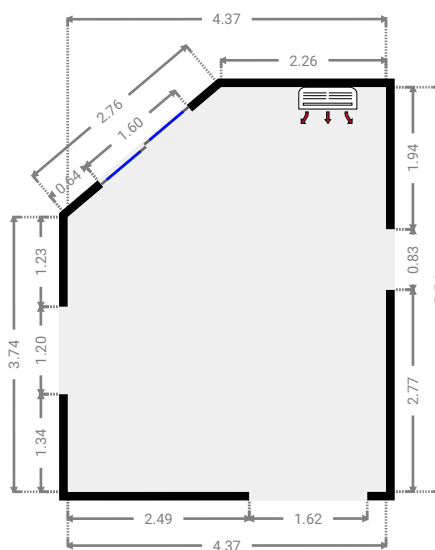
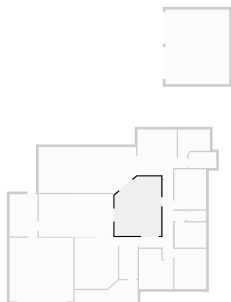

▼ **Hall**
Ground Floor

WIDTH: 2.11 m • LENGTH: 0.98 m
AREA: 2.07 m² • PERIMETER: 6.18 m

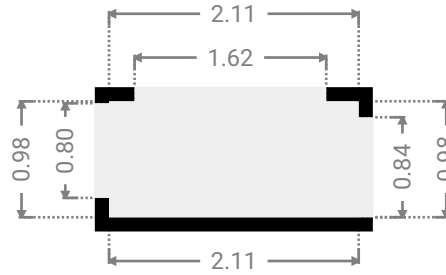
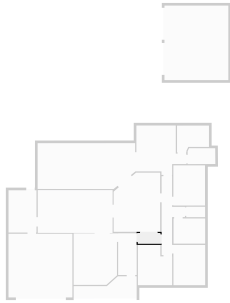

▼ **Living Room**
Ground Floor

WIDTH: 4.07 m • LENGTH: 4.84 m
AREA: 19.25 m² • PERIMETER: 17.27 m

