

23 Goodson Street

Basement

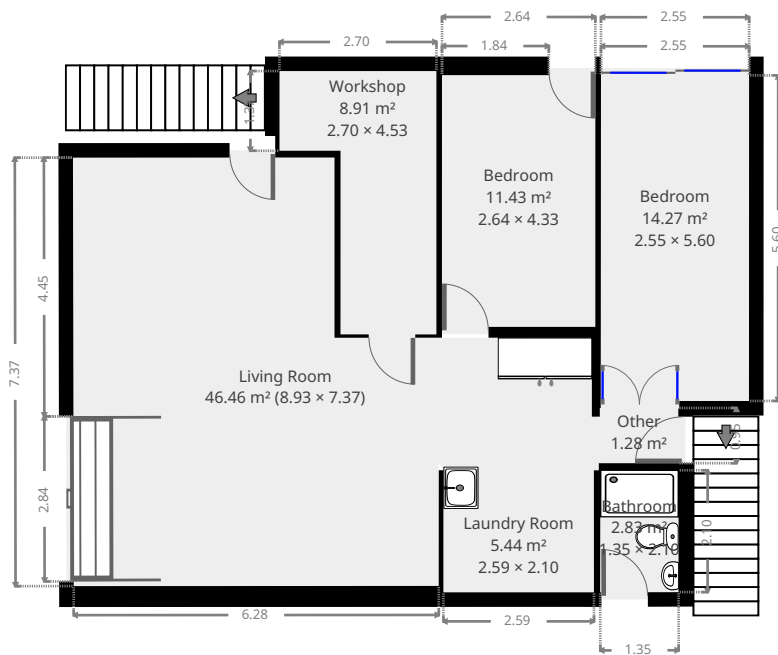

THIS FLOORPLAN IS PROVIDED WITHOUT WARRANTY OF ANY KIND. SENSOPIA DISCLAIMS ANY WARRANTY INCLUDING, WITHOUT LIMITATION, SATISFACTORY QUALITY OR ACCURACY OF DIMENSIONS.



23 Goodson Street

Living Room

Width: 7.37 m
 Length: 8.93 m
 Area: 46.46 m²
 Perimeter: 32.58 m

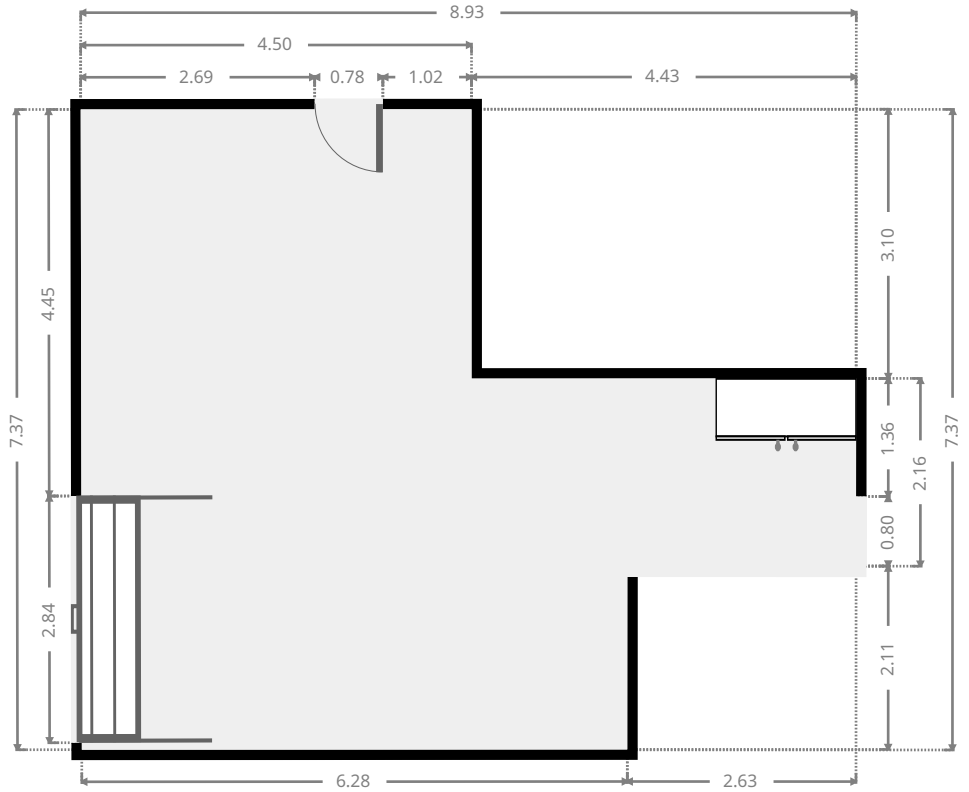
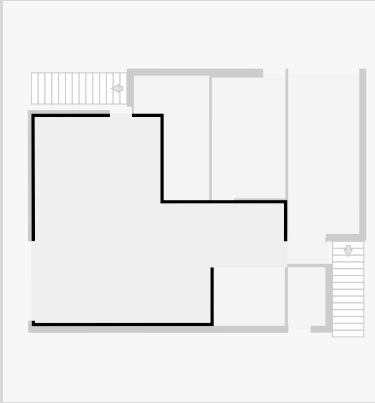

Workshop

Width: 2.70 m
 Length: 4.53 m
 Area: 8.91 m²
 Perimeter: 14.46 m

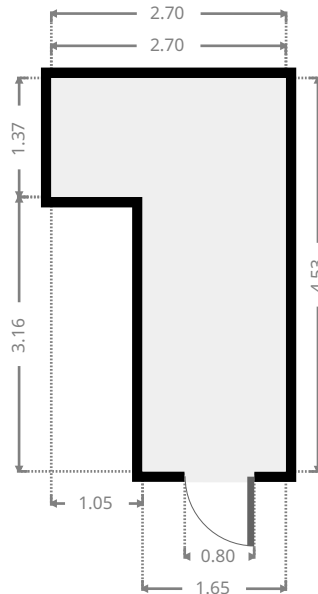
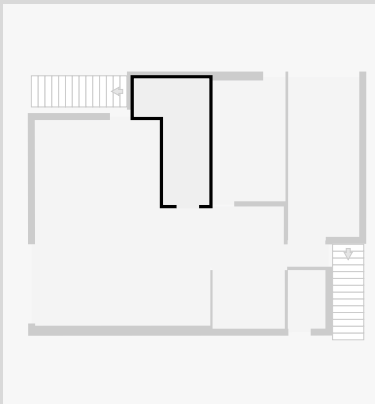

THIS FLOORPLAN IS PROVIDED WITHOUT WARRANTY OF ANY KIND. SENSOPIA DISCLAIMS ANY WARRANTY INCLUDING, WITHOUT LIMITATION, SATISFACTORY QUALITY OR ACCURACY OF DIMENSIONS.



23 Goodson Street

Bedroom

Width: 2.64 m
Length: 4.33 m
Area: 11.43 m²
Perimeter: 13.94 m

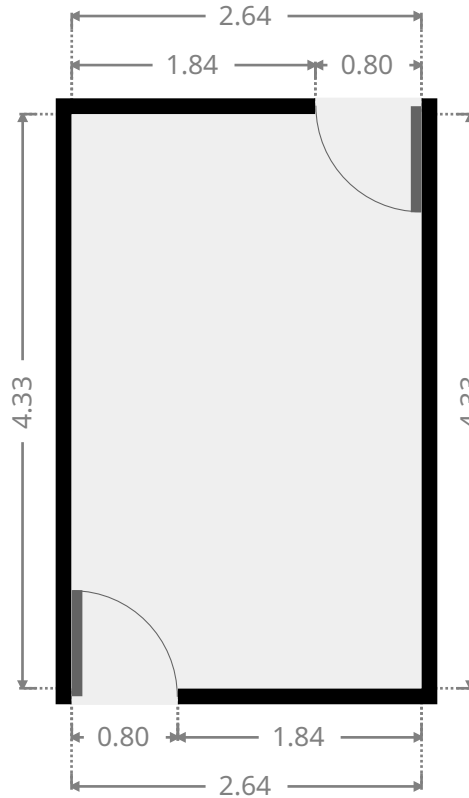

Laundry Room

Width: 2.10 m
Length: 2.59 m
Area: 5.44 m²
Perimeter: 9.38 m

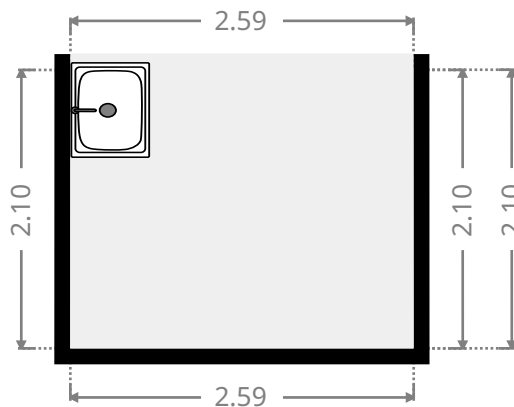
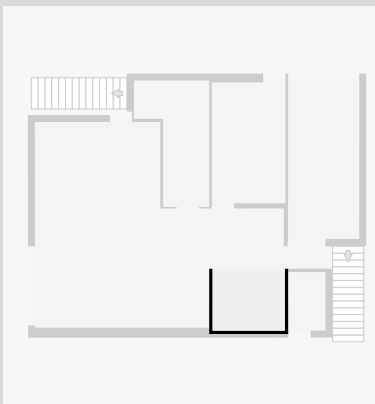

23 Goodson Street

Other

Width: 0.95 m
 Length: 1.35 m
 Area: 1.28 m²
 Perimeter: 4.60 m

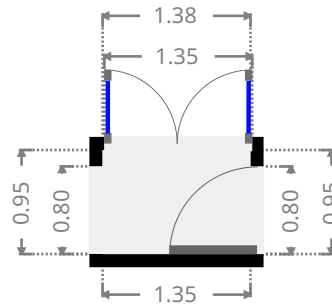
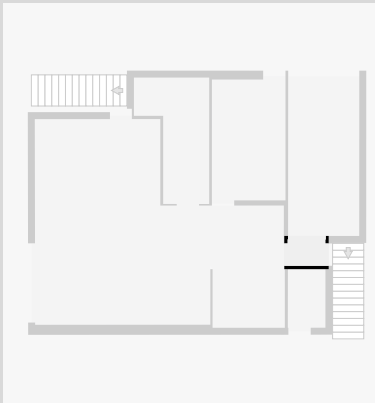

Bedroom

Width: 2.55 m
 Length: 5.60 m
 Area: 14.27 m²
 Perimeter: 16.30 m

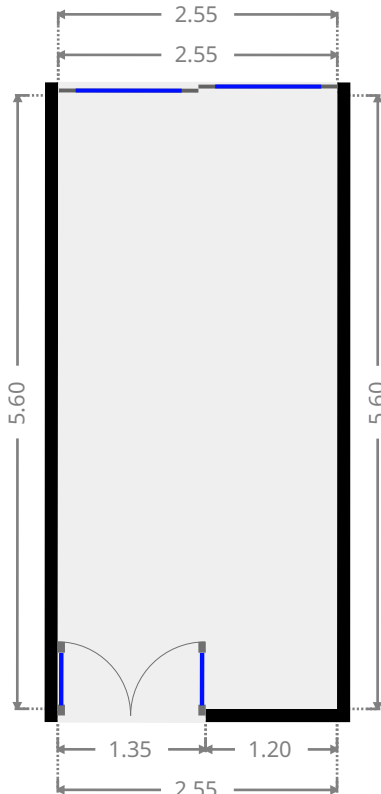
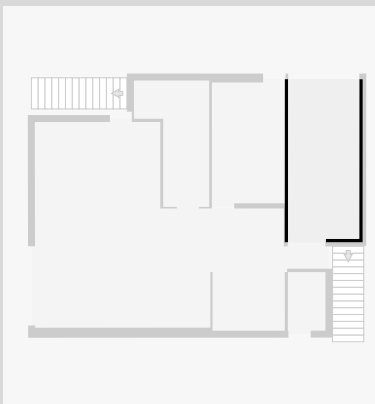

THIS FLOORPLAN IS PROVIDED WITHOUT WARRANTY OF ANY KIND. SENSOPIA DISCLAIMS ANY WARRANTY INCLUDING, WITHOUT LIMITATION, SATISFACTORY QUALITY OR ACCURACY OF DIMENSIONS.



23 Goodson Street

Bathroom

Width: 1.35 m
Length: 2.10 m
Area: 2.83 m²
Perimeter: 6.89 m

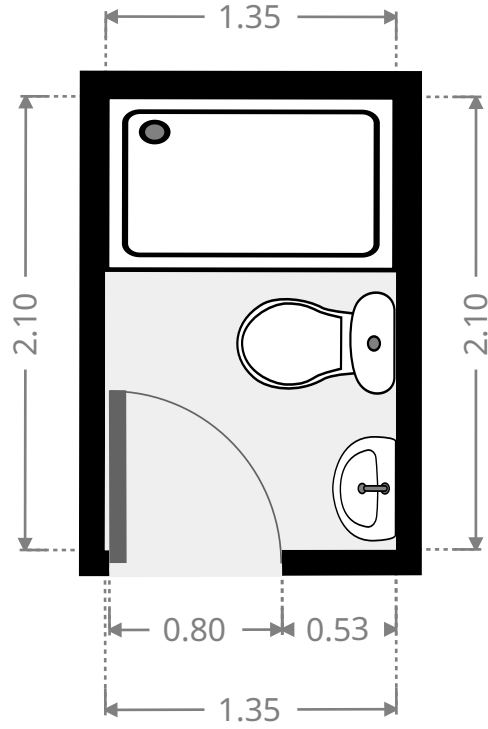
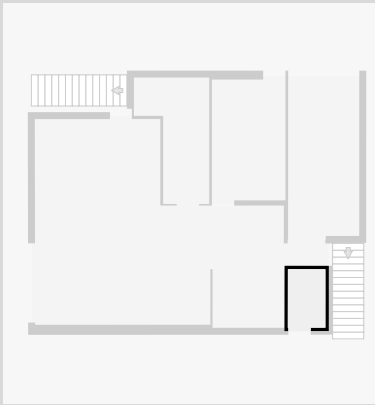

23 Goodson Street

Ground Floor

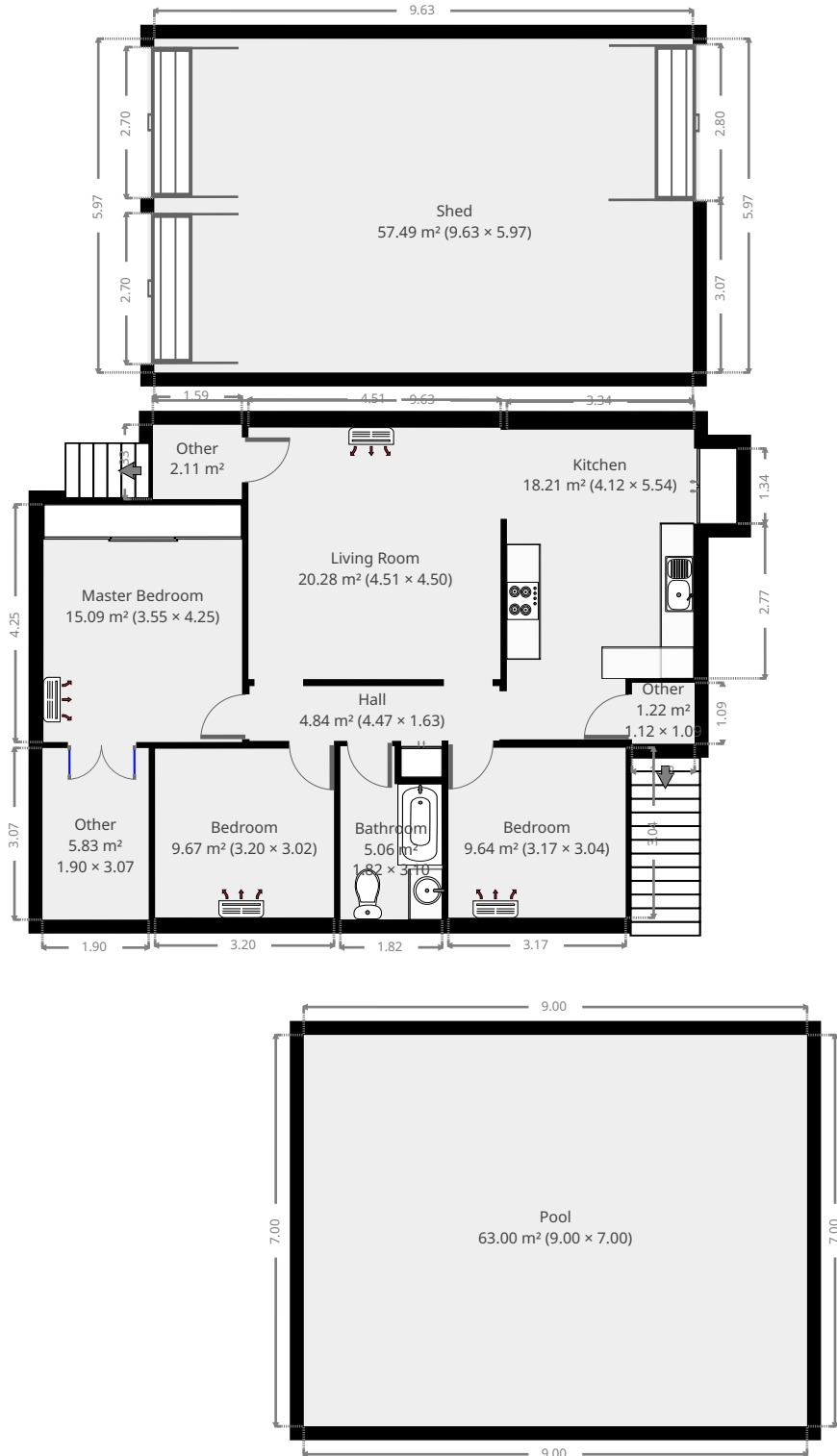

THIS FLOORPLAN IS PROVIDED WITHOUT WARRANTY OF ANY KIND. SENSOPIA DISCLAIMS ANY WARRANTY INCLUDING, WITHOUT LIMITATION, SATISFACTORY QUALITY OR ACCURACY OF DIMENSIONS.



23 Goodson Street

Living Room

Width: 4.50 m
 Length: 4.51 m
 Area: 20.28 m²
 Perimeter: 18.01 m

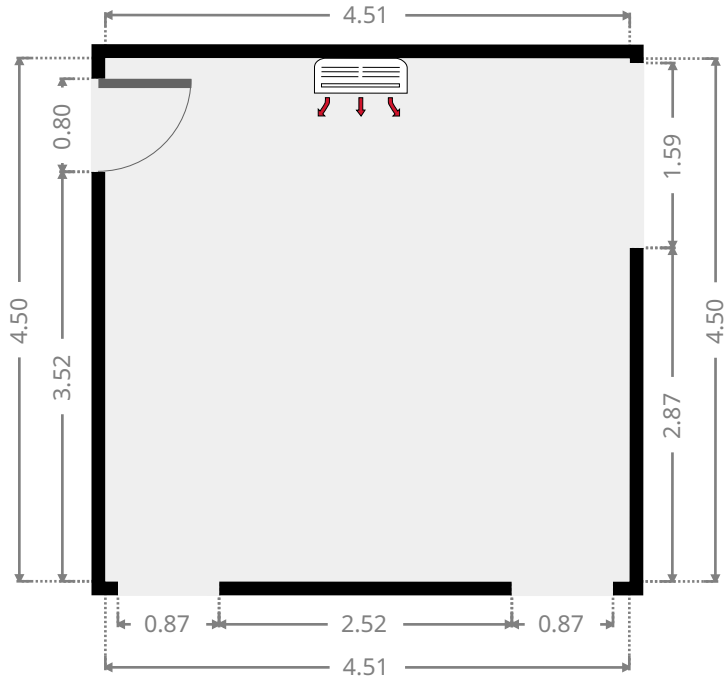
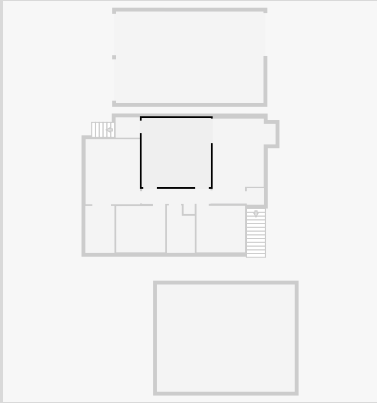

Kitchen

Width: 4.12 m
 Length: 5.54 m
 Area: 18.21 m²
 Perimeter: 19.31 m

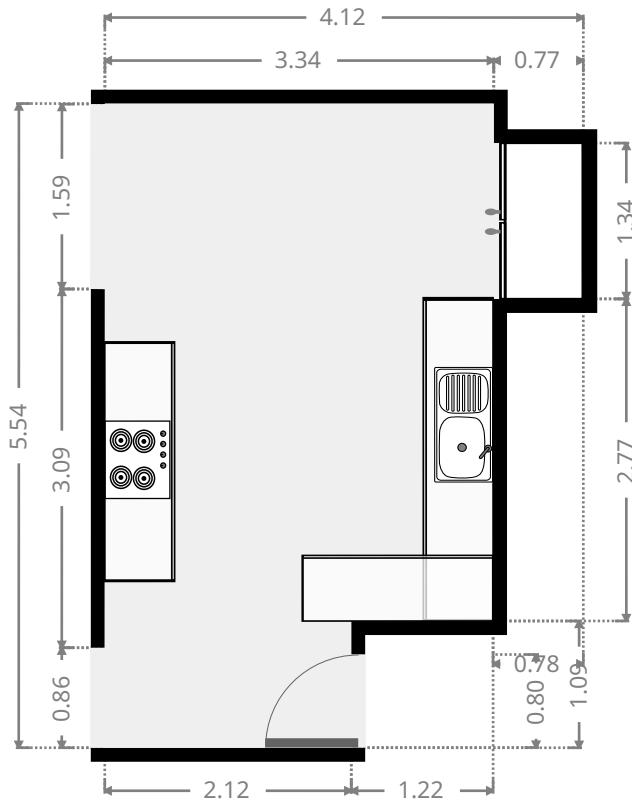
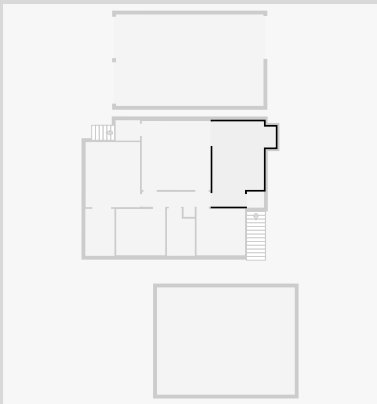

THIS FLOORPLAN IS PROVIDED WITHOUT WARRANTY OF ANY KIND. SENSOPIA DISCLAIMS ANY WARRANTY INCLUDING, WITHOUT LIMITATION, SATISFACTORY QUALITY OR ACCURACY OF DIMENSIONS.

23 Goodson Street

Hall

Width: 1.63 m
 Length: 4.47 m
 Area: 4.84 m²
 Perimeter: 12.21 m

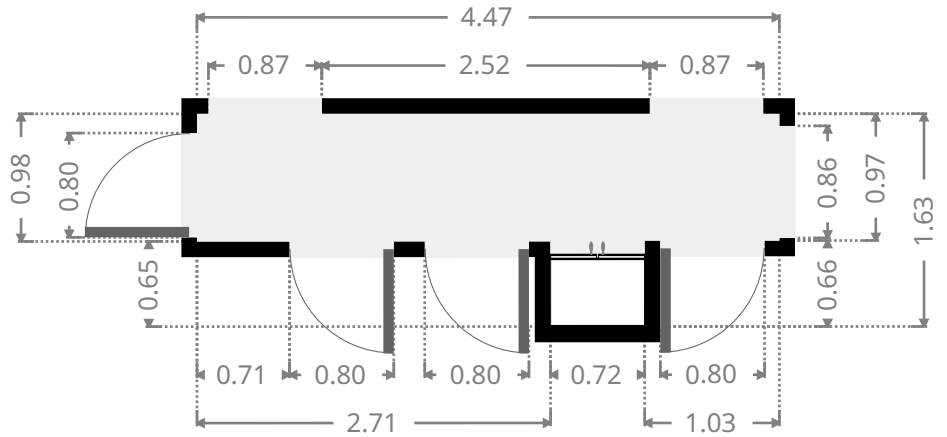
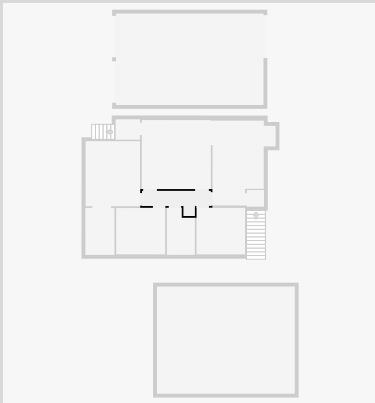

Bedroom

Width: 3.04 m
 Length: 3.17 m
 Area: 9.64 m²
 Perimeter: 12.42 m

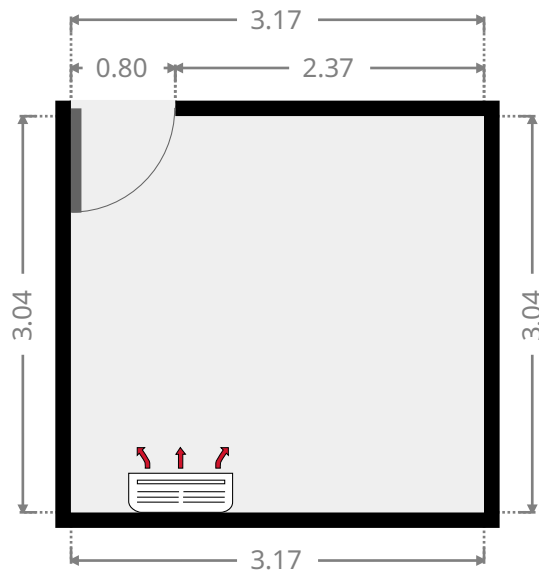
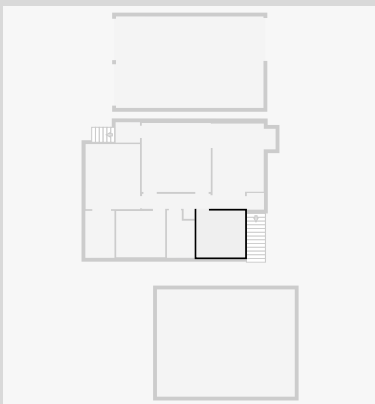

THIS FLOORPLAN IS PROVIDED WITHOUT WARRANTY OF ANY KIND. SENSOPIA DISCLAIMS ANY WARRANTY INCLUDING, WITHOUT LIMITATION, SATISFACTORY QUALITY OR ACCURACY OF DIMENSIONS.

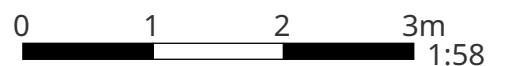

23 Goodson Street

Bathroom

Width: 1.82 m
Length: 3.10 m
Area: 5.06 m²
Perimeter: 9.84 m

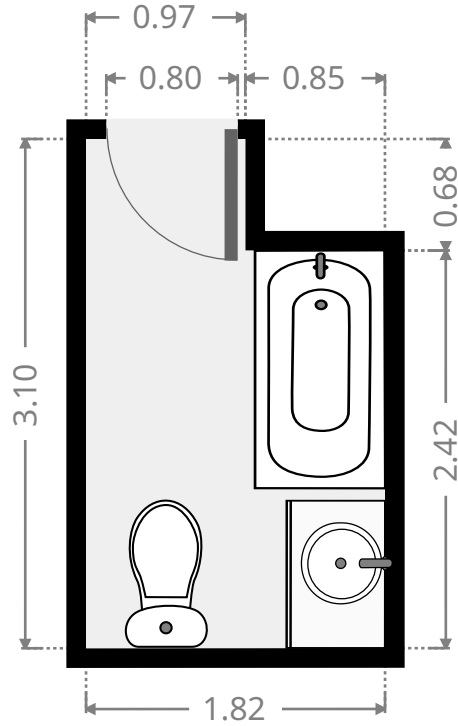
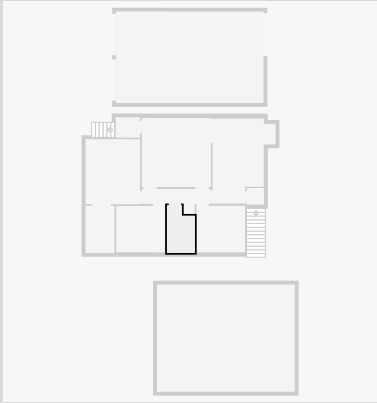

Bedroom

Width: 3.02 m
Length: 3.20 m
Area: 9.67 m²
Perimeter: 12.44 m

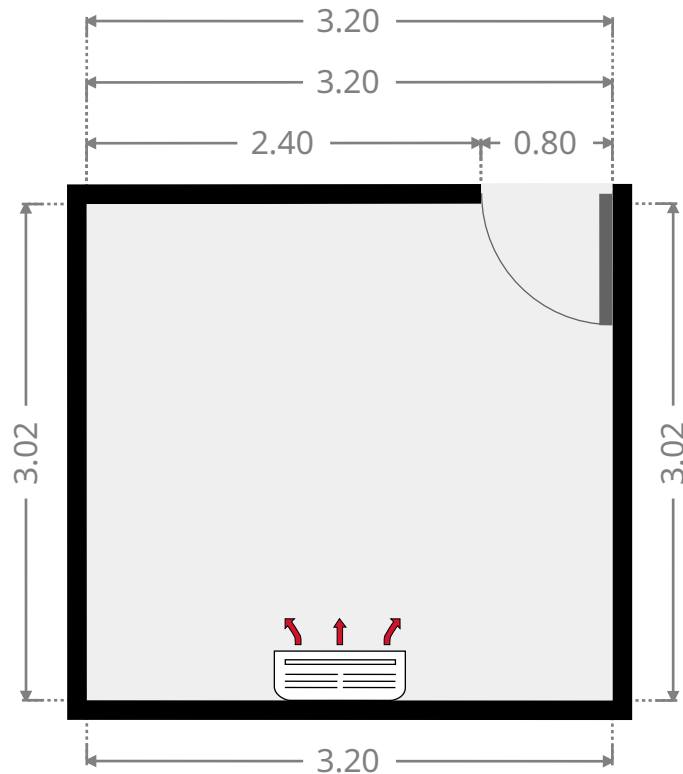
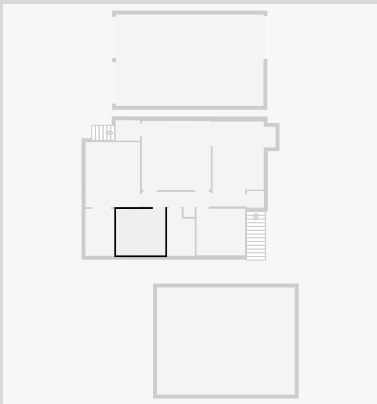

THIS FLOORPLAN IS PROVIDED WITHOUT WARRANTY OF ANY KIND. SENSOPIA DISCLAIMS ANY WARRANTY INCLUDING, WITHOUT LIMITATION, SATISFACTORY QUALITY OR ACCURACY OF DIMENSIONS.

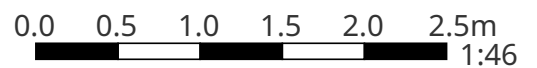

23 Goodson Street

Master Bedroom

Width: 3.55 m
 Length: 4.25 m
 Area: 15.09 m²
 Perimeter: 15.60 m

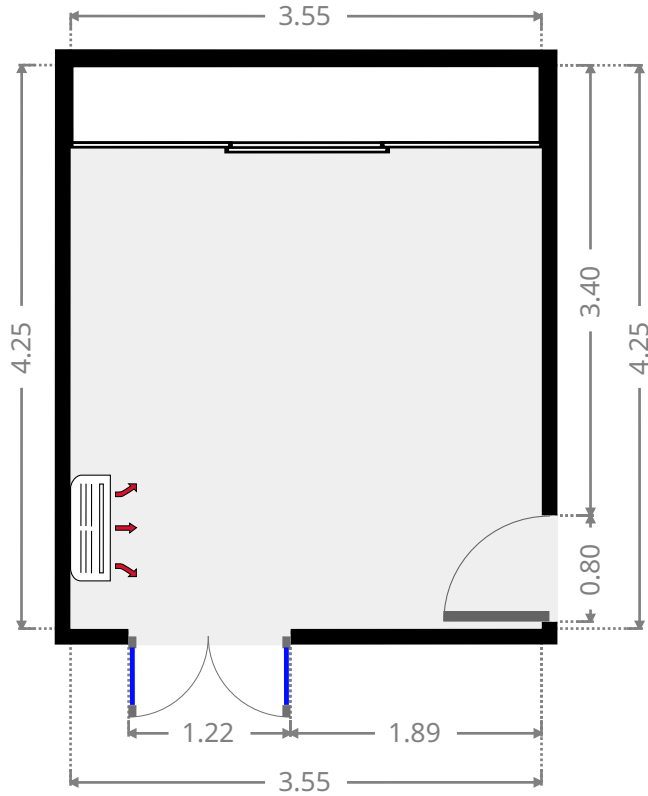
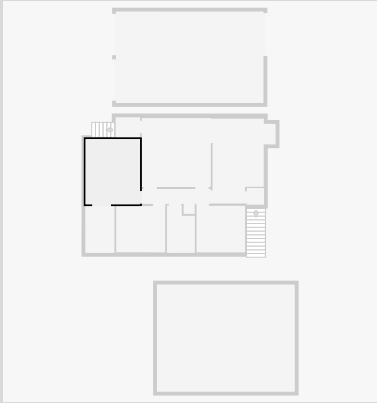

Other

Width: 1.90 m
 Length: 3.07 m
 Area: 5.83 m²
 Perimeter: 9.94 m

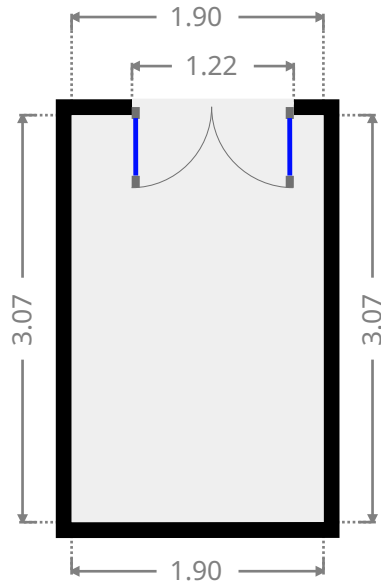
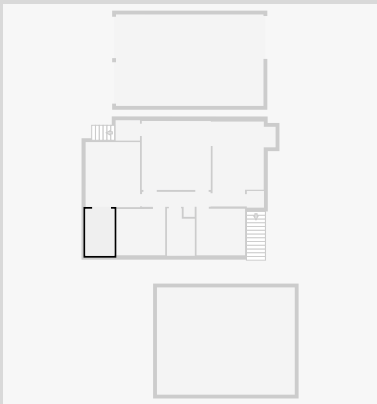

THIS FLOORPLAN IS PROVIDED WITHOUT WARRANTY OF ANY KIND. SENSOPIA DISCLAIMS ANY WARRANTY INCLUDING, WITHOUT LIMITATION, SATISFACTORY QUALITY OR ACCURACY OF DIMENSIONS.

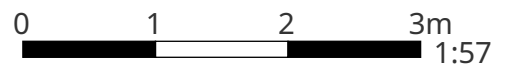

23 Goodson Street

Other

Width: 1.33 m
Length: 1.59 m
Area: 2.11 m²
Perimeter: 5.84 m

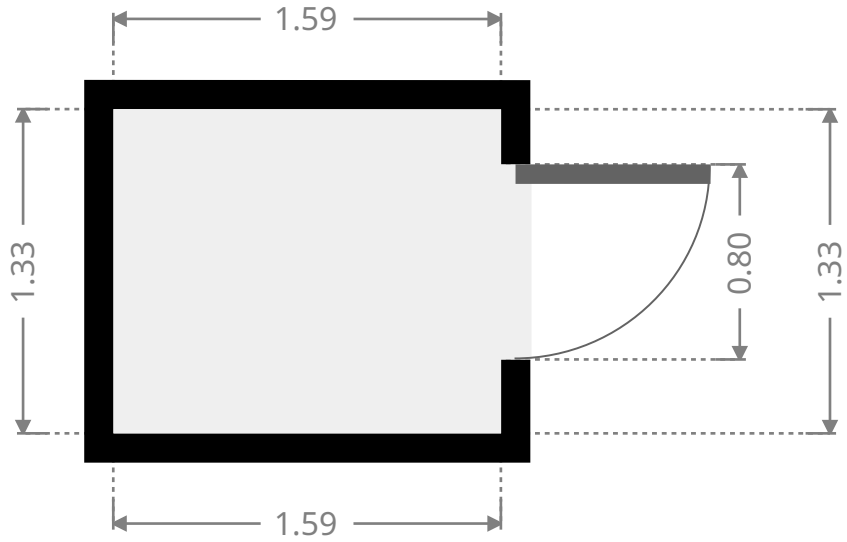
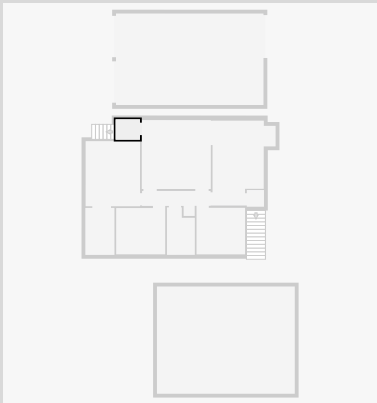

Other

Width: 1.09 m
Length: 1.12 m
Area: 1.22 m²
Perimeter: 4.42 m

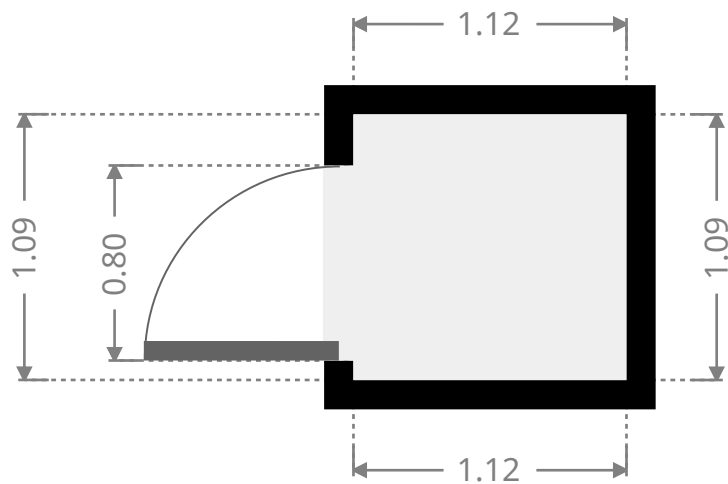
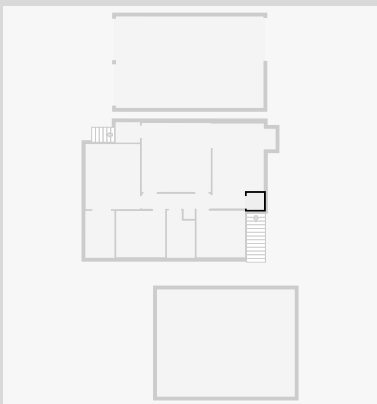

23 Goodson Street

Shed

Width: 5.97 m
Length: 9.63 m
Area: 57.49 m²
Perimeter: 31.20 m

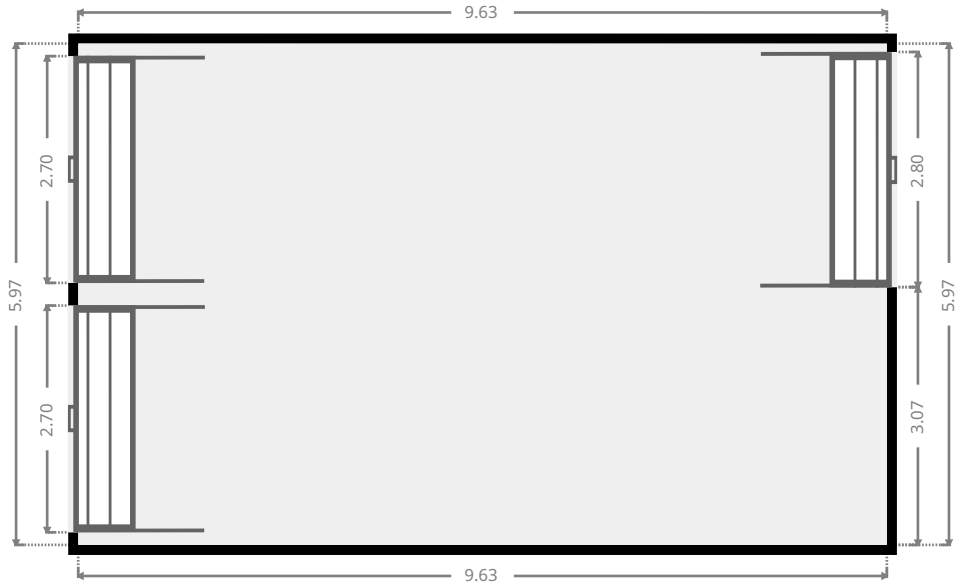
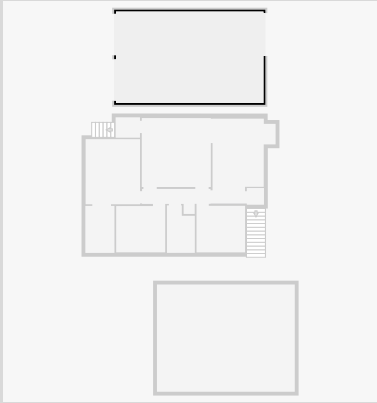

Pool

Width: 7.00 m
Length: 9.00 m
Area: 63.00 m²
Perimeter: 32.00 m

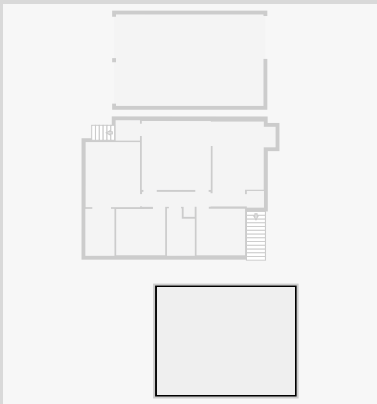

THIS FLOORPLAN IS PROVIDED WITHOUT WARRANTY OF ANY KIND. SENSOPIA DISCLAIMS ANY WARRANTY INCLUDING, WITHOUT LIMITATION, SATISFACTORY QUALITY OR ACCURACY OF DIMENSIONS.

