

224 Richardson Road

Created on
2020-06-30

Floors

2

▼ Ground Floor



THIS FLOORPLAN IS PROVIDED WITHOUT WARRANTY OF ANY KIND. SENSOPIA DISCLAIMS ANY WARRANTY INCLUDING, WITHOUT LIMITATION, SATISFACTORY QUALITY OR ACCURACY OF DIMENSIONS.

0 1 2 3m 1:71

FLOORS: 2

▼ **Garage**
Ground Floor

WIDTH: 11.21 m • **LENGTH:** 7.05 m
AREA: 52.34 m² • **PERIMETER:** 36.51 m

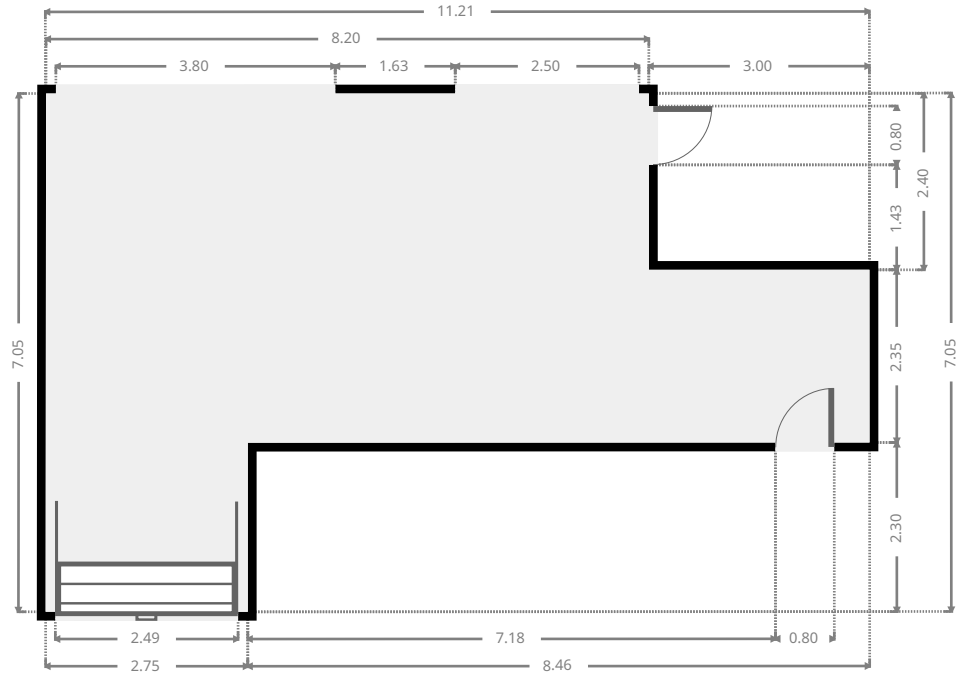
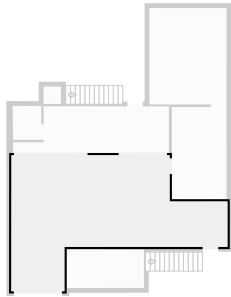

▼ **Laundry Room**
Ground Floor

WIDTH: 8.08 m • **LENGTH:** 2.44 m
AREA: 16.73 m² • **PERIMETER:** 21.03 m

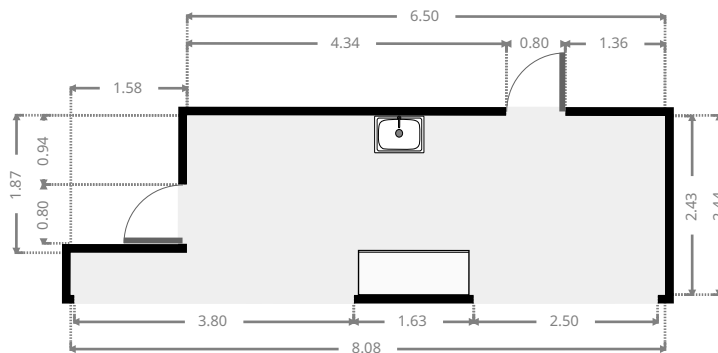
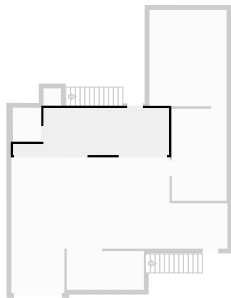

THIS FLOORPLAN IS PROVIDED WITHOUT WARRANTY OF ANY KIND. SENSOPIA DISCLAIMS ANY WARRANTY INCLUDING, WITHOUT LIMITATION, SATISFACTORY QUALITY OR ACCURACY OF DIMENSIONS.



FLOORS: 2

▼ **Toilet**
Ground Floor

WIDTH: 1.49 m • **LENGTH:** 1.76 m
AREA: 2.58 m² • **PERIMETER:** 6.45 m

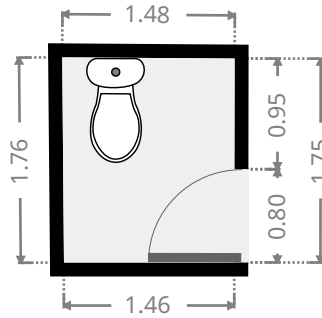
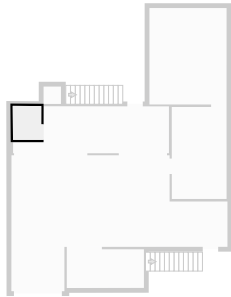

▼ **Living Room**
Ground Floor

WIDTH: 2.84 m • **LENGTH:** 4.77 m
AREA: 13.56 m² • **PERIMETER:** 15.22 m

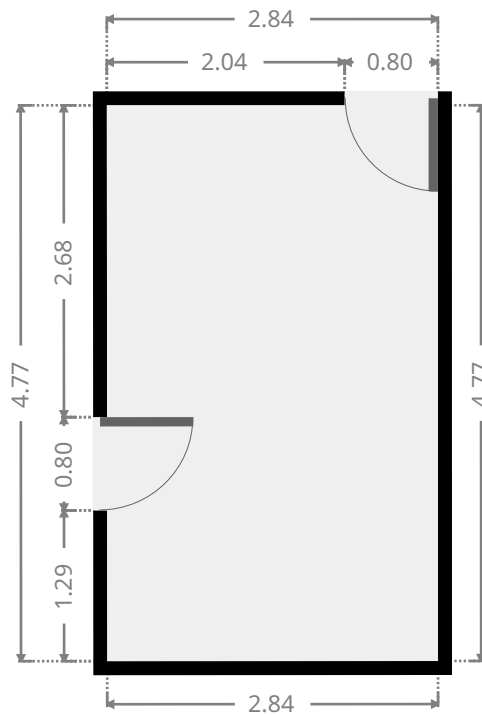
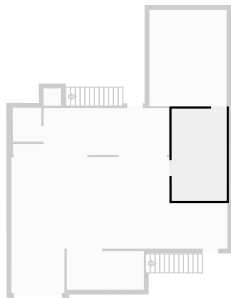

FLOORS: 2

▼ **Outdoor Area**
Ground Floor

WIDTH: 4.00 m • LENGTH: 5.00 m
AREA: 20.00 m² • PERIMETER: 18.00 m

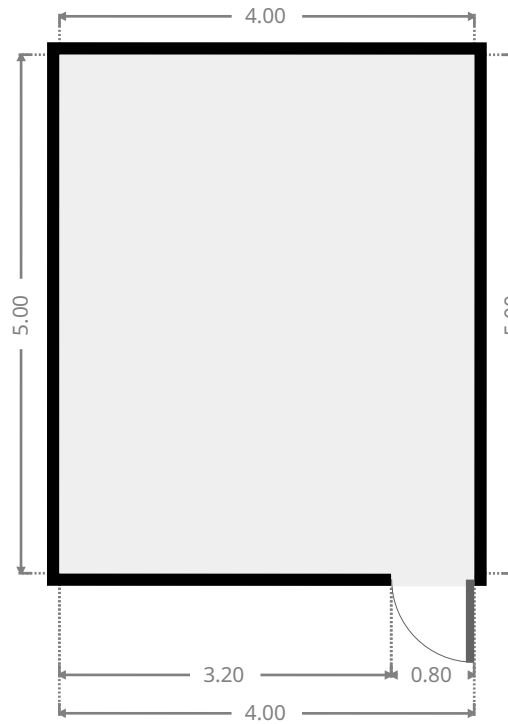
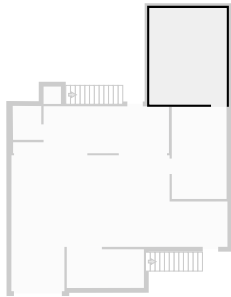

▼ **Other**
Ground Floor

WIDTH: 4.00 m • LENGTH: 2.01 m
AREA: 8.02 m² • PERIMETER: 12.01 m

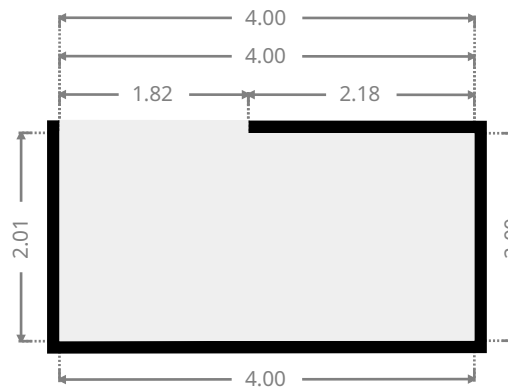
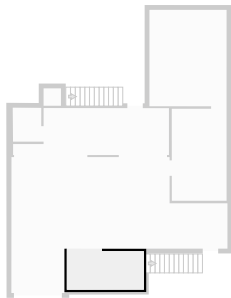

FLOORS: 2

▼ **Other**
Ground Floor

WIDTH: 0.90 m • LENGTH: 0.90 m
AREA: 0.81 m² • PERIMETER: 3.60 m

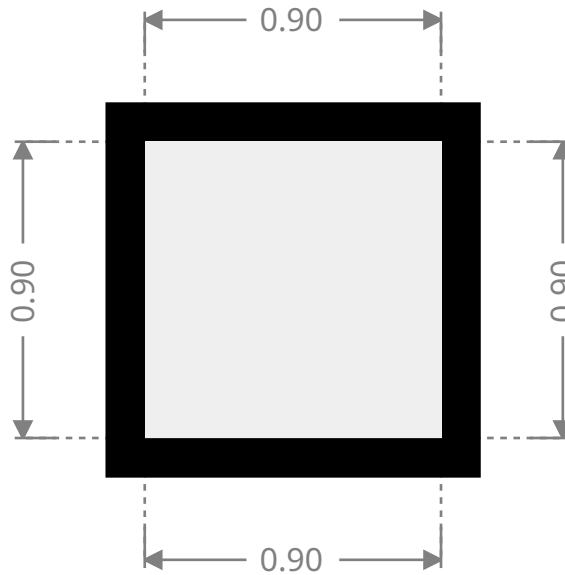
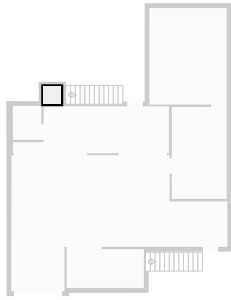

▼ 1st Floor



THIS FLOORPLAN IS PROVIDED WITHOUT WARRANTY OF ANY KIND. SENSOPIA DISCLAIMS ANY WARRANTY INCLUDING, WITHOUT LIMITATION, SATISFACTORY QUALITY OR ACCURACY OF DIMENSIONS.

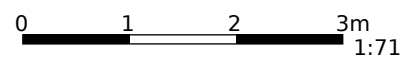

FLOORS: 2

▼ **Living Room**
1st Floor

WIDTH: 6.72 m • LENGTH: 2.06 m
AREA: 13.84 m² • PERIMETER: 17.56 m

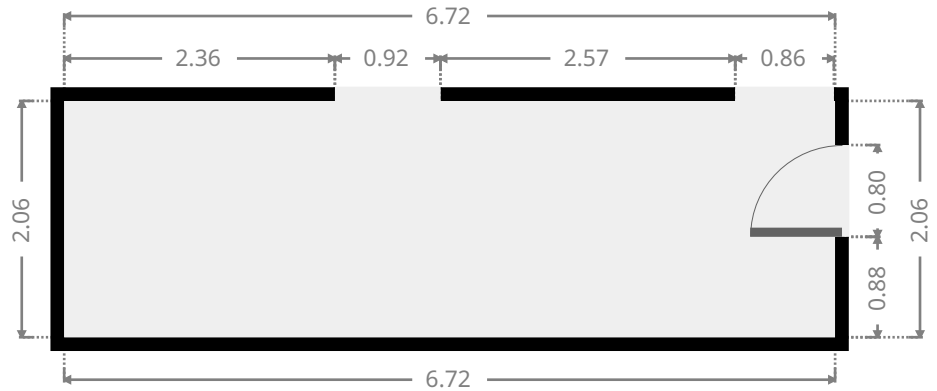
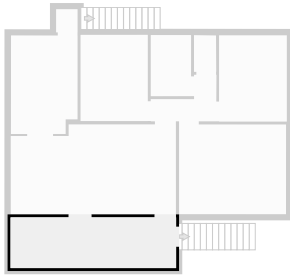

▼ **Living/Dining**
1st Floor

WIDTH: 6.70 m • LENGTH: 3.65 m
AREA: 23.36 m² • PERIMETER: 20.71 m

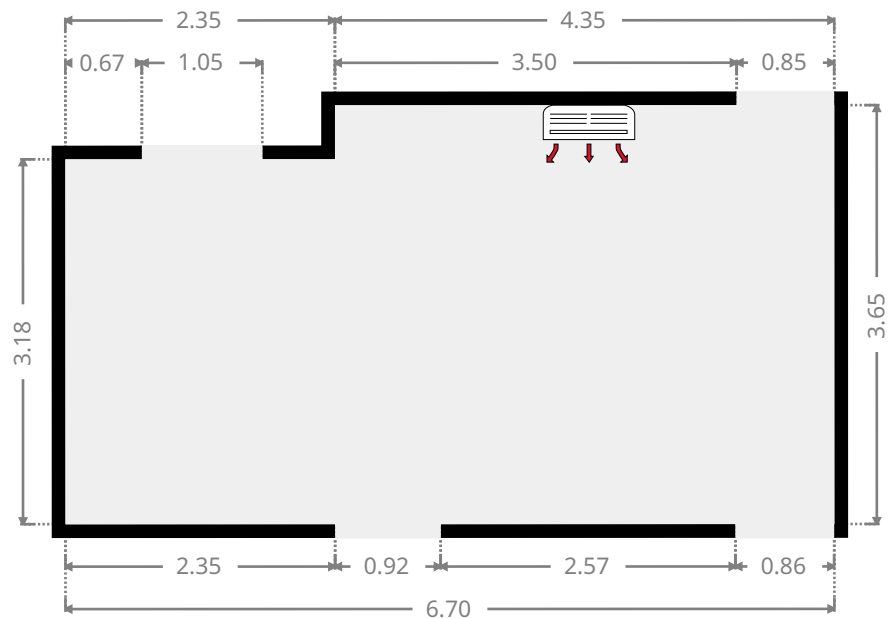
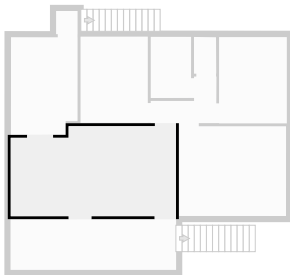

FLOORS: 2

▼ **Kitchen**
1st Floor

WIDTH: 2.70 m • **LENGTH:** 4.00 m
AREA: 10.51 m² • **PERIMETER:** 13.39 m

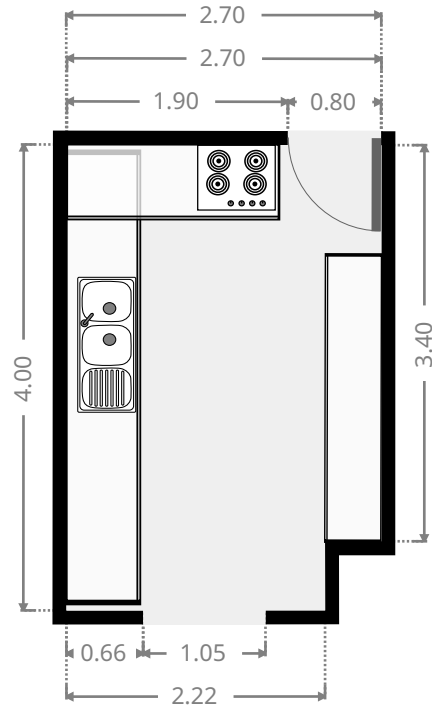
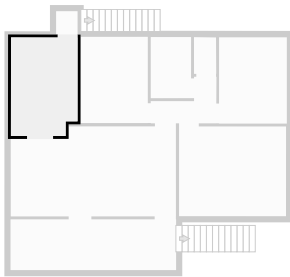

▼ **Other**
1st Floor

WIDTH: 0.87 m • **LENGTH:** 0.94 m
AREA: 0.82 m² • **PERIMETER:** 3.62 m

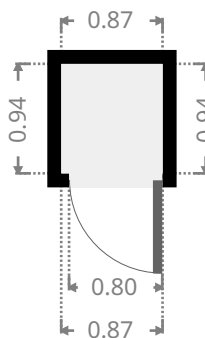
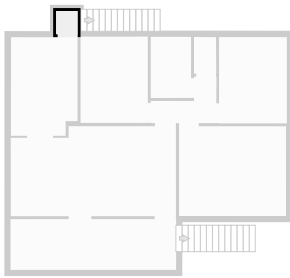

FLOORS: 2

▼ **Hall**
1st Floor

WIDTH: 2.67 m • **LENGTH:** 1.89 m
AREA: 3.29 m² • **PERIMETER:** 9.10 m

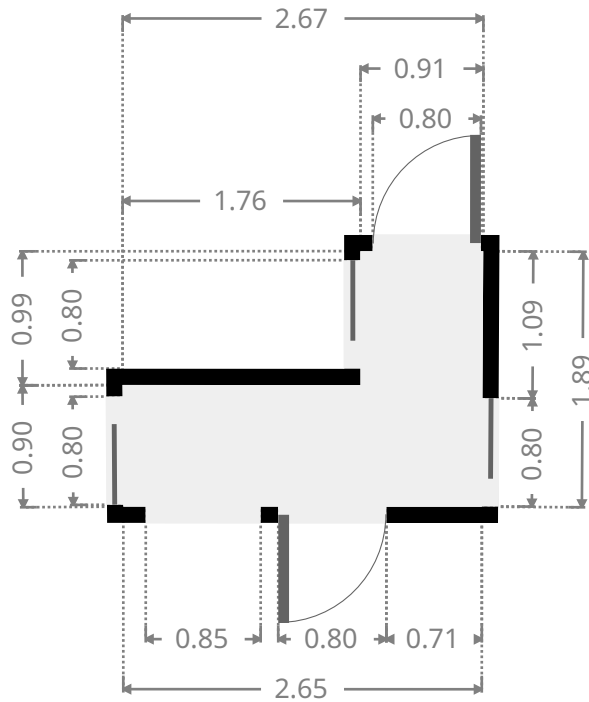
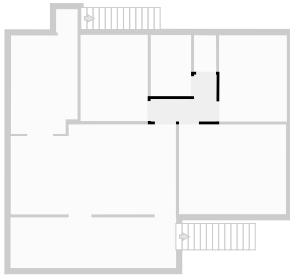

▼ **Bedroom**
1st Floor

WIDTH: 2.73 m • **LENGTH:** 3.50 m
AREA: 9.55 m² • **PERIMETER:** 12.46 m

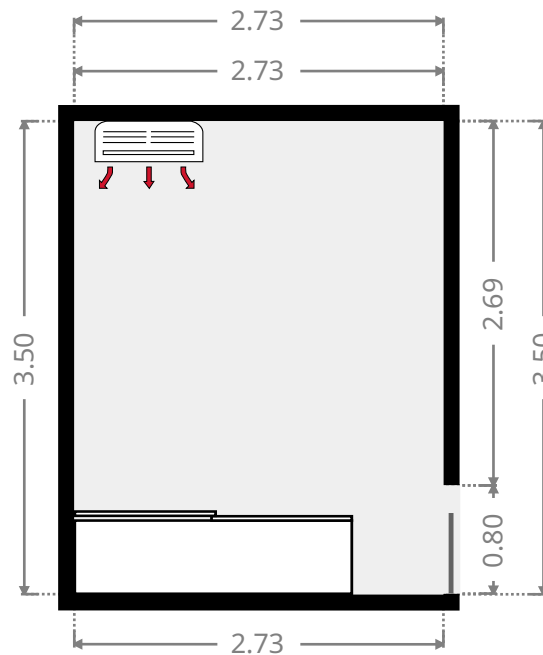
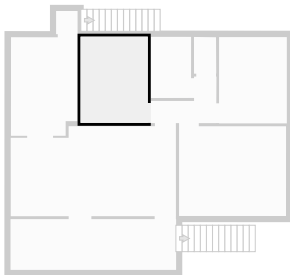

FLOORS: 2

▼ **Bathroom**
1st Floor

WIDTH: 1.64 m • **LENGTH:** 2.48 m
AREA: 4.06 m² • **PERIMETER:** 8.23 m

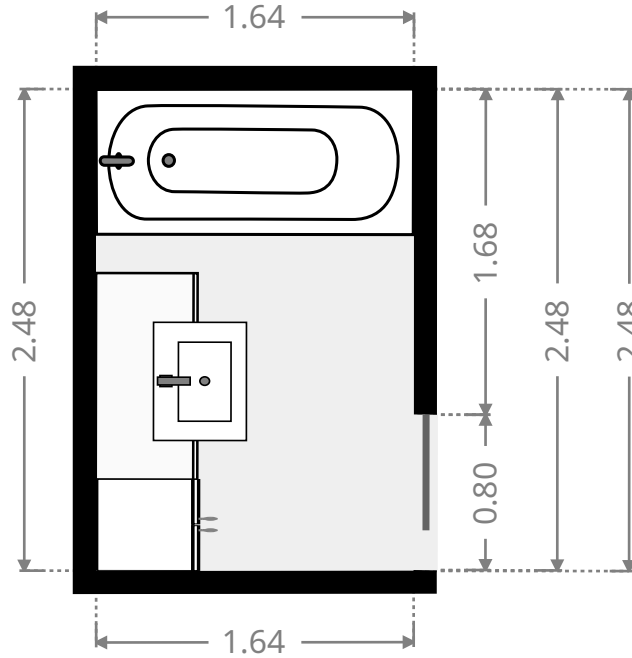
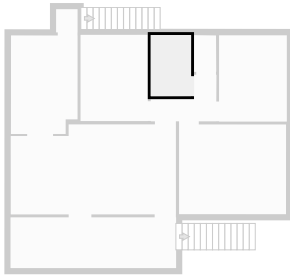

▼ **Toilet**
1st Floor

WIDTH: 0.90 m • **LENGTH:** 1.49 m
AREA: 1.33 m² • **PERIMETER:** 4.76 m

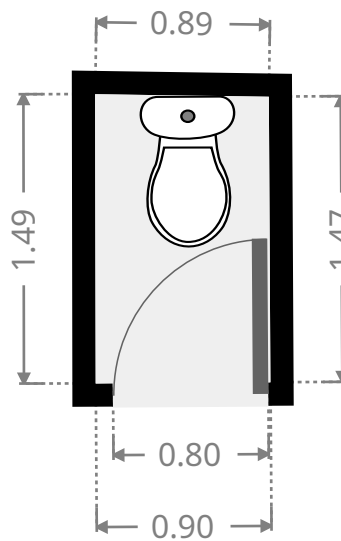
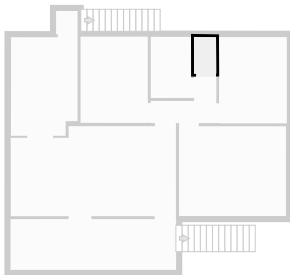

FLOORS: 2

▼ **Bedroom**
1st Floor

WIDTH: 2.75 m • LENGTH: 3.50 m
AREA: 9.62 m² • PERIMETER: 12.50 m

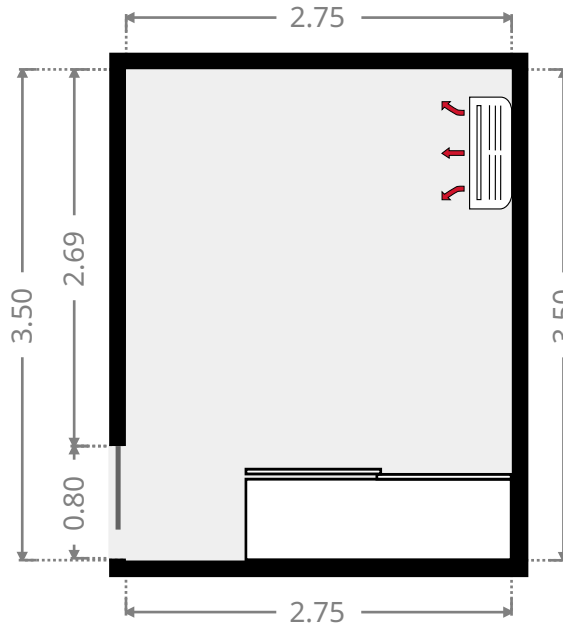
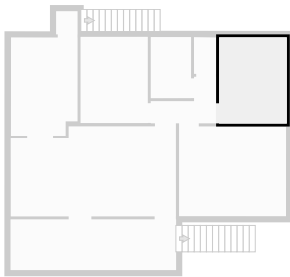

▼ **Master Bedroom**
1st Floor

WIDTH: 4.34 m • LENGTH: 3.64 m
AREA: 15.80 m² • PERIMETER: 15.96 m

