

Ground Floor

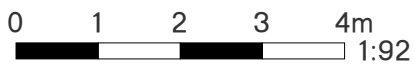
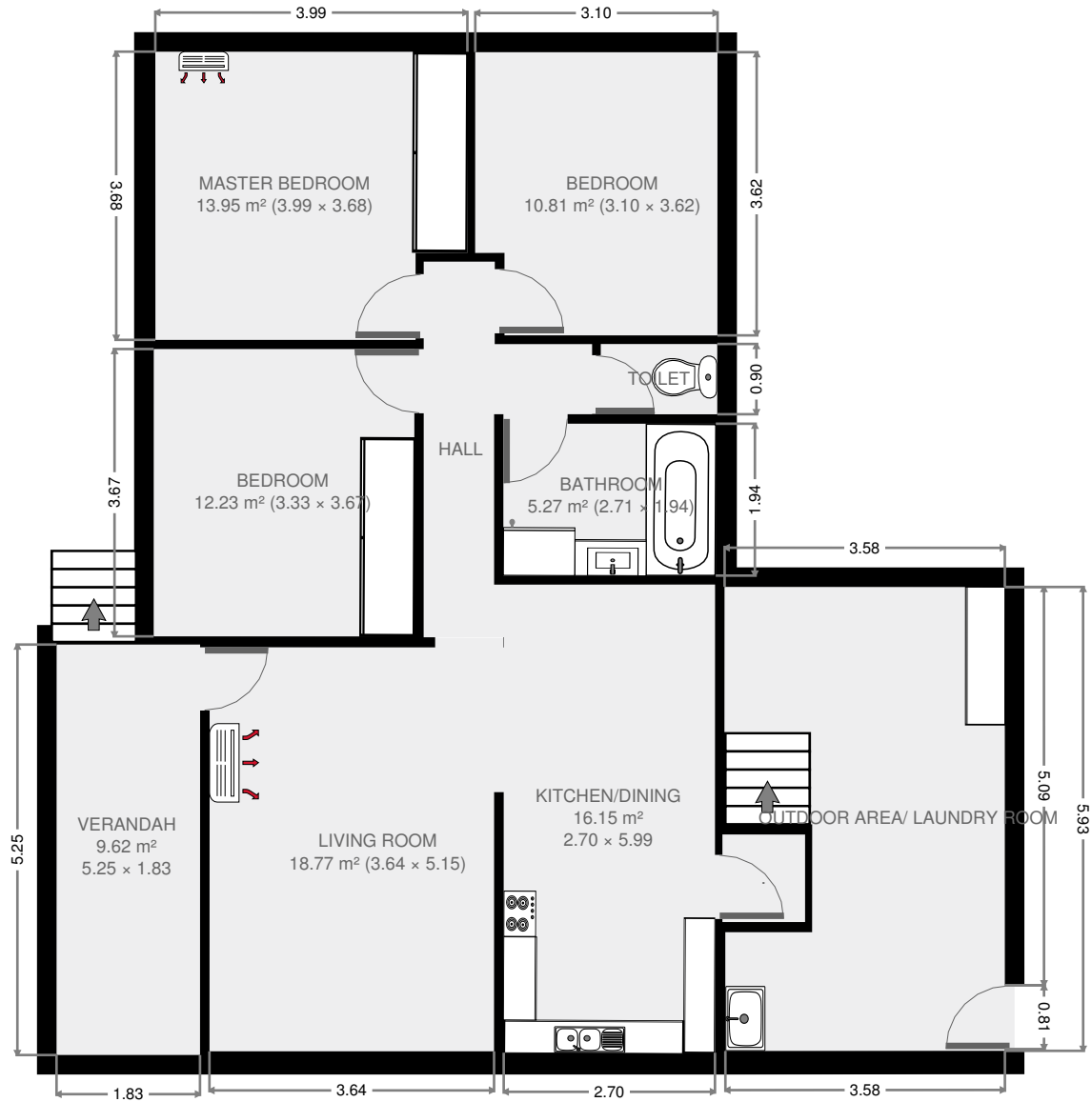

222 Horton Street

THIS FLOORPLAN IS PROVIDED WITHOUT WARRANTY OF ANY KIND. SENSOPIA DISCLAIMS ANY WARRANTY INCLUDING, WITHOUT LIMITATION, SATISFACTORY QUALITY OR ACCURACY OF DIMENSIONS.

Living Room

Width: 3.64 m
 Length: 5.15 m
 Area: 18.77 m²
 Perimeter: 17.60 m

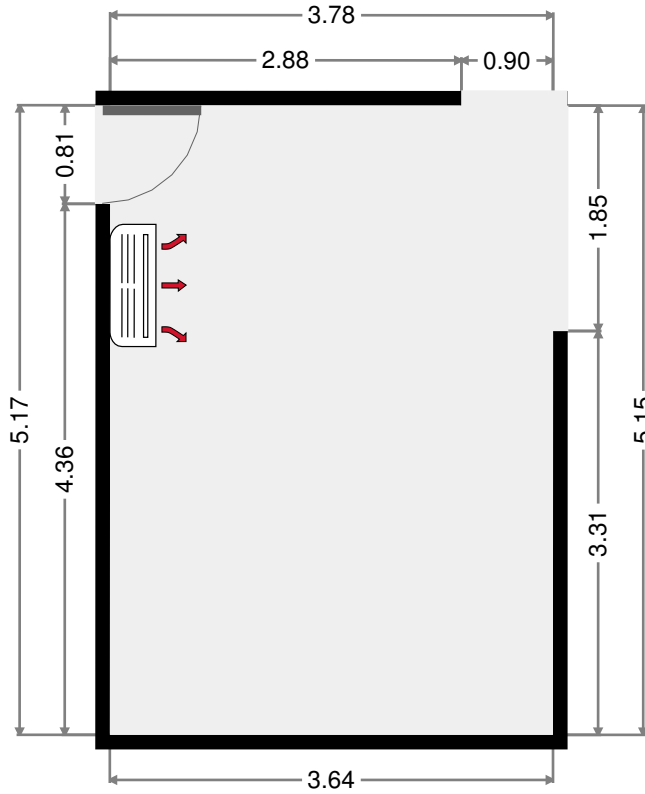
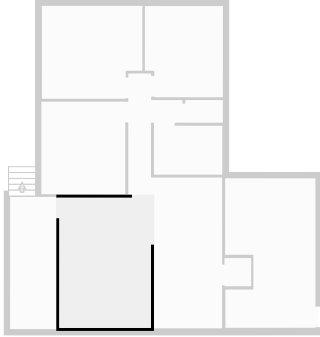

Kitchen/Dining

Width: 2.70 m
 Length: 5.99 m
 Area: 16.15 m²
 Perimeter: 17.36 m

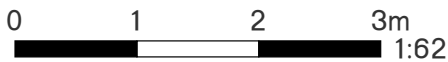
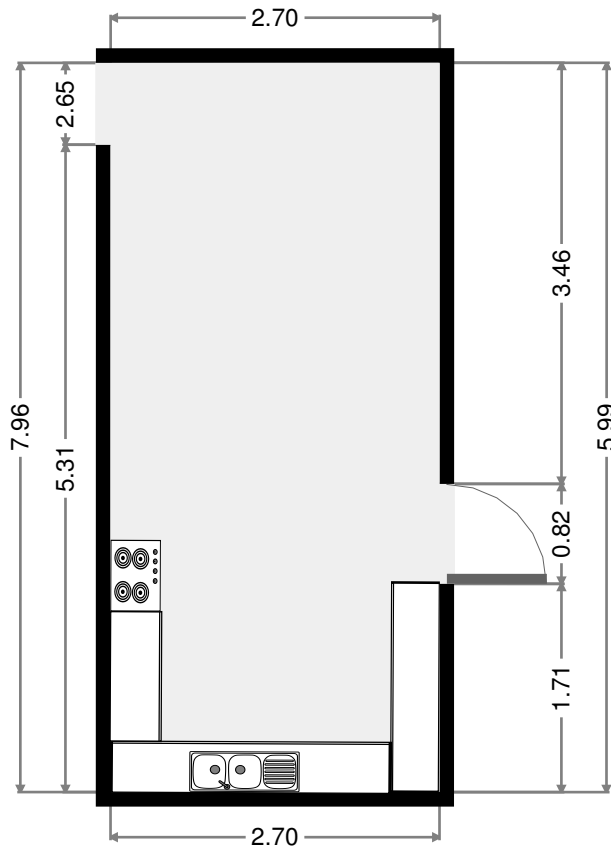
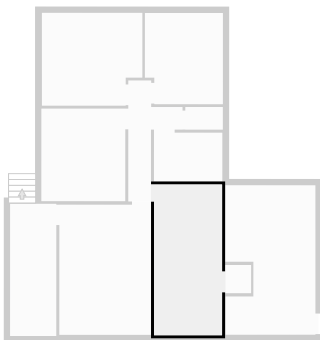

THIS FLOORPLAN IS PROVIDED WITHOUT WARRANTY OF ANY KIND. SENSOPIA DISCLAIMS ANY WARRANTY INCLUDING, WITHOUT LIMITATION, SATISFACTORY QUALITY OR ACCURACY OF DIMENSIONS.

Hall

Width: 2.15 m
 Length: 4.80 m
 Area: 5.45 m²
 Perimeter: 13.91 m

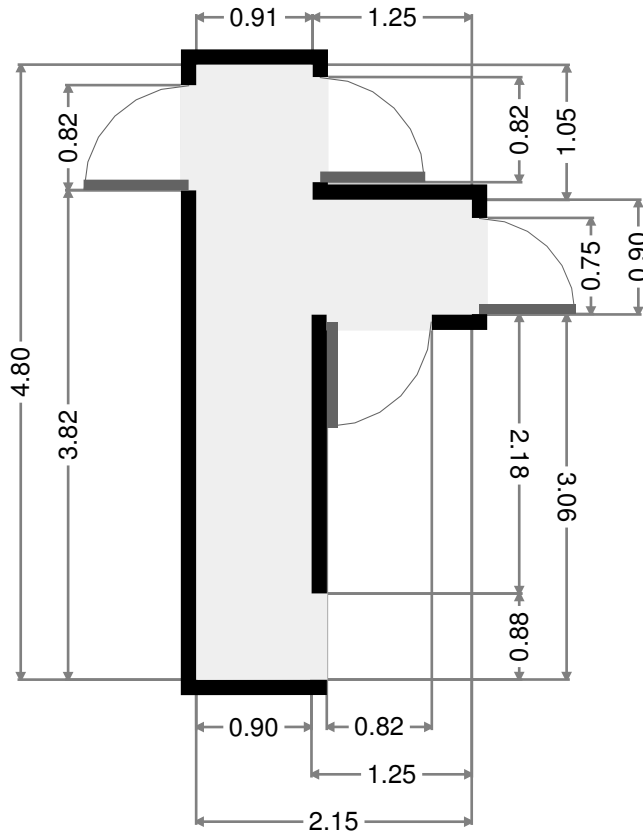
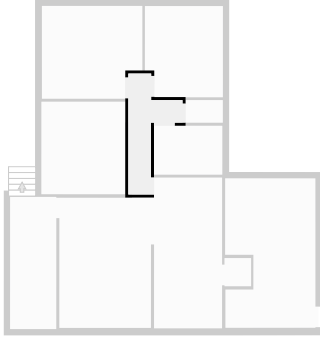

Bedroom

Width: 3.33 m
 Length: 3.67 m
 Area: 12.23 m²
 Perimeter: 14.00 m

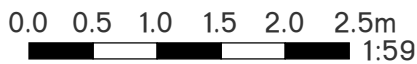
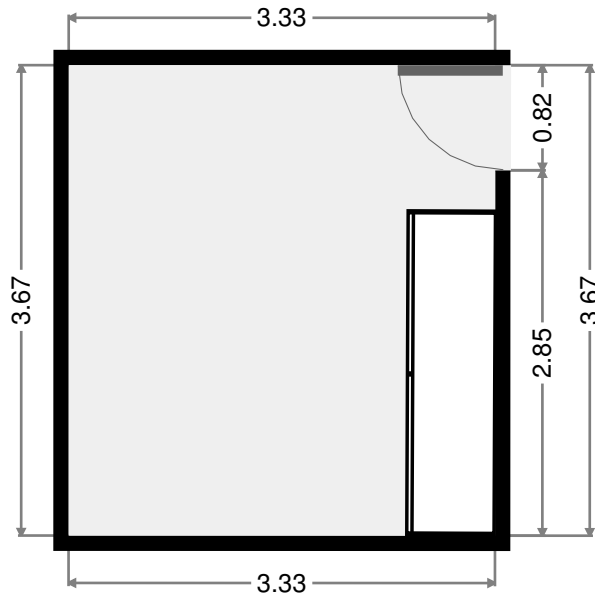
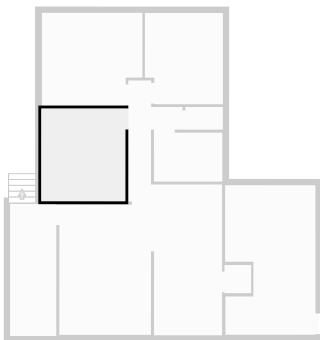

THIS FLOORPLAN IS PROVIDED WITHOUT WARRANTY OF ANY KIND. SENSOPIA DISCLAIMS ANY WARRANTY INCLUDING, WITHOUT LIMITATION, SATISFACTORY QUALITY OR ACCURACY OF DIMENSIONS.

Master Bedroom

Width: 3.68 m
 Length: 3.99 m
 Area: 13.95 m²
 Perimeter: 15.34 m

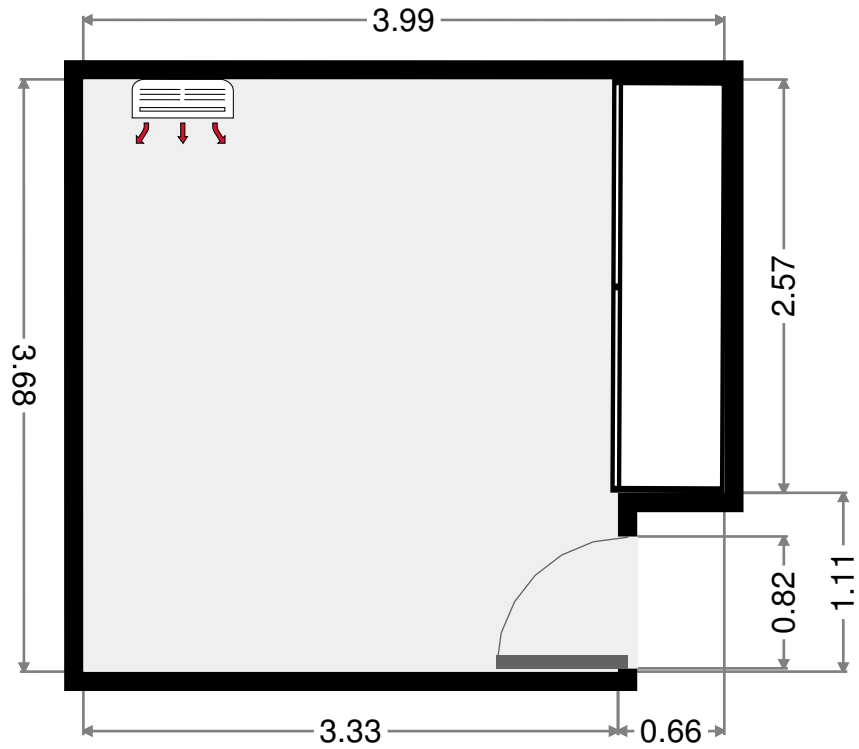
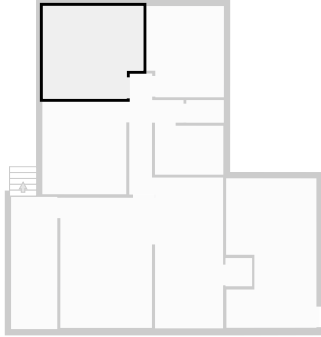

Bedroom

Width: 3.10 m
 Length: 3.62 m
 Area: 10.81 m²
 Perimeter: 13.43 m

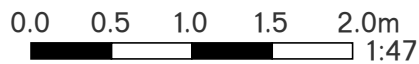
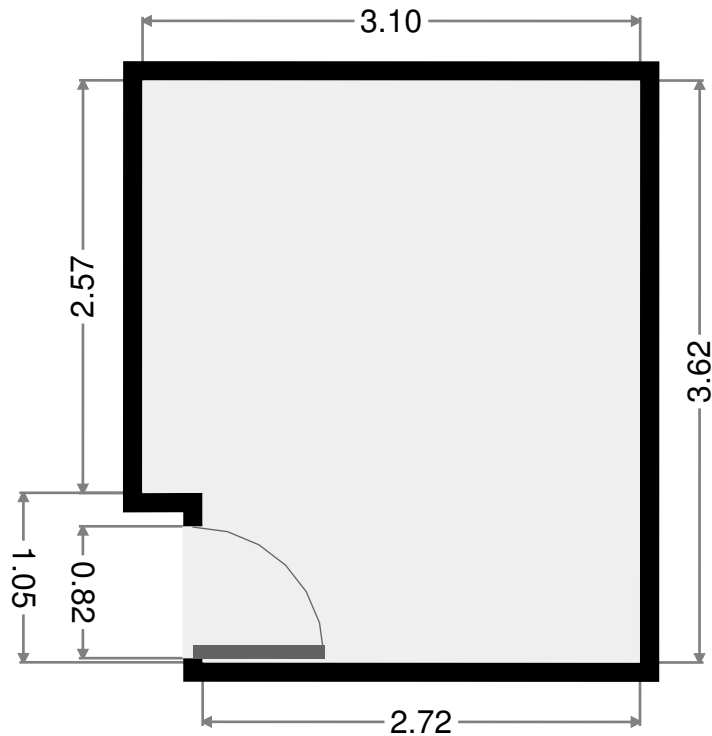
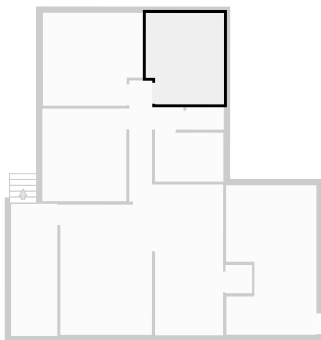

THIS FLOORPLAN IS PROVIDED WITHOUT WARRANTY OF ANY KIND. SENSOPIA DISCLAIMS ANY WARRANTY INCLUDING, WITHOUT LIMITATION, SATISFACTORY QUALITY OR ACCURACY OF DIMENSIONS.

Toilet

Width: 0.90 m
Length: 1.49 m
Area: 1.34 m²
Perimeter: 4.77 m

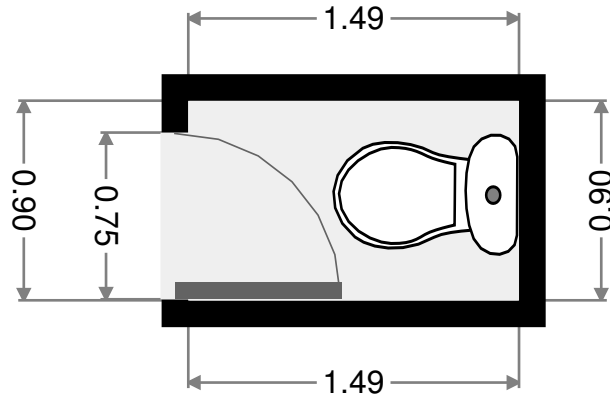
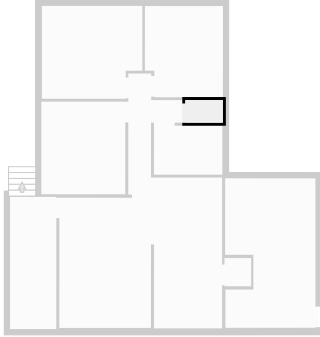

Bathroom

Width: 1.94 m
Length: 2.71 m
Area: 5.27 m²
Perimeter: 9.31 m

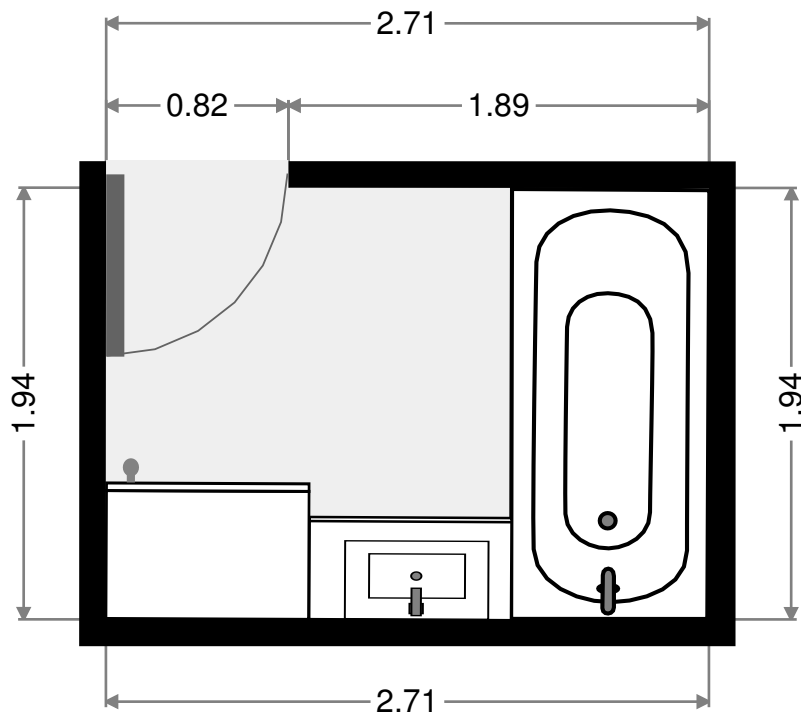
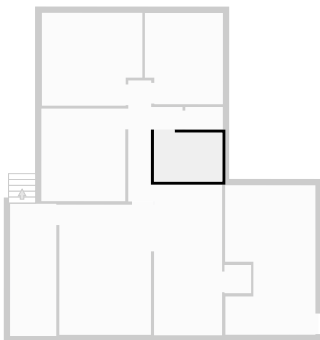

0.0 0.5 1.0 1.5m
1:34

THIS FLOORPLAN IS PROVIDED WITHOUT WARRANTY OF ANY KIND. SENSOPIA DISCLAIMS ANY WARRANTY INCLUDING, WITHOUT LIMITATION, SATISFACTORY QUALITY OR ACCURACY OF DIMENSIONS.

Verandah

Width: 1.83 m
Length: 5.25 m
Area: 9.62 m²
Perimeter: 14.16 m

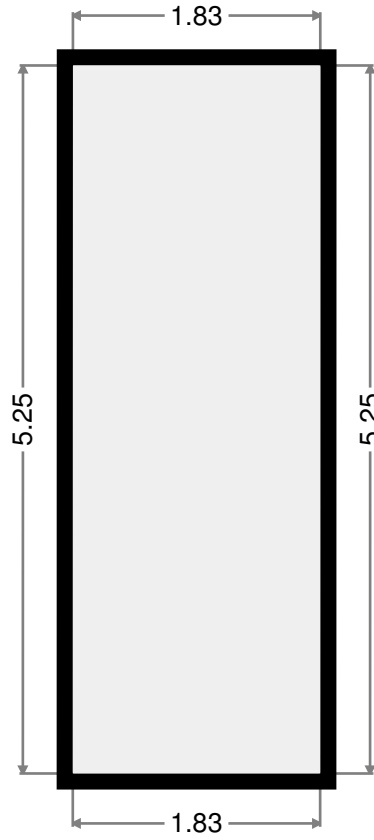
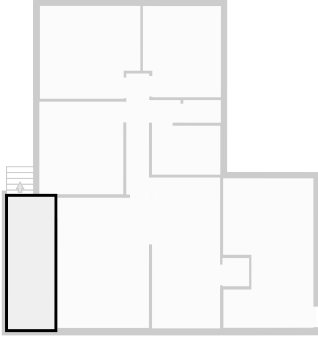

•
Width: 1.07 m
Length: 1.12 m
Area: 1.18 m²
Perimeter: 4.35 m

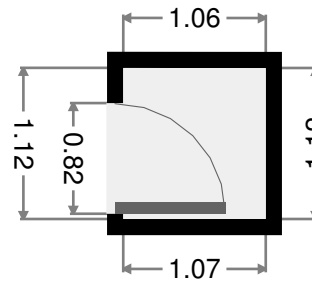

0.0 0.5 1.0 1.5 2.0 2.5m
1:56

THIS FLOORPLAN IS PROVIDED WITHOUT WARRANTY OF ANY KIND. SENSOPIA DISCLAIMS ANY WARRANTY INCLUDING, WITHOUT LIMITATION, SATISFACTORY QUALITY OR ACCURACY OF DIMENSIONS.

222 Horton Street

2017-05-11

Outdoor Area/ Laundry Room

Width: 3.58 m
Length: 5.93 m
Area: 19.68 m²
Perimeter: 21.24 m

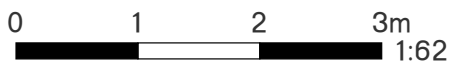
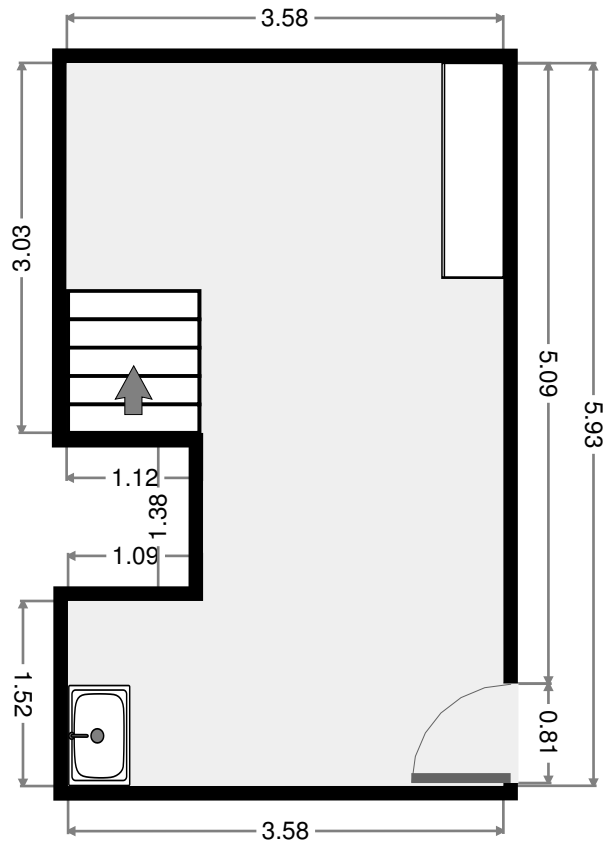

THIS FLOORPLAN IS PROVIDED WITHOUT WARRANTY OF ANY KIND. SENSOPIA DISCLAIMS ANY WARRANTY INCLUDING, WITHOUT LIMITATION, SATISFACTORY QUALITY OR ACCURACY OF DIMENSIONS.

222 Horton Street

2017-05-11