

22 Stickley Street

Ground Floor

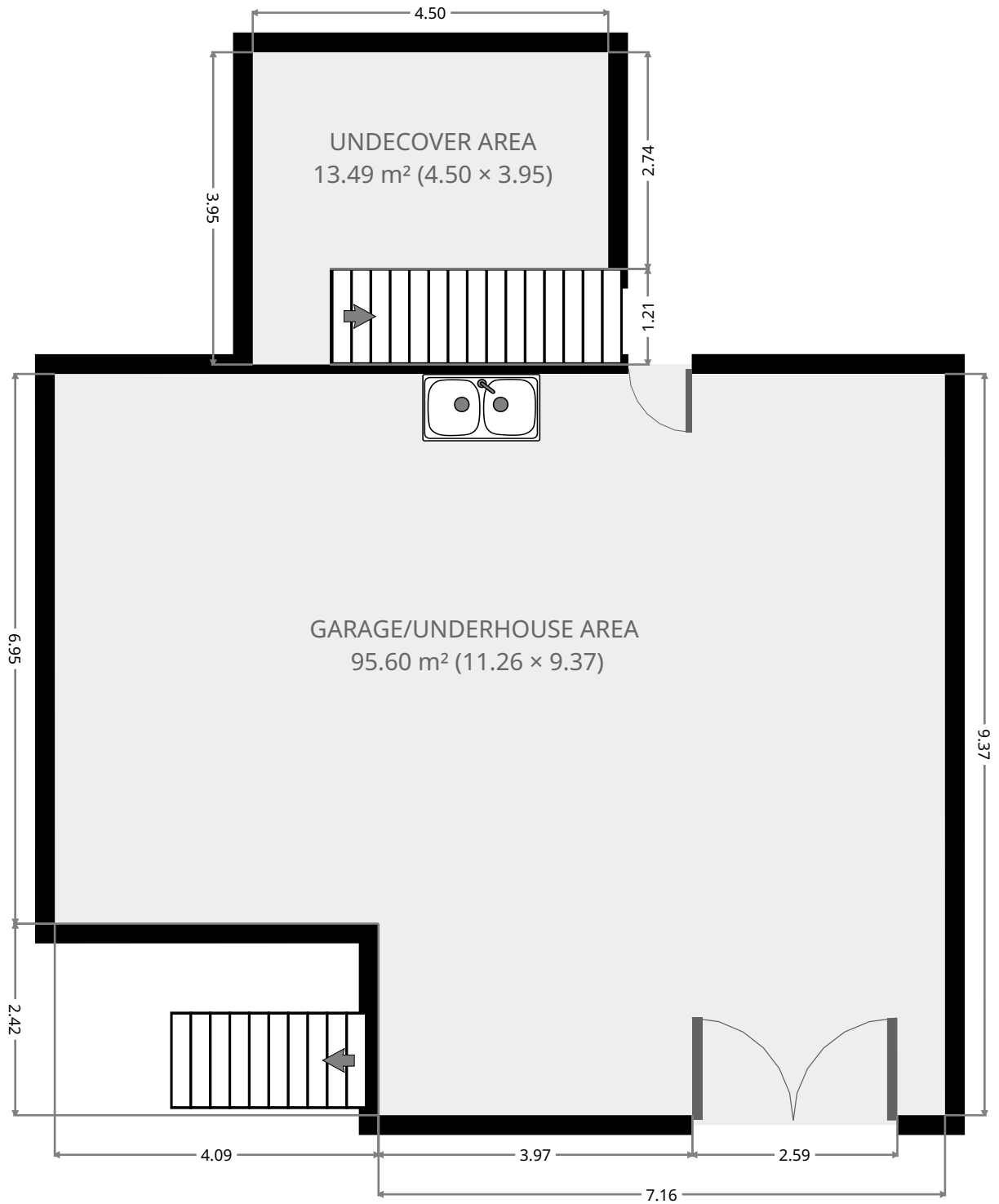

THIS FLOORPLAN IS PROVIDED WITHOUT WARRANTY OF ANY KIND. SENSOPIA DISCLAIMS ANY WARRANTY INCLUDING, WITHOUT LIMITATION, SATISFACTORY QUALITY OR ACCURACY OF DIMENSIONS.



22 Stickley Street

Garage/Underhouse Area

Width: 9.37 m
Length: 11.26 m
Area: 95.60 m²
Perimeter: 41.26 m

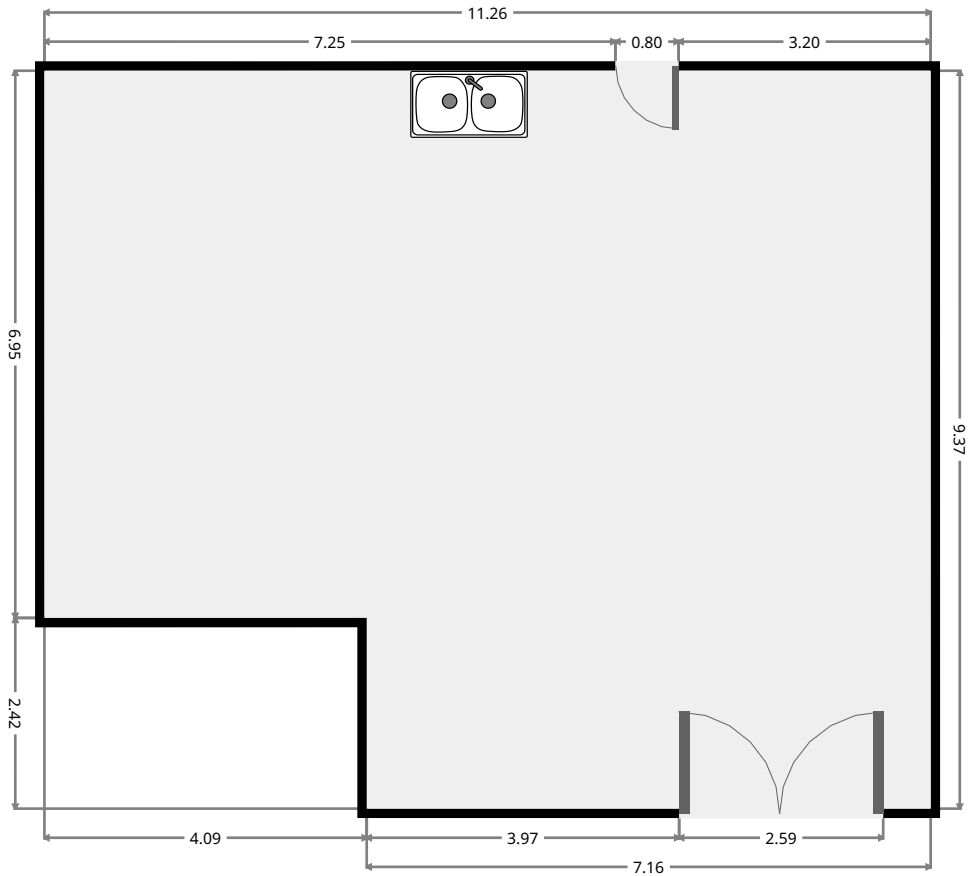
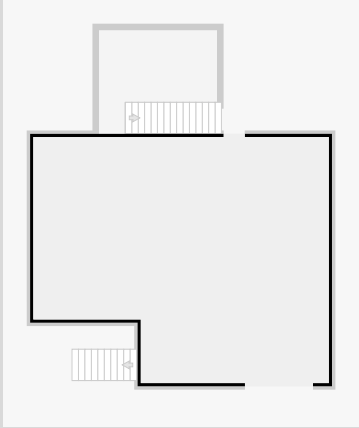

THIS FLOORPLAN IS PROVIDED WITHOUT WARRANTY OF ANY KIND. SENSOPIA DISCLAIMS ANY WARRANTY INCLUDING, WITHOUT LIMITATION, SATISFACTORY QUALITY OR ACCURACY OF DIMENSIONS.

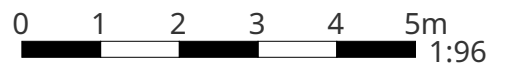

22 Stickley Street

Undecover Area

Width: 3.95 m
Length: 4.50 m
Area: 13.49 m²
Perimeter: 16.89 m

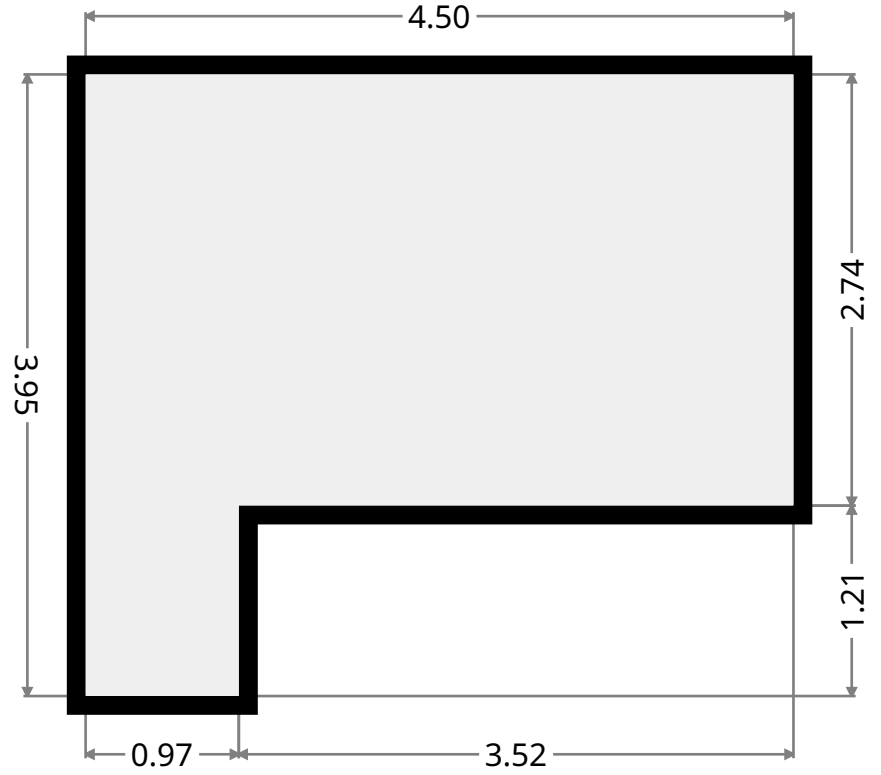
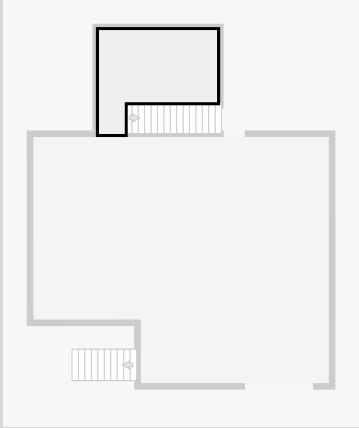

22 Stickley Street

1st Floor

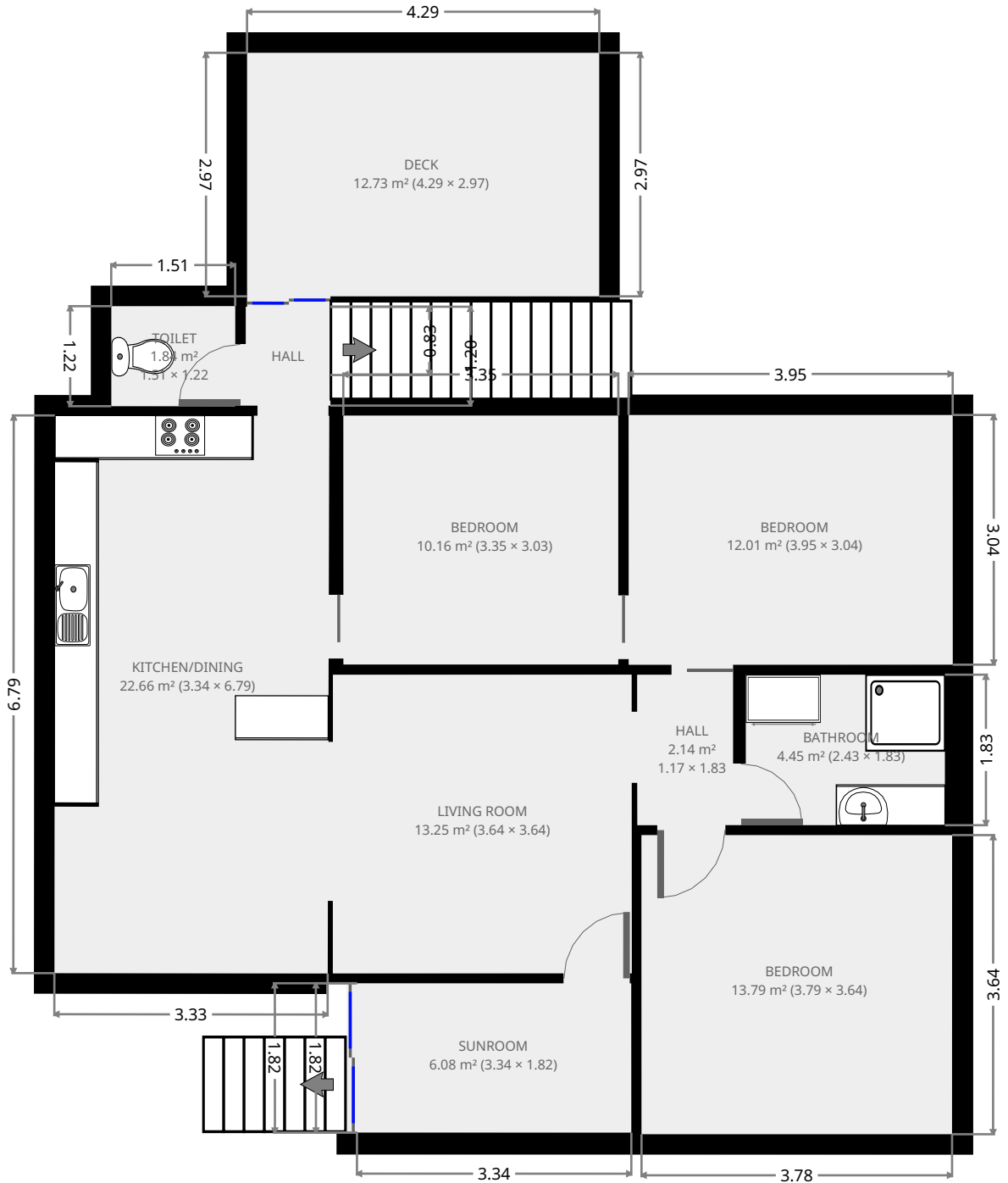

THIS FLOORPLAN IS PROVIDED WITHOUT WARRANTY OF ANY KIND. SENSOPIA DISCLAIMS ANY WARRANTY INCLUDING, WITHOUT LIMITATION, SATISFACTORY QUALITY OR ACCURACY OF DIMENSIONS.



22 Stickley Street

Sunroom

Width: 1.82 m
 Length: 3.34 m
 Area: 6.08 m²
 Perimeter: 10.32 m

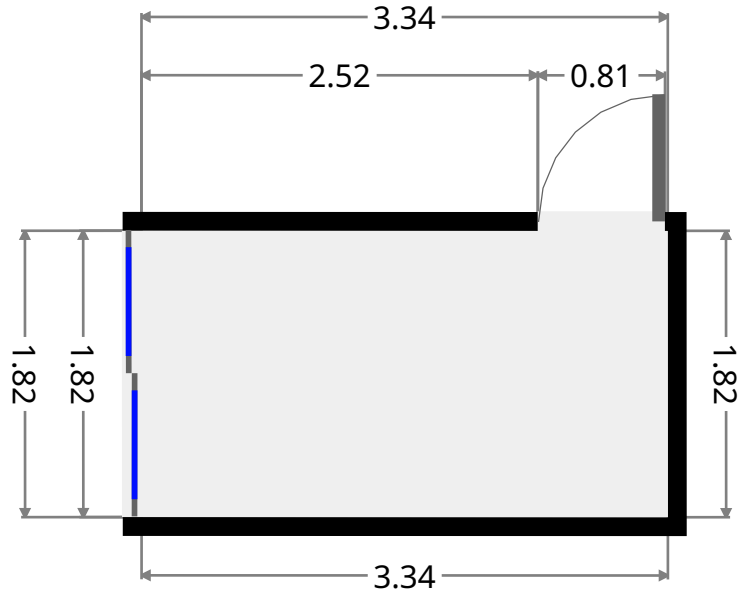
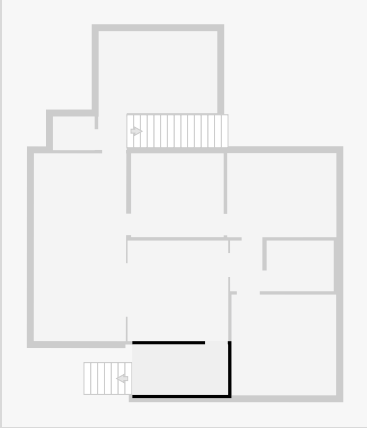

Living Room

Width: 3.64 m
 Length: 3.64 m
 Area: 13.25 m²
 Perimeter: 14.56 m

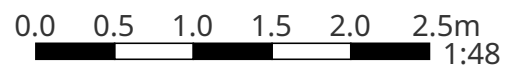
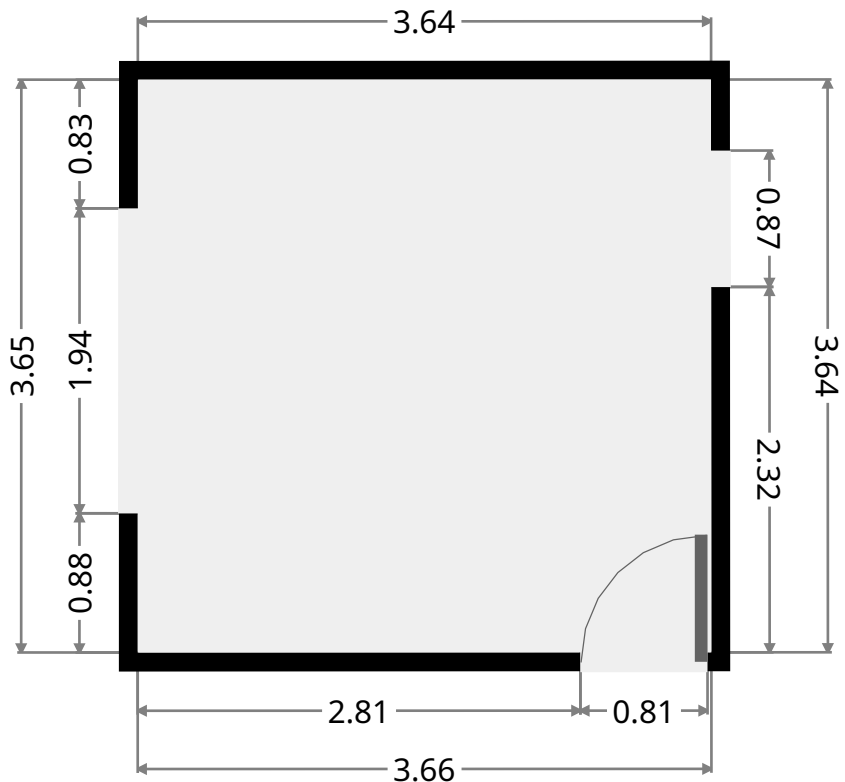
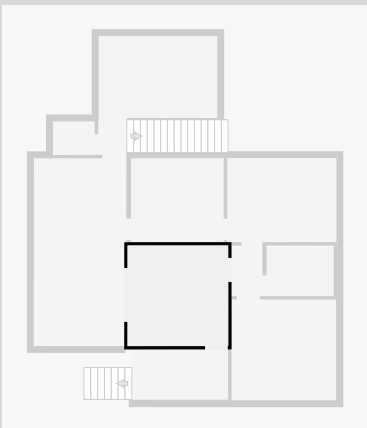

THIS FLOORPLAN IS PROVIDED WITHOUT WARRANTY OF ANY KIND. SENSOPIA DISCLAIMS ANY WARRANTY INCLUDING, WITHOUT LIMITATION, SATISFACTORY QUALITY OR ACCURACY OF DIMENSIONS.

22 Stickley Street

Kitchen/Dining

Width: 3.34 m
 Length: 6.79 m
 Area: 22.66 m²
 Perimeter: 20.26 m

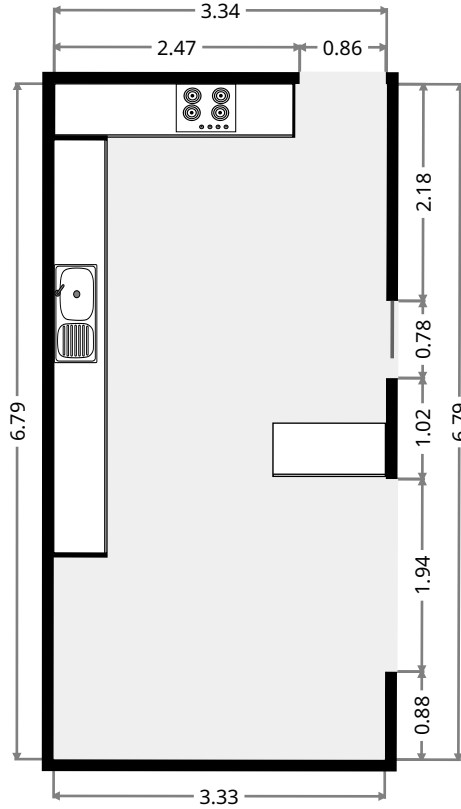
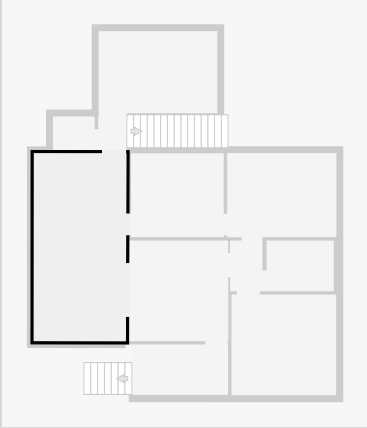

Bedroom

Width: 3.03 m
 Length: 3.35 m
 Area: 10.16 m²
 Perimeter: 12.77 m

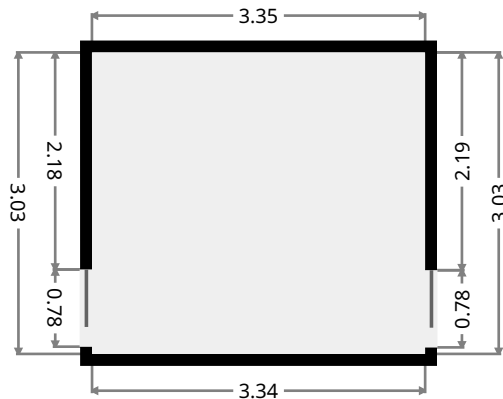
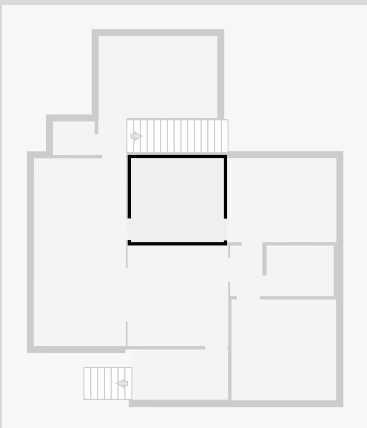

22 Stickley Street

Hall

Width: 1.03 m
Length: 1.20 m
Area: 1.24 m²
Perimeter: 4.47 m

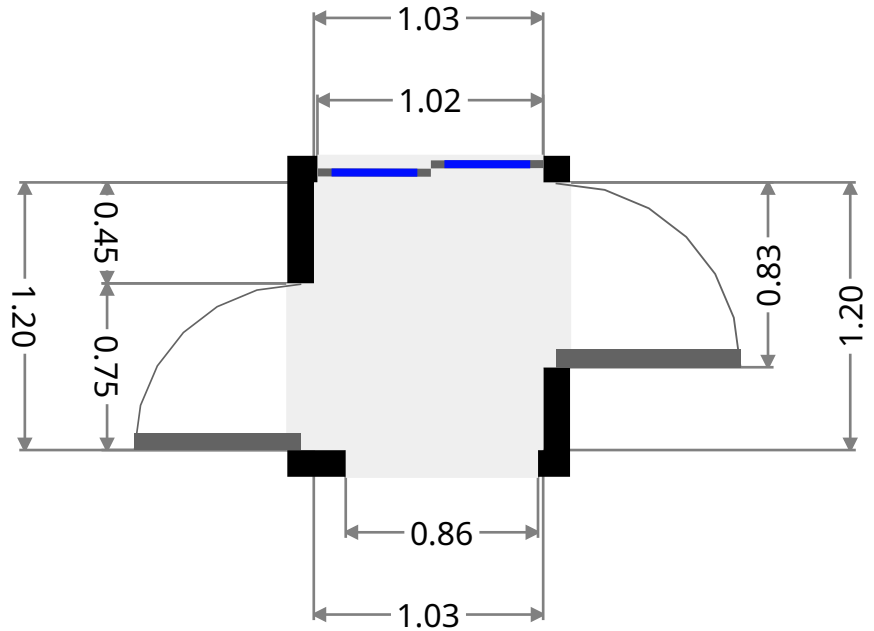
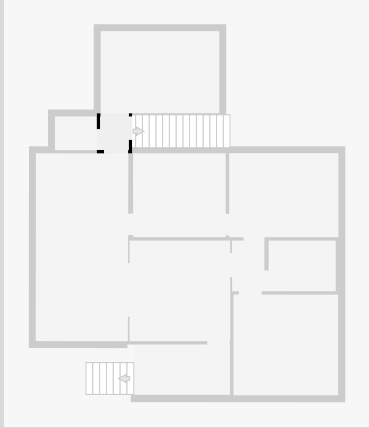

Toilet

Width: 1.22 m
Length: 1.51 m
Area: 1.84 m²
Perimeter: 5.46 m

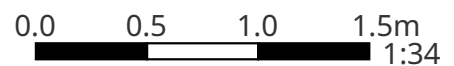
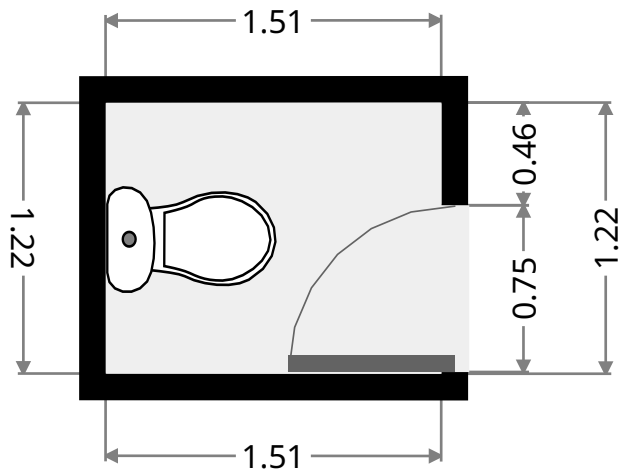
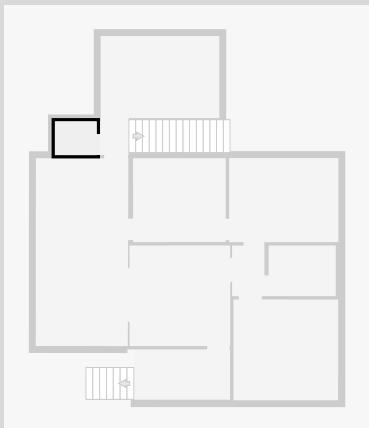

22 Stickley Street

Bedroom

Width: 3.04 m
 Length: 3.95 m
 Area: 12.01 m²
 Perimeter: 13.98 m

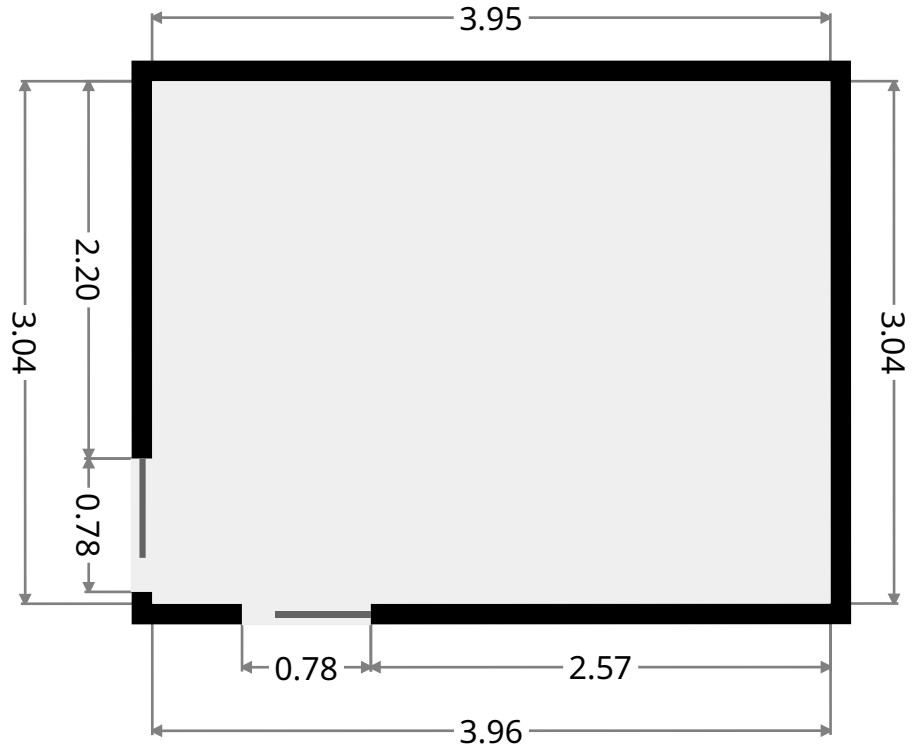
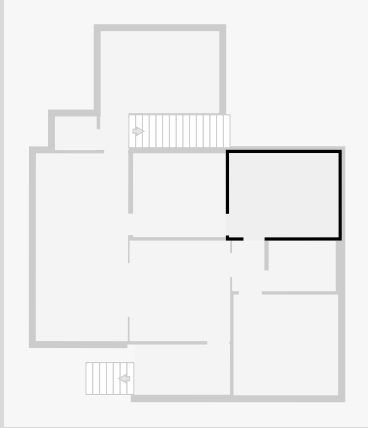

Hall

Width: 1.17 m
 Length: 1.83 m
 Area: 2.14 m²
 Perimeter: 6.00 m

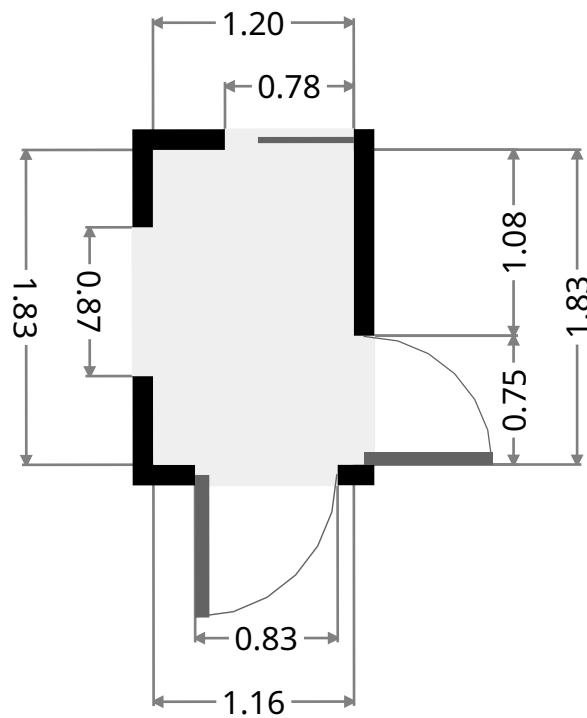
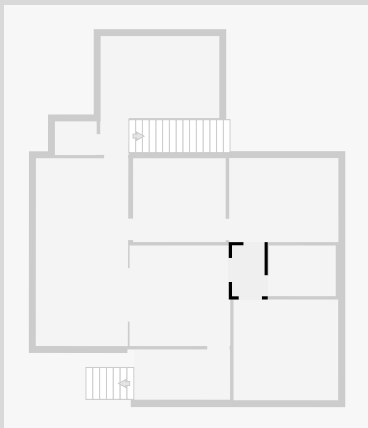

THIS FLOORPLAN IS PROVIDED WITHOUT WARRANTY OF ANY KIND. SENSOPIA DISCLAIMS ANY WARRANTY INCLUDING, WITHOUT LIMITATION, SATISFACTORY QUALITY OR ACCURACY OF DIMENSIONS.

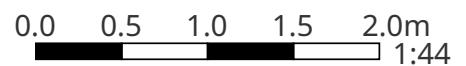

22 Stickley Street

Bedroom

Width: 3.64 m
Length: 3.79 m
Area: 13.79 m²
Perimeter: 14.86 m

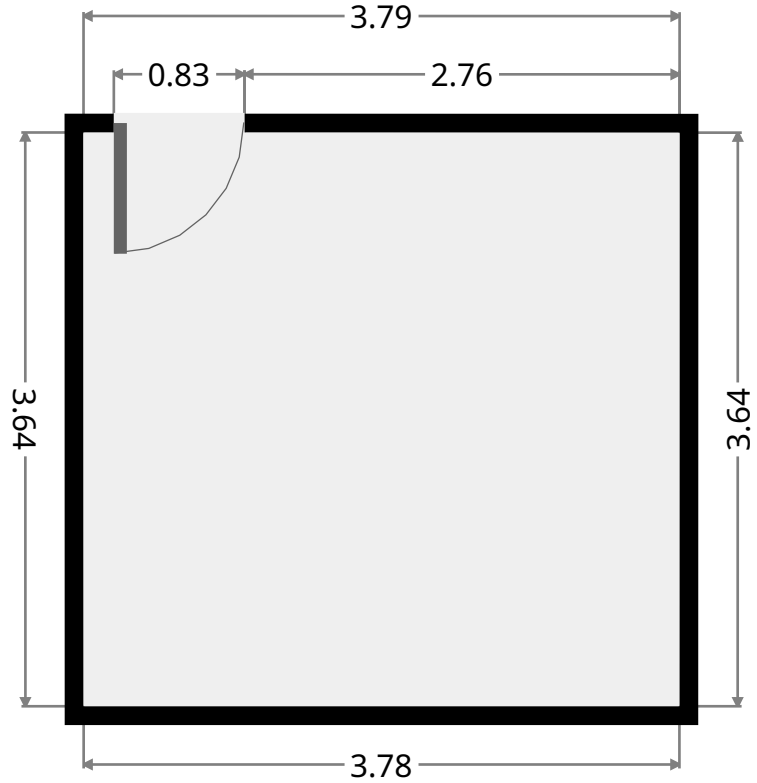
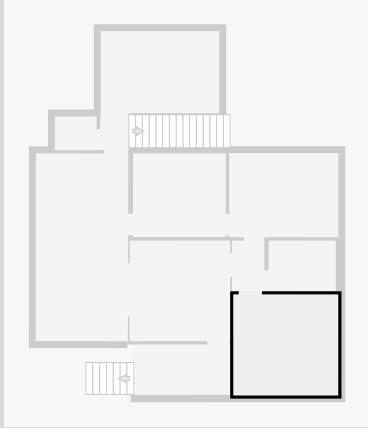

Bathroom

Width: 1.83 m
Length: 2.43 m
Area: 4.45 m²
Perimeter: 8.52 m

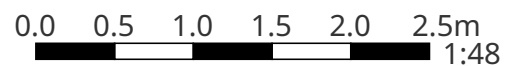
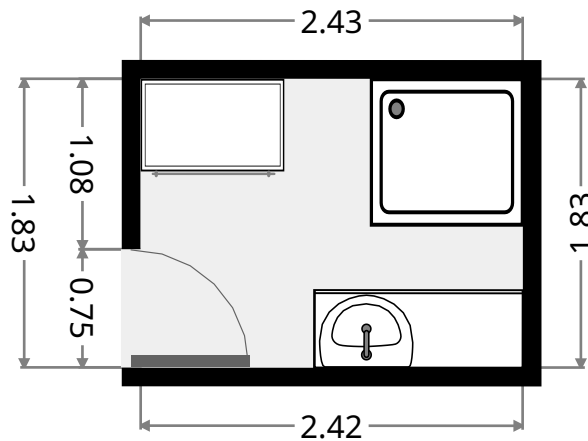
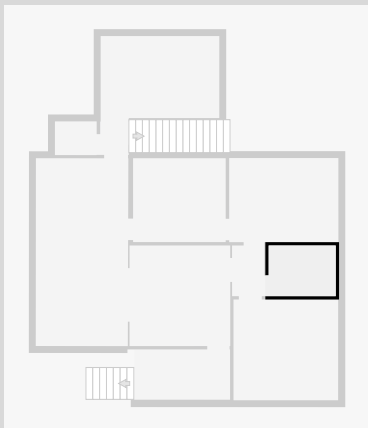

22 Stickley Street

Deck

Width: 2.97 m
Length: 4.29 m
Area: 12.73 m²
Perimeter: 14.52 m

