

22 Brazil Street

Created on
2021-09-28

Floors
2

▼ Ground Floor

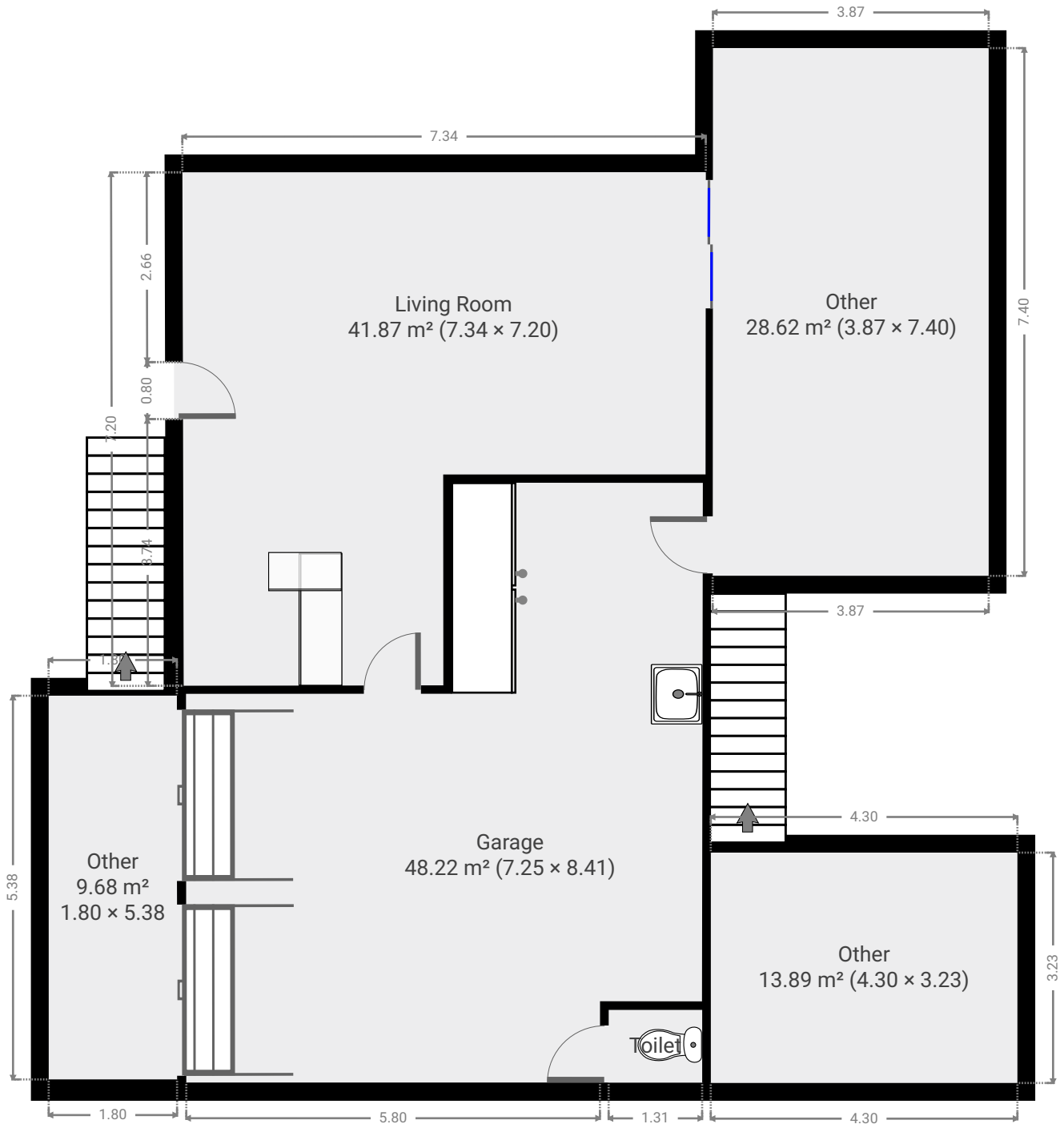

▼ **Garage**
Ground Floor

WIDTH: 8.41 m • LENGTH: 7.25 m
AREA: 48.22 m² • PERIMETER: 31.30 m

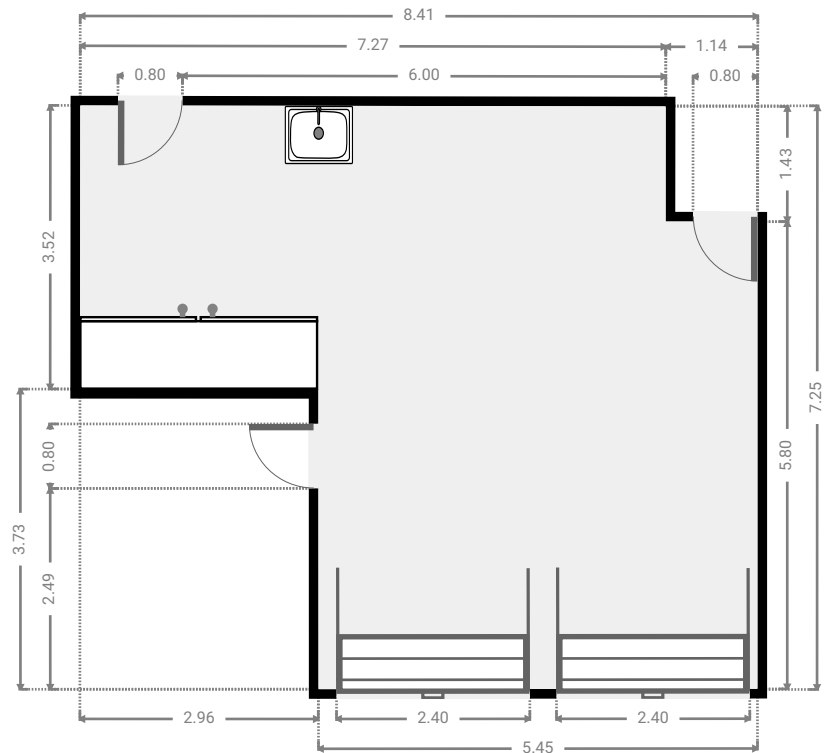
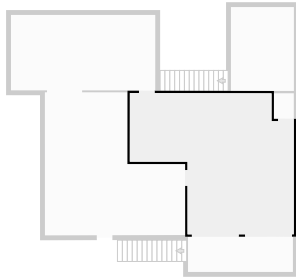

▼ **Toilet**
Ground Floor

WIDTH: 1.02 m • LENGTH: 1.31 m
AREA: 1.34 m² • PERIMETER: 4.66 m

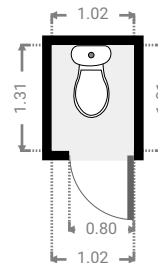
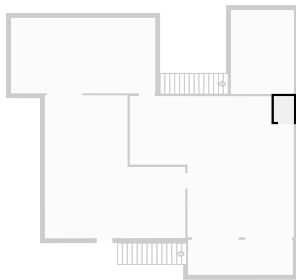

▼ Living Room
Ground Floor

WIDTH: 7.20 m • LENGTH: 7.34 m
AREA: 41.87 m² • PERIMETER: 29.06 m

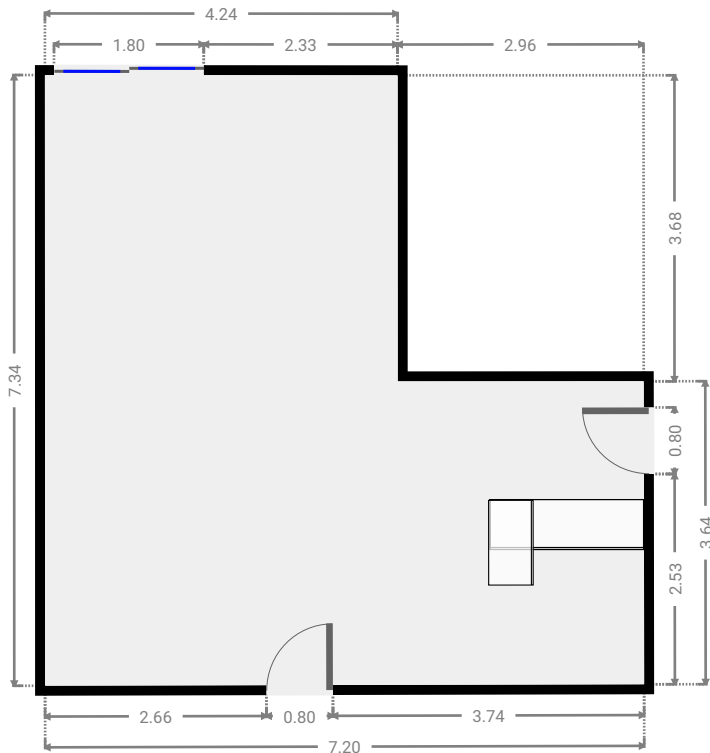
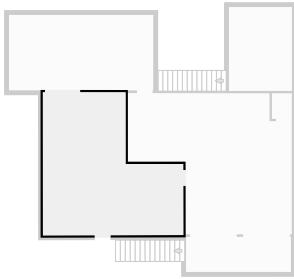

▼ Other
Ground Floor

WIDTH: 7.40 m • LENGTH: 3.87 m
AREA: 28.62 m² • PERIMETER: 22.54 m

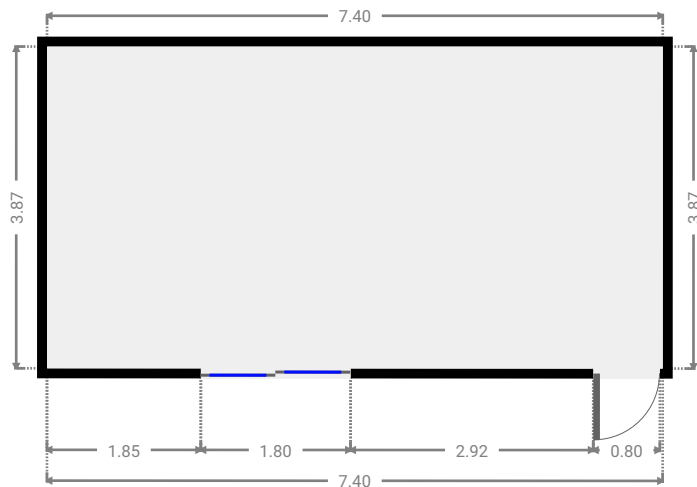
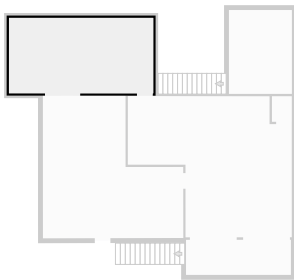

▼ Other Ground Floor

WIDTH: 3.23 m • LENGTH: 4.30 m
AREA: 13.89 m² • PERIMETER: 15.06 m

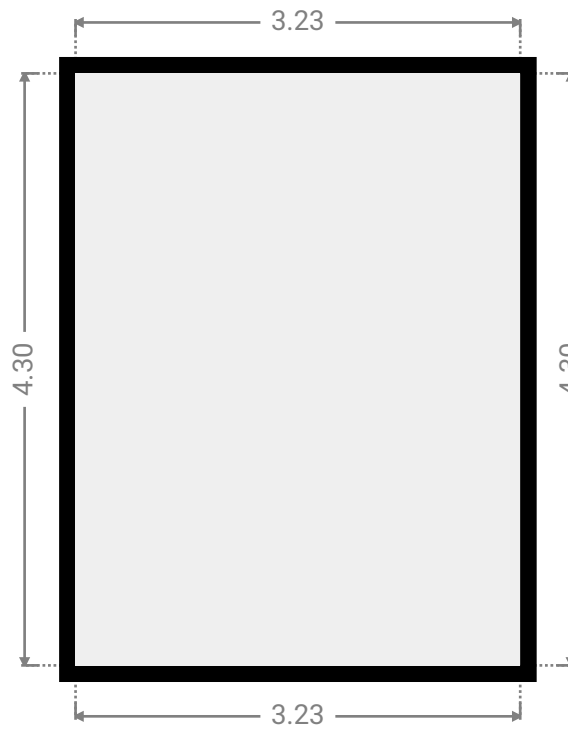
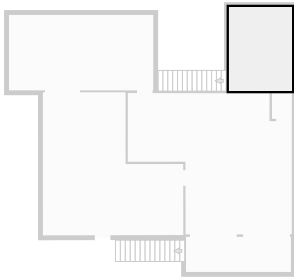

▼ Other Ground Floor

WIDTH: 5.38 m • LENGTH: 1.80 m
AREA: 9.68 m² • PERIMETER: 14.36 m

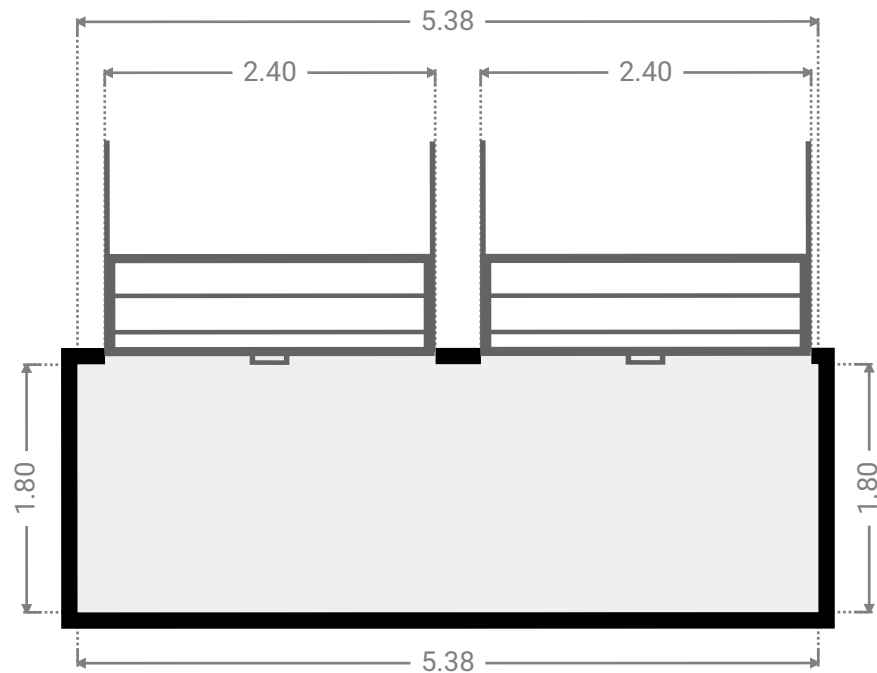
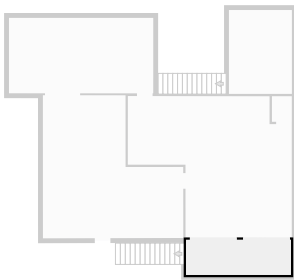

▼ 1st Floor



▼ Living Room
1st Floor

WIDTH: 4.80 m • LENGTH: 3.24 m
AREA: 15.56 m² • PERIMETER: 16.08 m

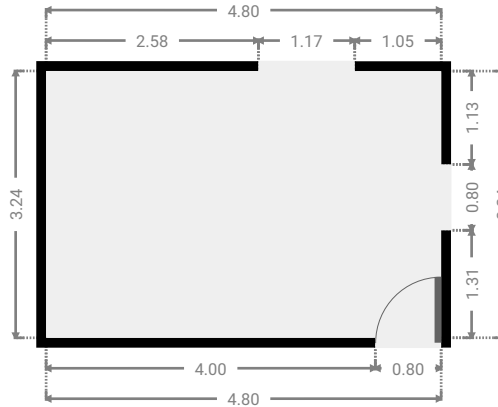
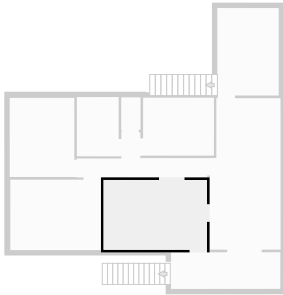

▼ Kitchen
1st Floor

WIDTH: 3.29 m • LENGTH: 7.03 m
AREA: 22.27 m² • PERIMETER: 20.64 m

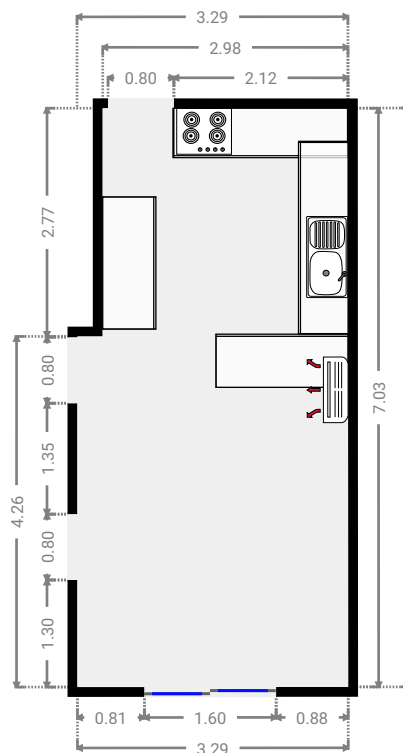
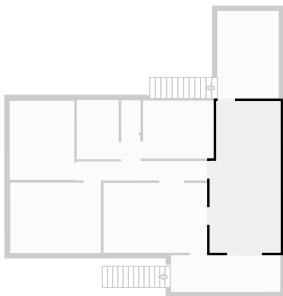

▼ **Bedroom**
1st Floor

WIDTH: 2.85 m • LENGTH: 4.06 m
AREA: 11.57 m² • PERIMETER: 13.82 m

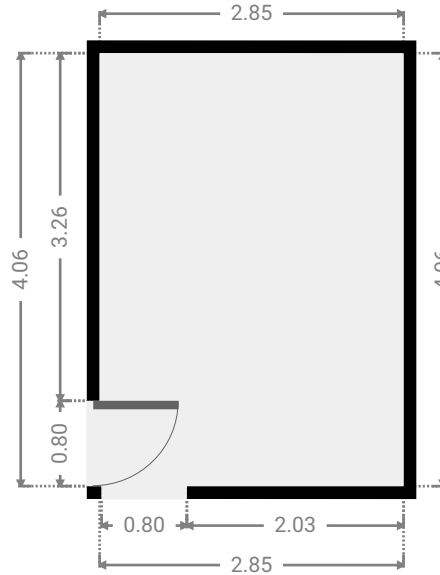
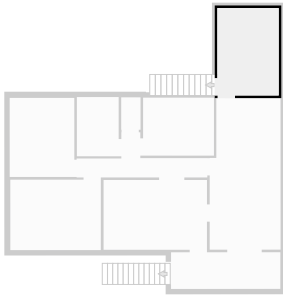

▼ **Hall**
1st Floor

WIDTH: 6.07 m • LENGTH: 2.10 m
AREA: 6.46 m² • PERIMETER: 16.33 m

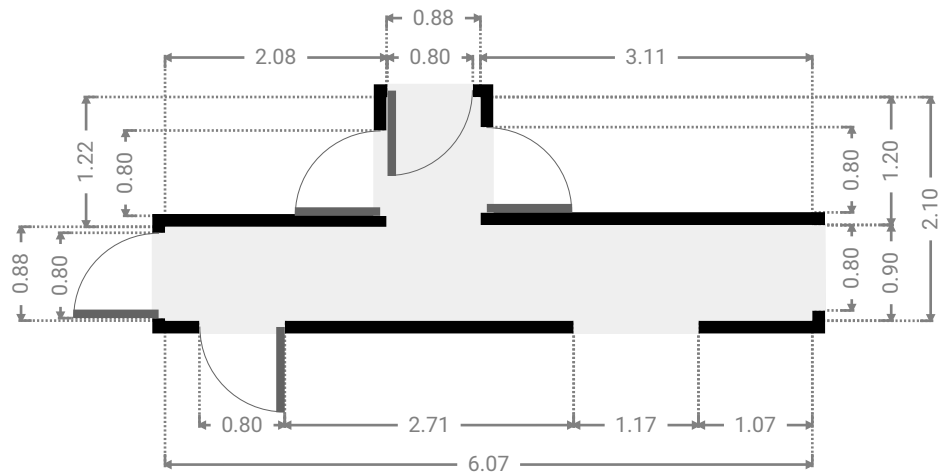
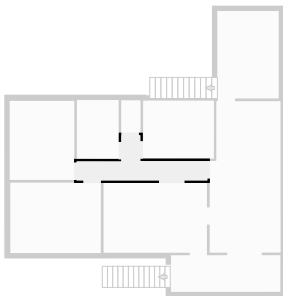

▼ Bedroom
1st Floor

WIDTH: 3.29 m • LENGTH: 2.69 m
AREA: 8.85 m² • PERIMETER: 11.96 m

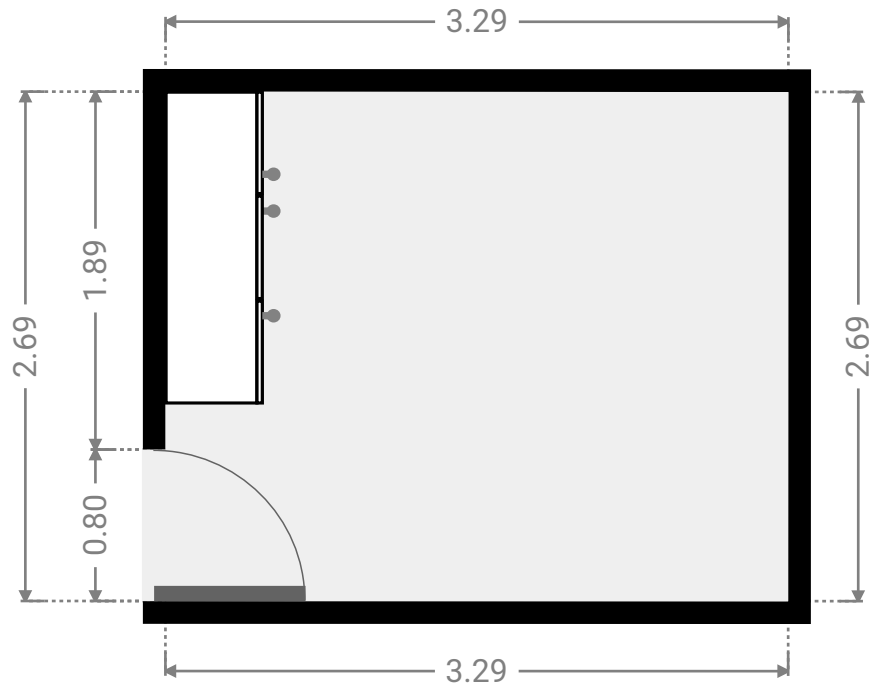
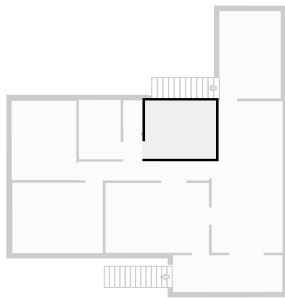

▼ Toilet
1st Floor

WIDTH: 0.90 m • LENGTH: 1.50 m
AREA: 1.35 m² • PERIMETER: 4.80 m

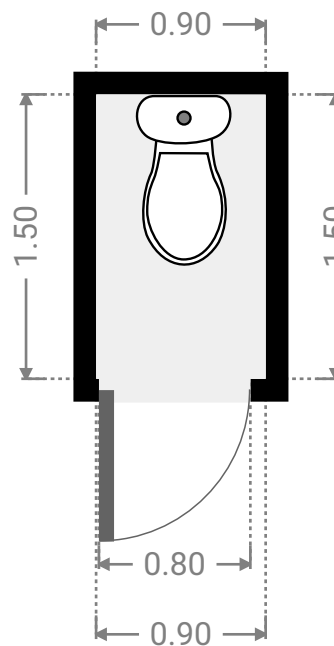
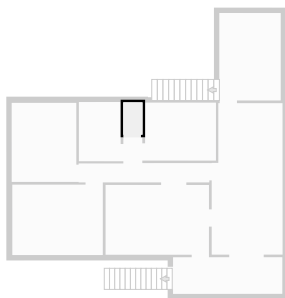

▼ **Bathroom**
1st Floor

WIDTH: 1.94 m • LENGTH: 2.75 m
AREA: 5.33 m² • PERIMETER: 9.38 m

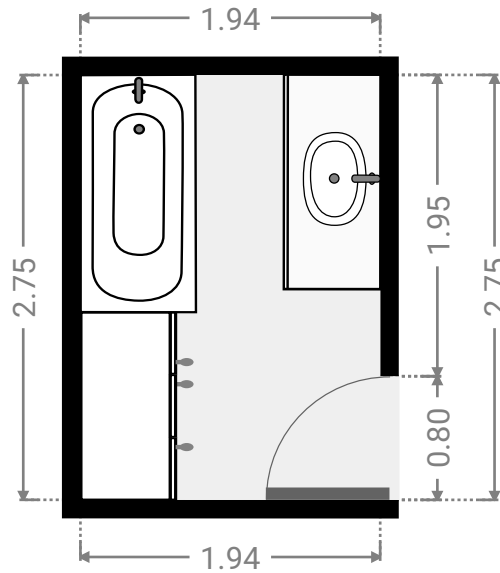
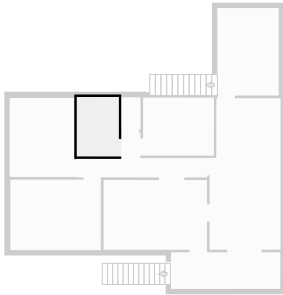

▼ **Bedroom**
1st Floor

WIDTH: 3.00 m • LENGTH: 3.67 m
AREA: 11.01 m² • PERIMETER: 13.34 m

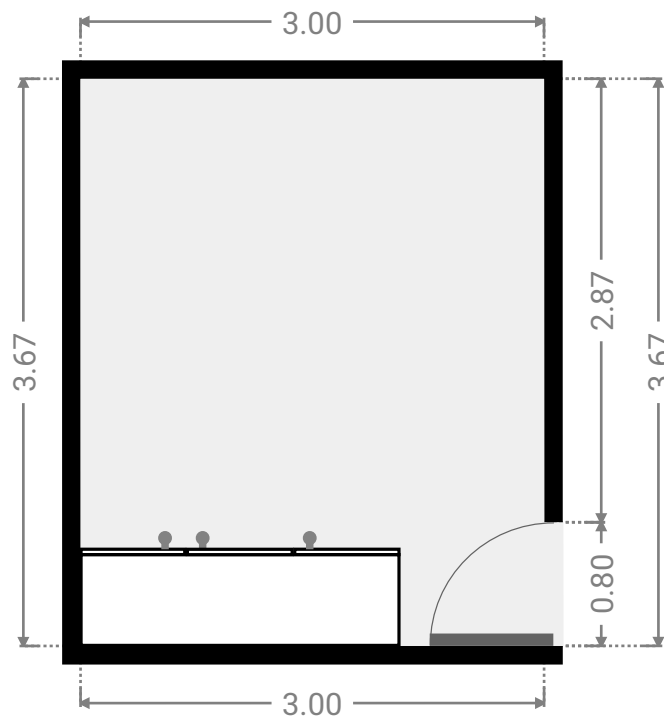
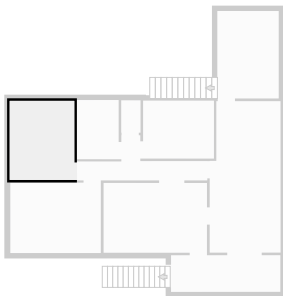

▼ **Bedroom**
1st Floor

WIDTH: 4.20 m • LENGTH: 3.27 m
AREA: 13.74 m² • PERIMETER: 14.94 m

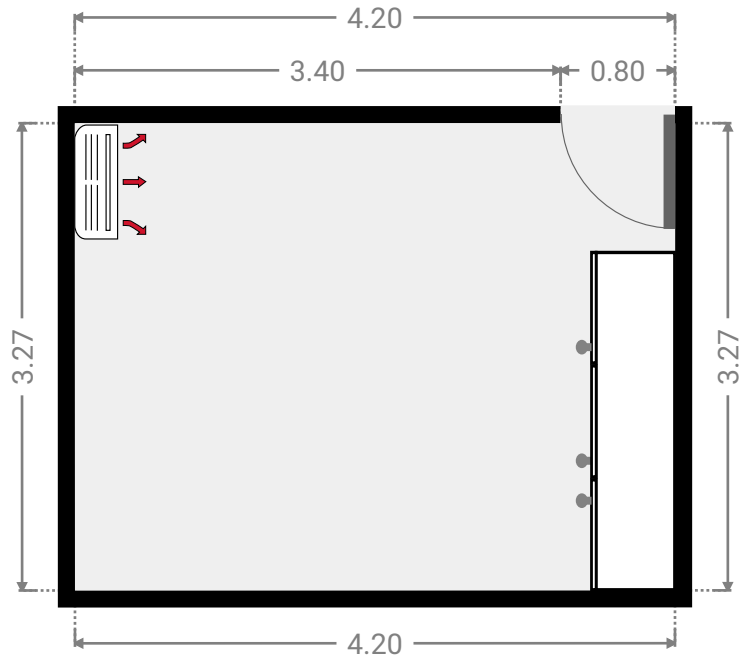
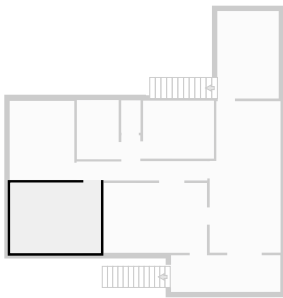

▼ **Other**
1st Floor

WIDTH: 5.08 m • LENGTH: 1.70 m
AREA: 8.63 m² • PERIMETER: 13.55 m

