

# 22/19 Schuffenhauer Street

## Ground Floor

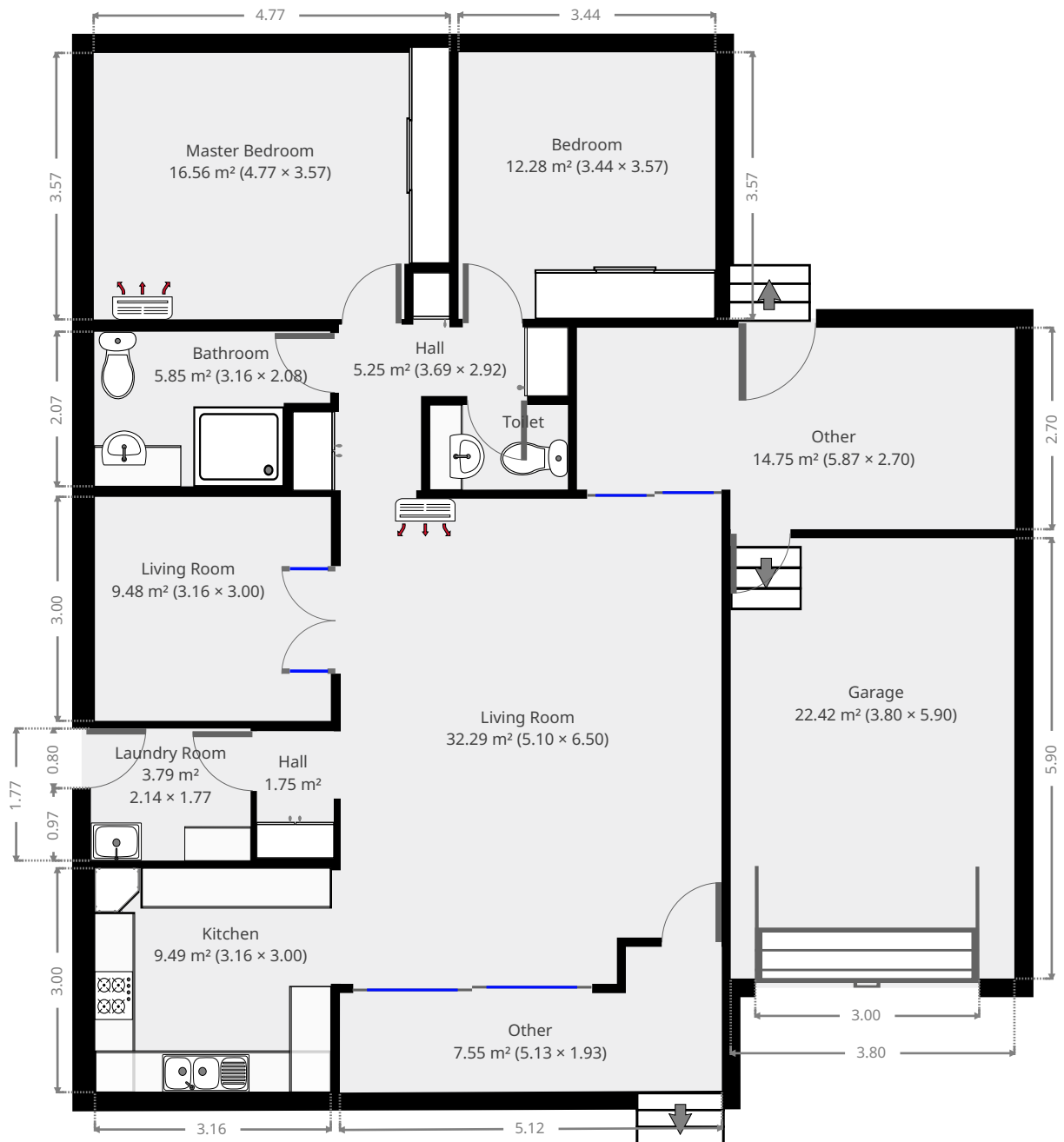

THIS FLOORPLAN IS PROVIDED WITHOUT WARRANTY OF ANY KIND. SENSOPIA DISCLAIMS ANY WARRANTY INCLUDING, WITHOUT LIMITATION, SATISFACTORY QUALITY OR ACCURACY OF DIMENSIONS.

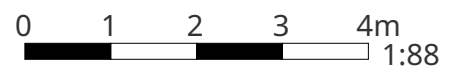

# 22/19 Schuffenhauer Street

## Living Room

Width: 5.10 m  
Length: 6.50 m  
Area: 32.29 m<sup>2</sup>  
Perimeter: 23.20 m

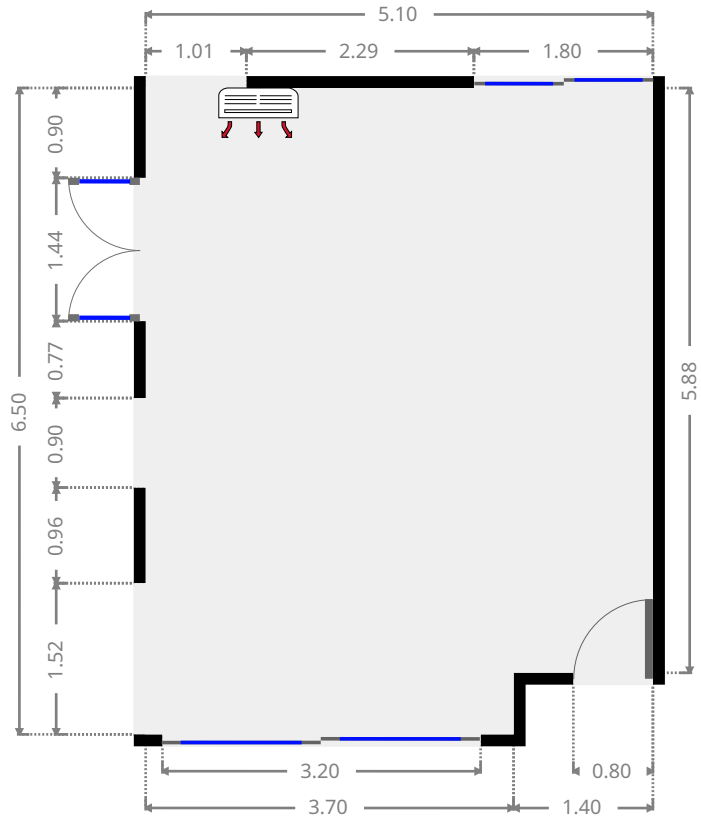
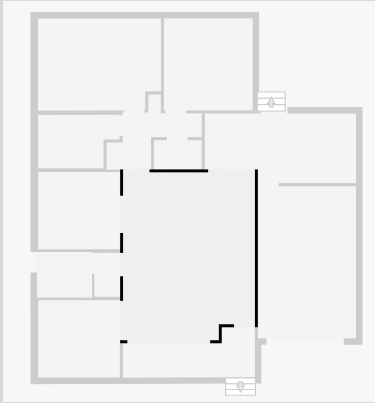

## Kitchen

Width: 3.00 m  
Length: 3.16 m  
Area: 9.49 m<sup>2</sup>  
Perimeter: 12.32 m

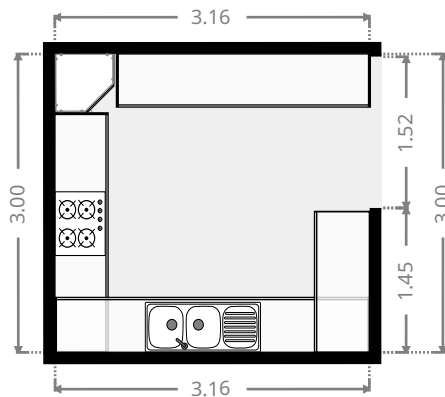

THIS FLOORPLAN IS PROVIDED WITHOUT WARRANTY OF ANY KIND. SENSOPIA DISCLAIMS ANY WARRANTY INCLUDING, WITHOUT LIMITATION, SATISFACTORY QUALITY OR ACCURACY OF DIMENSIONS.



# 22/19 Schuffenhauer Street

## Hall

Width: 1.03 m  
Length: 1.70 m  
Area: 1.75 m<sup>2</sup>  
Perimeter: 5.46 m

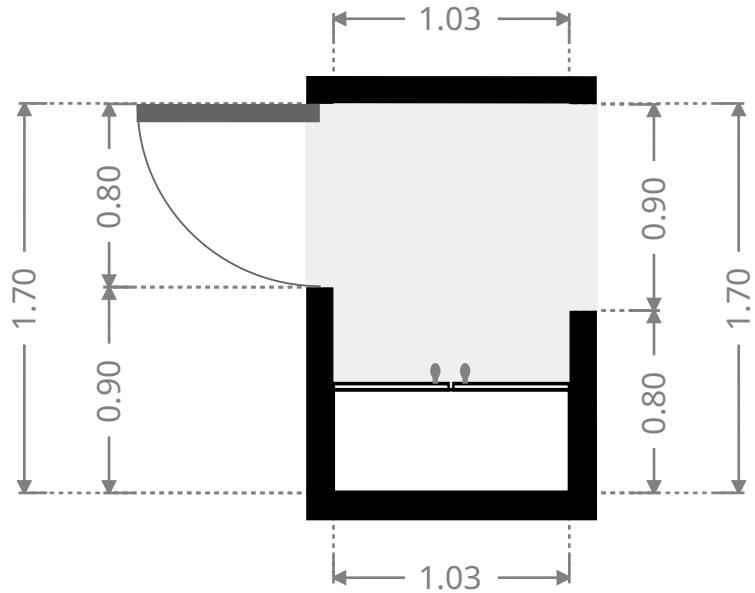
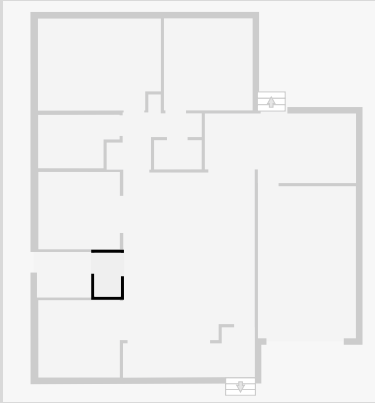

## Laundry Room

Width: 1.77 m  
Length: 2.14 m  
Area: 3.79 m<sup>2</sup>  
Perimeter: 7.82 m

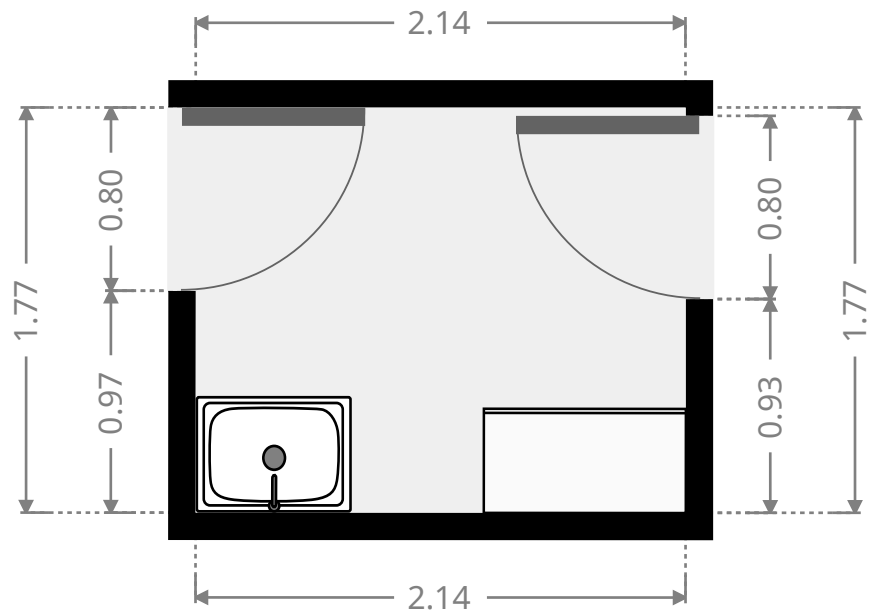
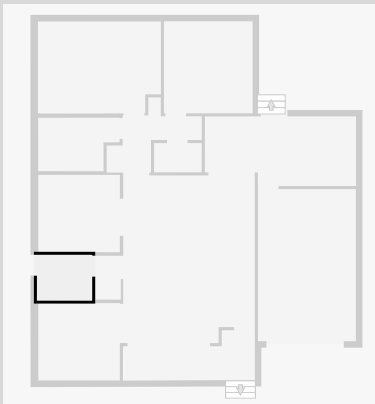

THIS FLOORPLAN IS PROVIDED WITHOUT WARRANTY OF ANY KIND. SENSOPIA DISCLAIMS ANY WARRANTY INCLUDING, WITHOUT LIMITATION, SATISFACTORY QUALITY OR ACCURACY OF DIMENSIONS.

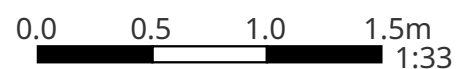

# 22/19 Schuffenhauer Street

## Living Room

Width: 3.00 m  
 Length: 3.16 m  
 Area: 9.48 m<sup>2</sup>  
 Perimeter: 12.32 m

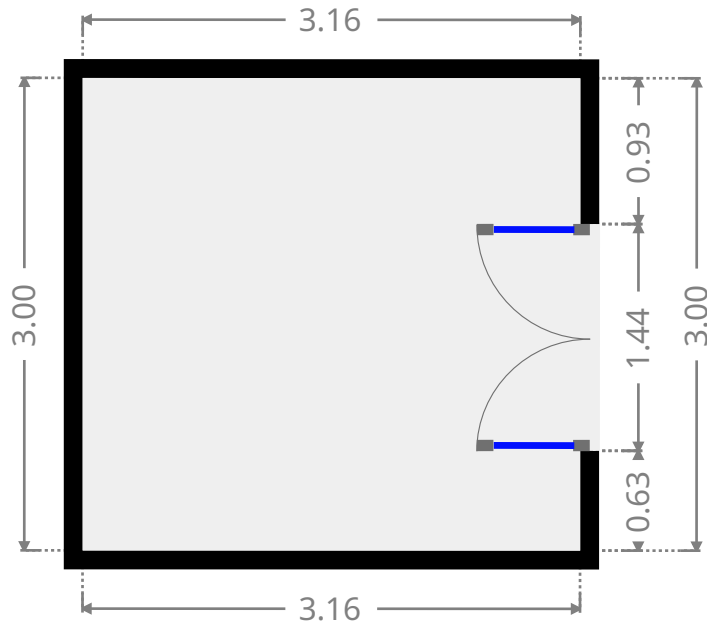
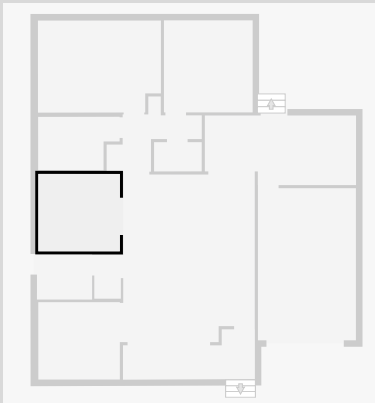

## Hall

Width: 2.92 m  
 Length: 3.69 m  
 Area: 5.25 m<sup>2</sup>  
 Perimeter: 13.21 m

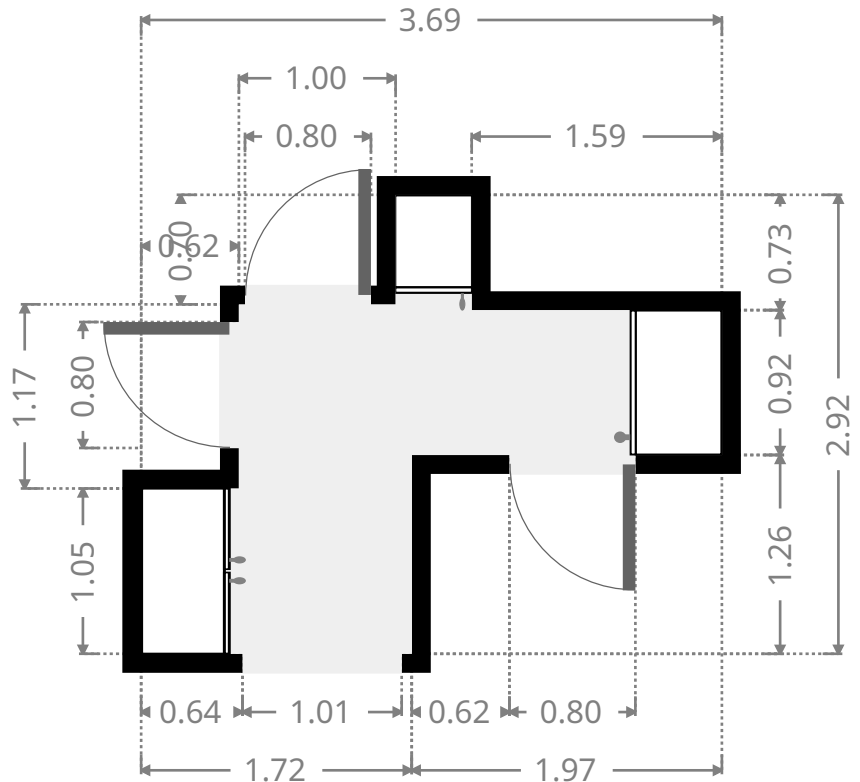
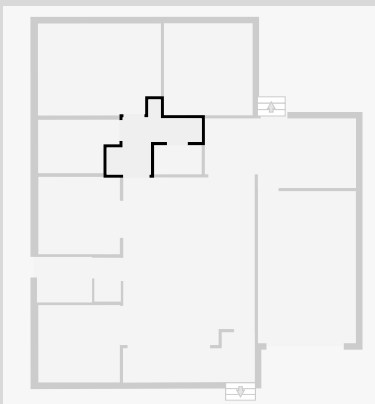

THIS FLOORPLAN IS PROVIDED WITHOUT WARRANTY OF ANY KIND. SENSOPIA DISCLAIMS ANY WARRANTY INCLUDING, WITHOUT LIMITATION, SATISFACTORY QUALITY OR ACCURACY OF DIMENSIONS.

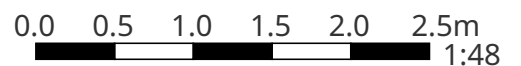

# 22/19 Schuffenhauer Street

## Bathroom

Width: 2.08 m  
Length: 3.16 m  
Area: 5.85 m<sup>2</sup>  
Perimeter: 10.46 m

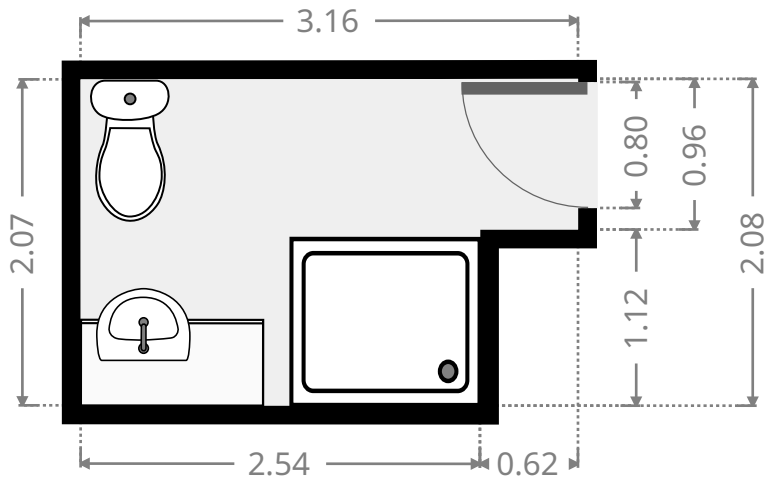
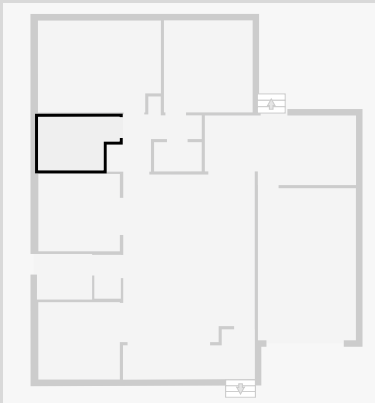

## Master Bedroom

Width: 3.57 m  
Length: 4.77 m  
Area: 16.56 m<sup>2</sup>  
Perimeter: 16.67 m

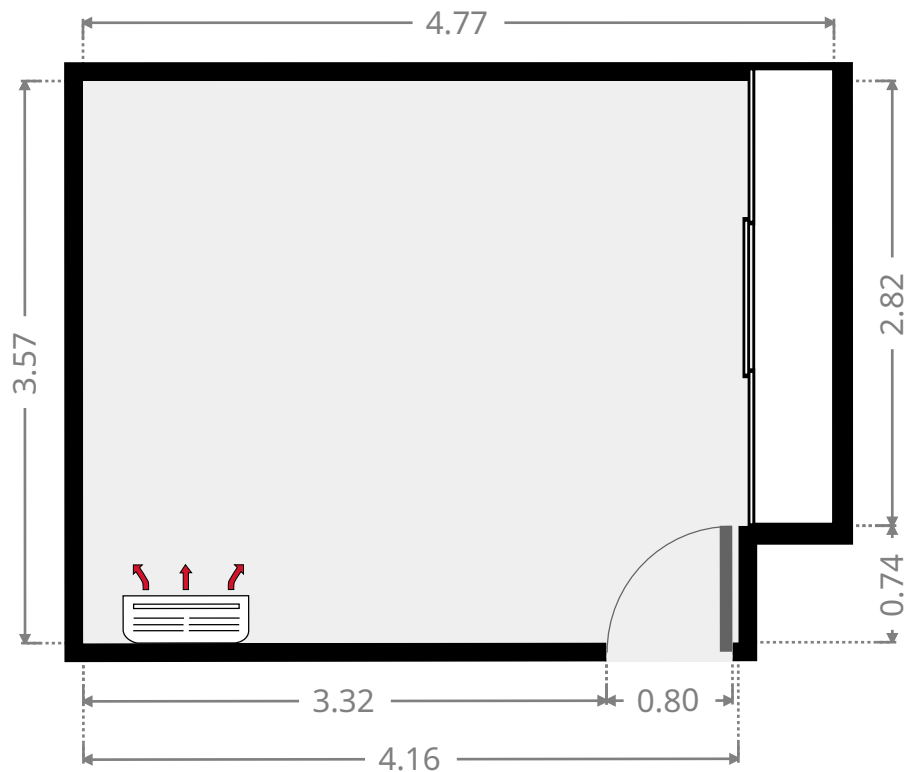
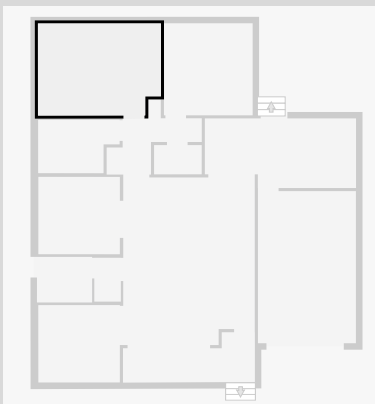

THIS FLOORPLAN IS PROVIDED WITHOUT WARRANTY OF ANY KIND. SENSOPIA DISCLAIMS ANY WARRANTY INCLUDING, WITHOUT LIMITATION, SATISFACTORY QUALITY OR ACCURACY OF DIMENSIONS.

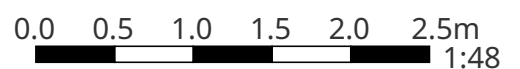

# 22/19 Schuffenhauer Street

## Bedroom

Width: 3.44 m  
Length: 3.57 m  
Area: 12.28 m<sup>2</sup>  
Perimeter: 14.02 m

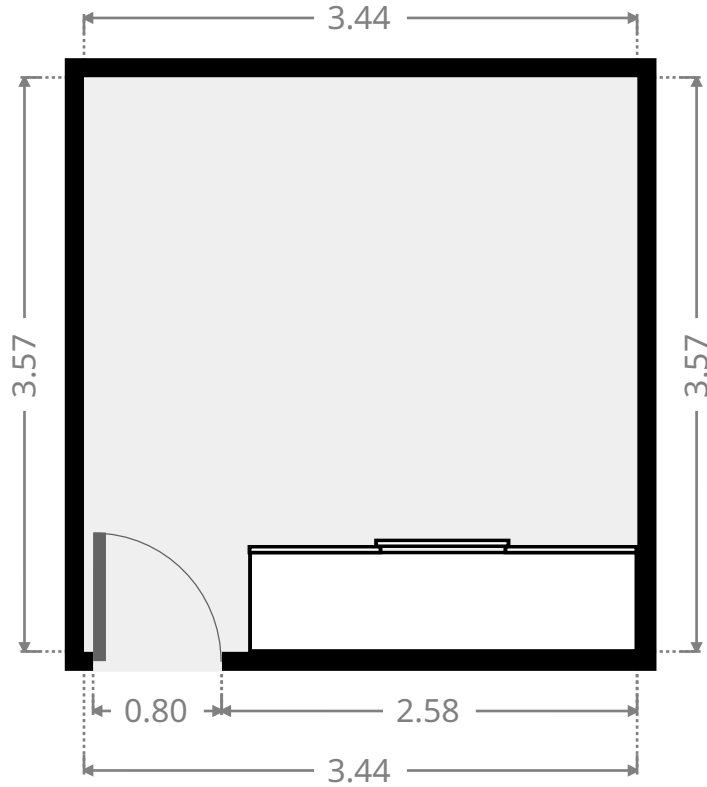
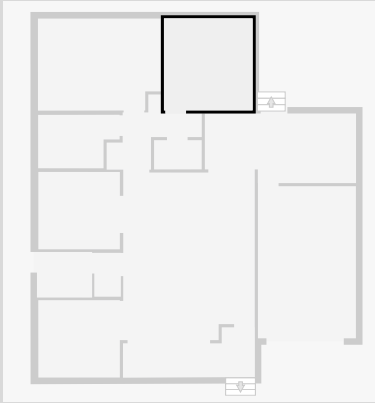

## Toilet / Half Bath

Width: 1.14 m  
Length: 1.85 m  
Area: 2.09 m<sup>2</sup>  
Perimeter: 5.96 m

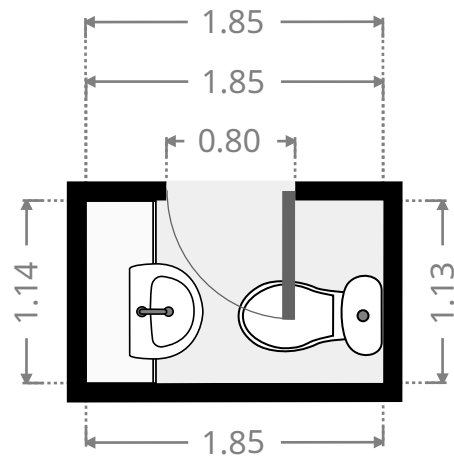
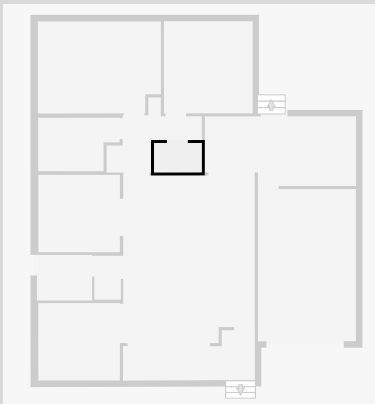

# 22/19 Schuffenhauer Street

## Other

Width: 2.70 m  
 Length: 5.87 m  
 Area: 14.75 m<sup>2</sup>  
 Perimeter: 17.13 m

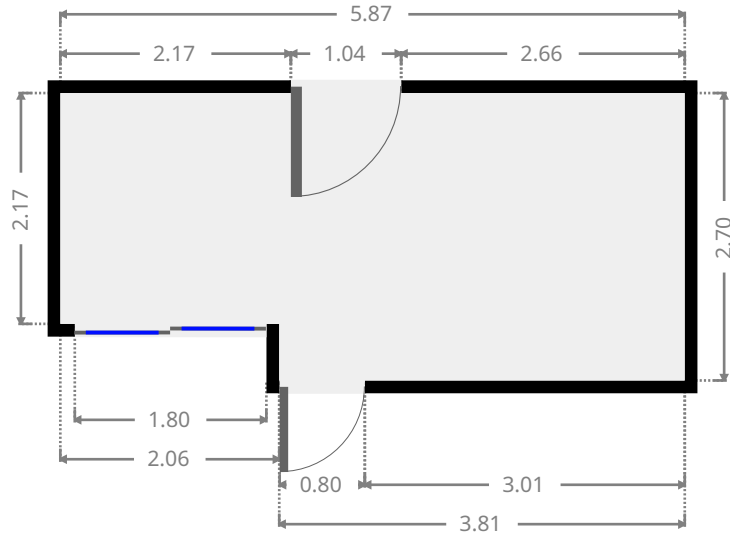
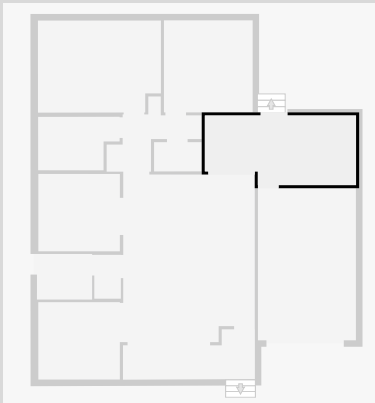

## Garage

Width: 3.80 m  
 Length: 5.90 m  
 Area: 22.42 m<sup>2</sup>  
 Perimeter: 19.40 m

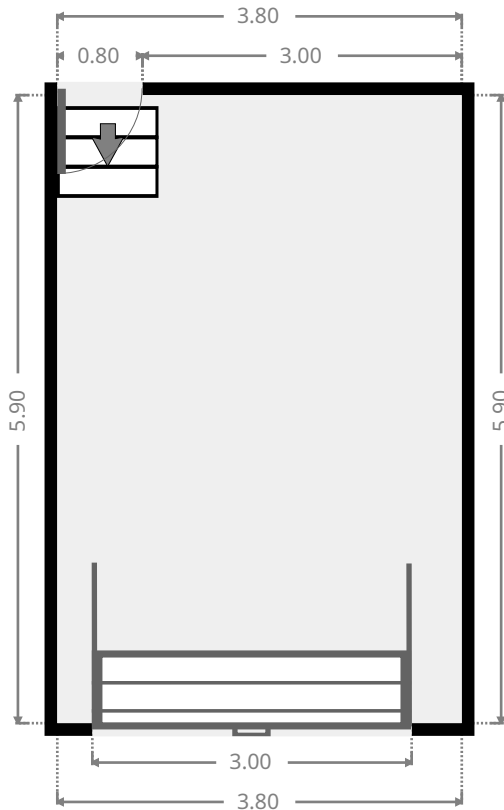
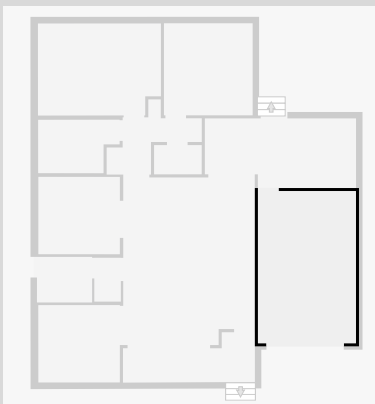

THIS FLOORPLAN IS PROVIDED WITHOUT WARRANTY OF ANY KIND. SENSOPIA DISCLAIMS ANY WARRANTY INCLUDING, WITHOUT LIMITATION, SATISFACTORY QUALITY OR ACCURACY OF DIMENSIONS.



# 22/19 Schuffenhauer Street

## Other

Width: 1.93 m  
Length: 5.13 m  
Area: 7.55 m<sup>2</sup>  
Perimeter: 14.11 m

