

# 214 Kerrigan Street

Created on  
2020-08-13

Floors  
1

▼ Ground Floor



THIS FLOORPLAN IS PROVIDED WITHOUT WARRANTY OF ANY KIND. SENSOPIA DISCLAIMS ANY WARRANTY INCLUDING, WITHOUT LIMITATION, SATISFACTORY QUALITY OR ACCURACY OF DIMENSIONS.

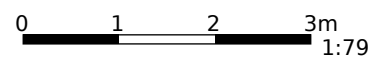

FLOORS: 1

▼ **Living Room**  
Ground Floor

WIDTH: 3.64 m • LENGTH: 5.33 m  
AREA: 19.37 m<sup>2</sup> • PERIMETER: 17.93 m

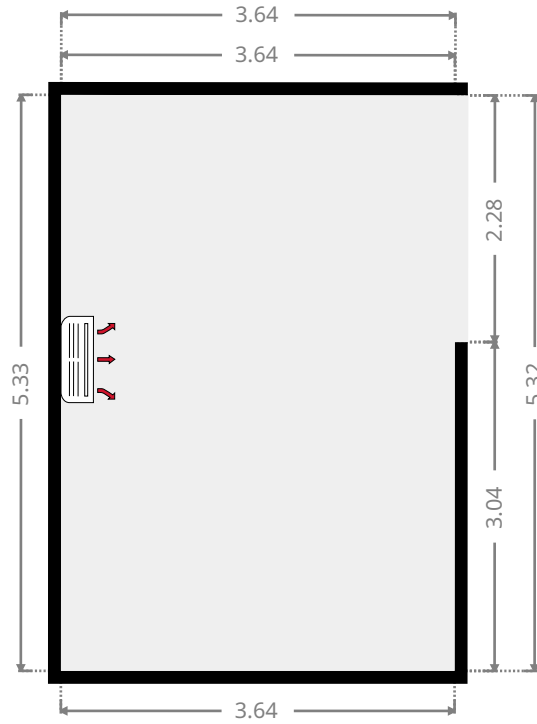
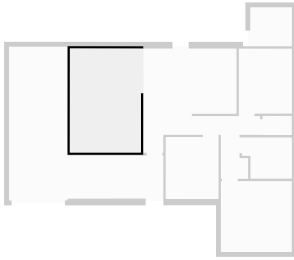

▼ **Kitchen**  
Ground Floor

WIDTH: 4.78 m • LENGTH: 3.34 m  
AREA: 15.97 m<sup>2</sup> • PERIMETER: 16.24 m

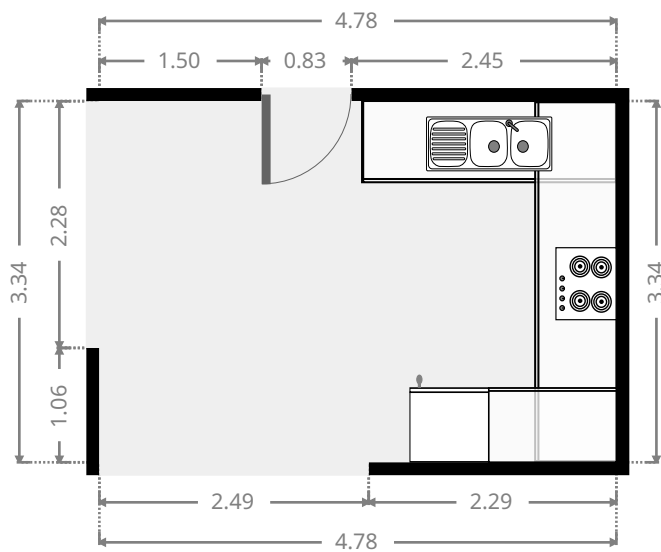
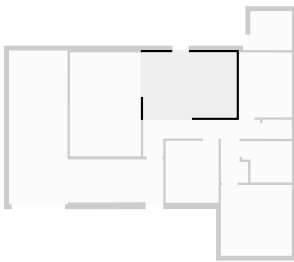

THIS FLOORPLAN IS PROVIDED WITHOUT WARRANTY OF ANY KIND. SENSOPIA DISCLAIMS ANY WARRANTY INCLUDING, WITHOUT LIMITATION, SATISFACTORY QUALITY OR ACCURACY OF DIMENSIONS.

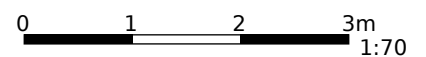

FLOORS: 1

▼ **Hall**  
Ground Floor

**WIDTH:** 5.99 m • **LENGTH:** 1.88 m  
**AREA:** 6.70 m<sup>2</sup> • **PERIMETER:** 15.74 m

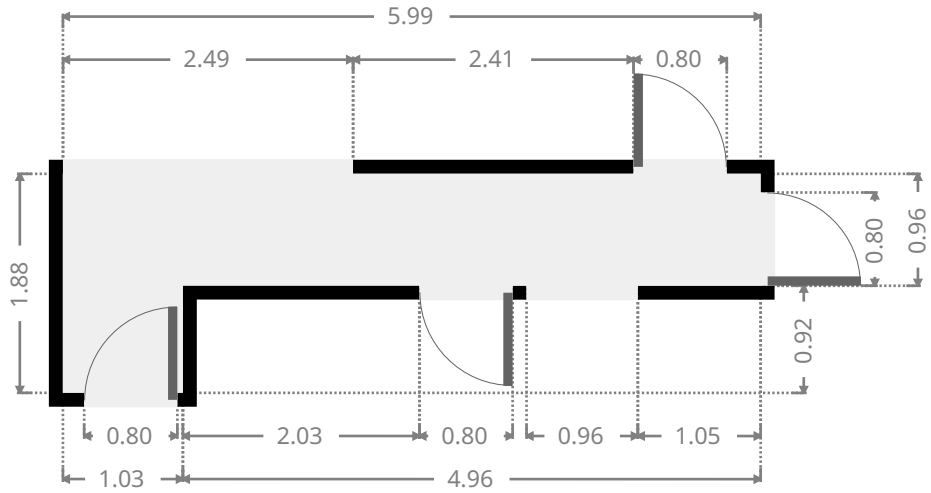
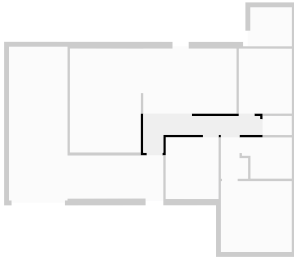

▼ **Bedroom**  
Ground Floor

**WIDTH:** 2.71 m • **LENGTH:** 3.18 m  
**AREA:** 8.62 m<sup>2</sup> • **PERIMETER:** 11.78 m

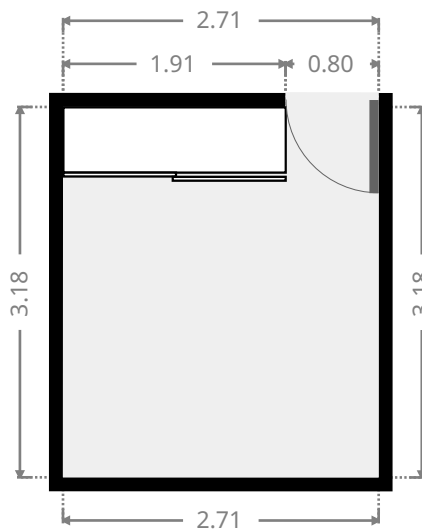
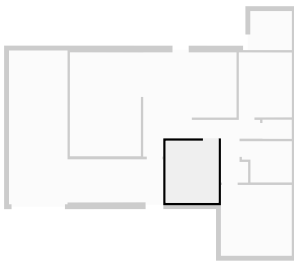

▼ **Hall**  
Ground Floor

WIDTH: 1.40 m • LENGTH: 2.13 m  
AREA: 2.50 m<sup>2</sup> • PERIMETER: 7.05 m

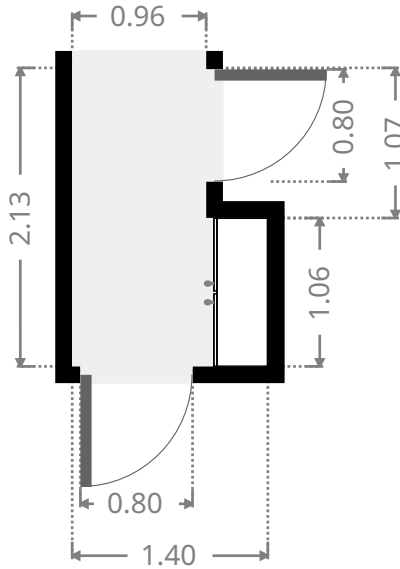
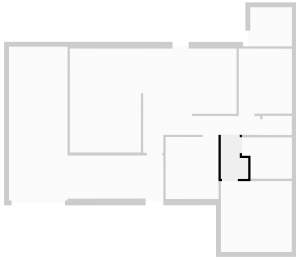

▼ **Master Bedroom**  
Ground Floor

WIDTH: 3.63 m • LENGTH: 3.63 m  
AREA: 13.18 m<sup>2</sup> • PERIMETER: 14.52 m

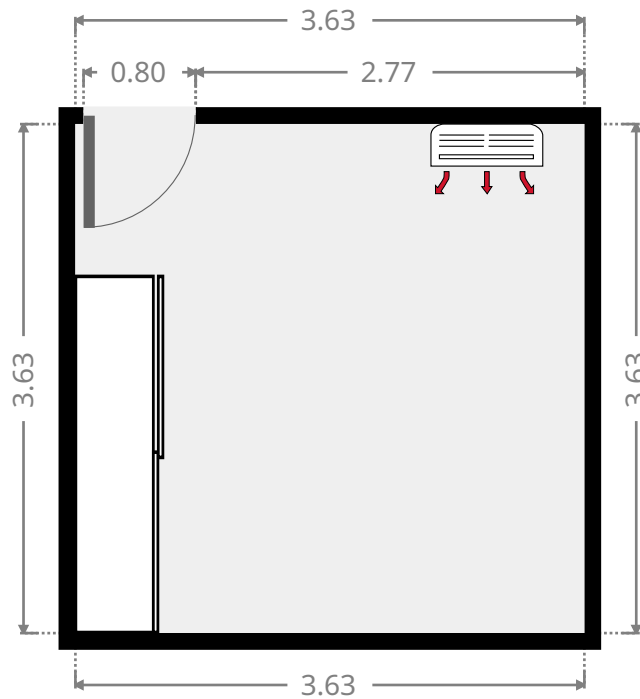
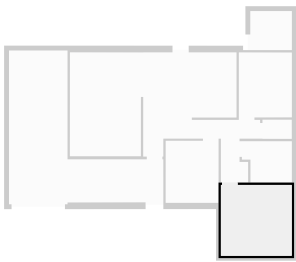

FLOORS: 1

▼ **Bathroom**  
Ground Floor

WIDTH: 2.56 m • LENGTH: 2.11 m  
AREA: 4.89 m<sup>2</sup> • PERIMETER: 9.34 m

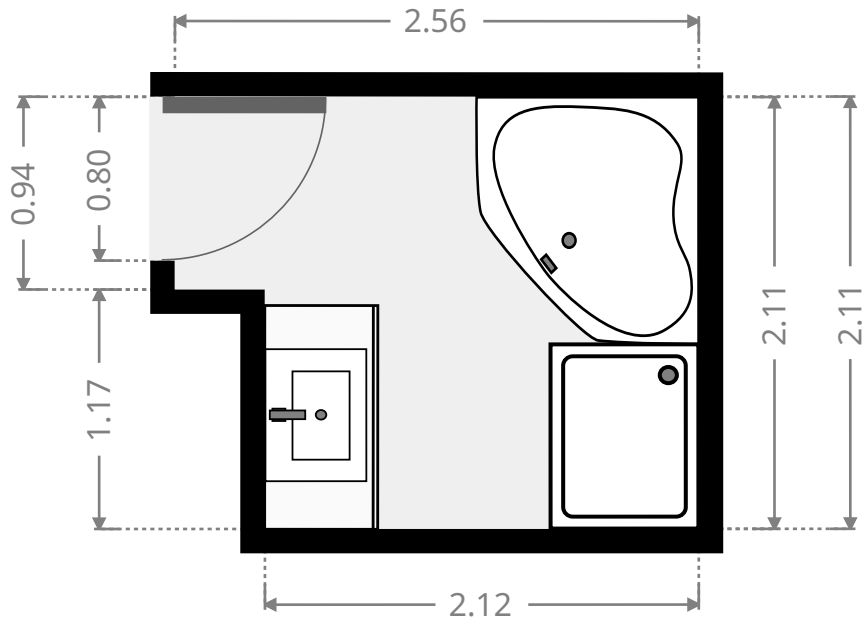
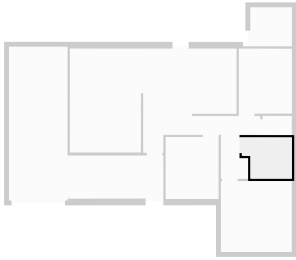

▼ **Toilet**  
Ground Floor

WIDTH: 1.51 m • LENGTH: 0.98 m  
AREA: 1.47 m<sup>2</sup> • PERIMETER: 4.97 m

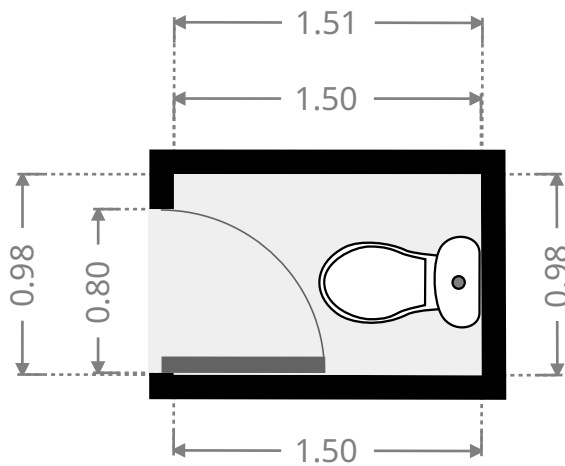
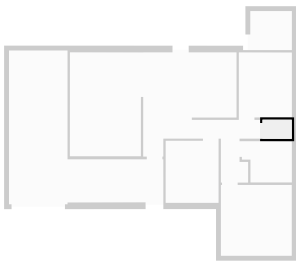

FLOORS: 1

▼ **Bedroom**  
Ground Floor

WIDTH: 2.72 m • LENGTH: 3.34 m  
AREA: 9.05 m<sup>2</sup> • PERIMETER: 12.09 m

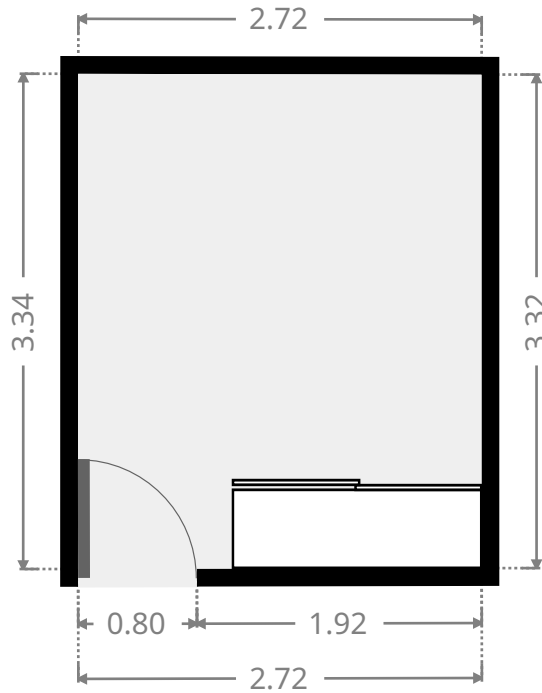
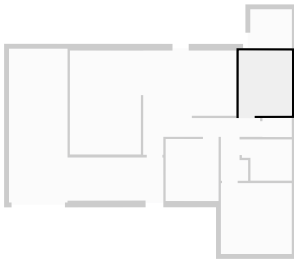

▼ **Other**  
Ground Floor

WIDTH: 4.79 m • LENGTH: 2.21 m  
AREA: 10.56 m<sup>2</sup> • PERIMETER: 13.99 m

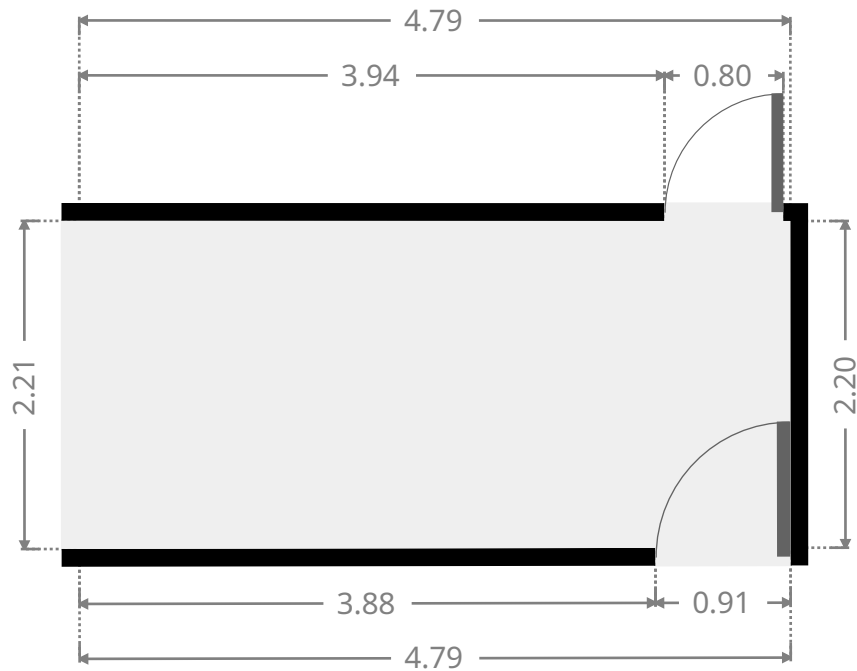
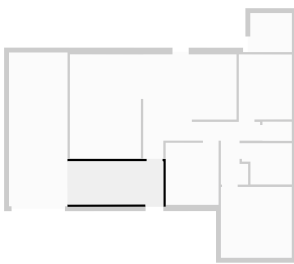

▼ **Garage**  
Ground Floor

**WIDTH:** 3.00 m • **LENGTH:** 7.88 m  
**AREA:** 23.64 m<sup>2</sup> • **PERIMETER:** 21.76 m

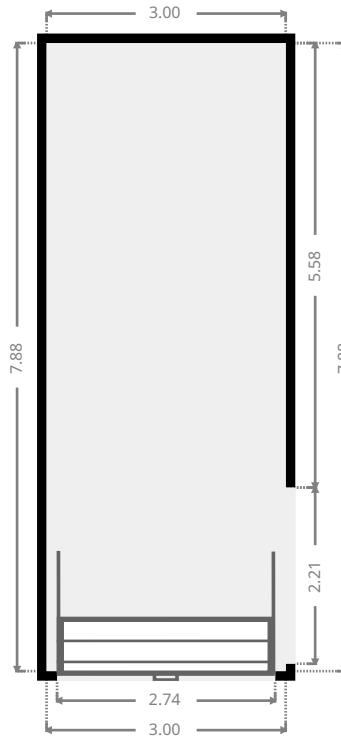
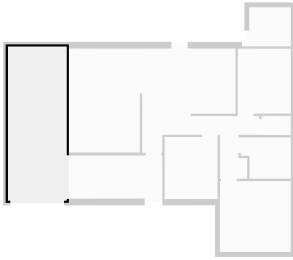

▼ **Laundry Room**  
Ground Floor

**WIDTH:** 2.13 m • **LENGTH:** 2.00 m  
**AREA:** 4.26 m<sup>2</sup> • **PERIMETER:** 8.26 m

