

21 Old Rollo Drive

Created on
2021-07-29

Floors
1



▼ Ground Floor

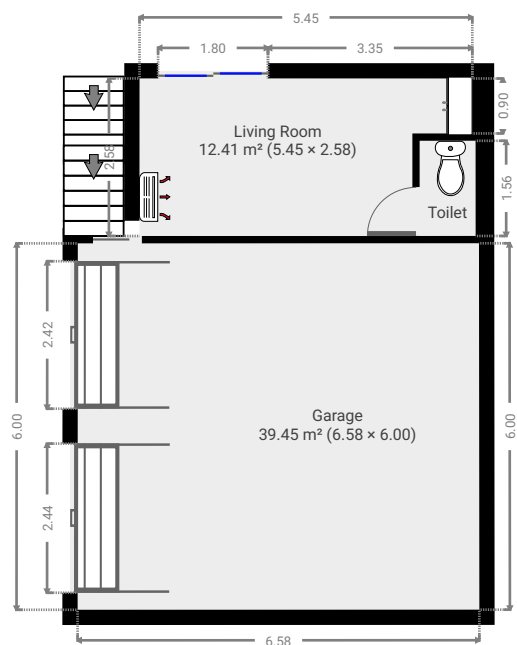

▼ Laundry Room
Ground Floor

WIDTH: 3.03 m • LENGTH: 3.13 m
AREA: 9.49 m² • PERIMETER: 12.32 m

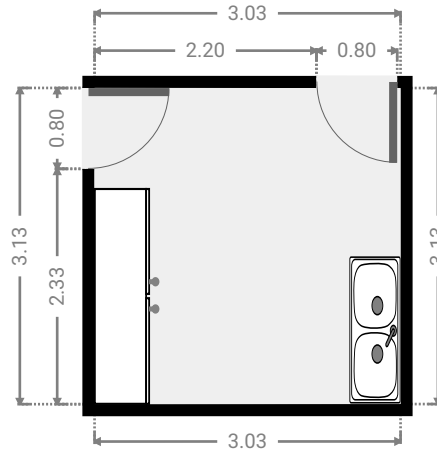
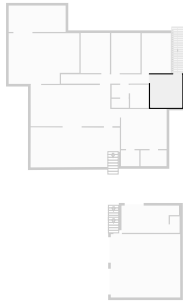

▼ Garage
Ground Floor

WIDTH: 6.58 m • LENGTH: 6.00 m
AREA: 39.45 m² • PERIMETER: 25.15 m

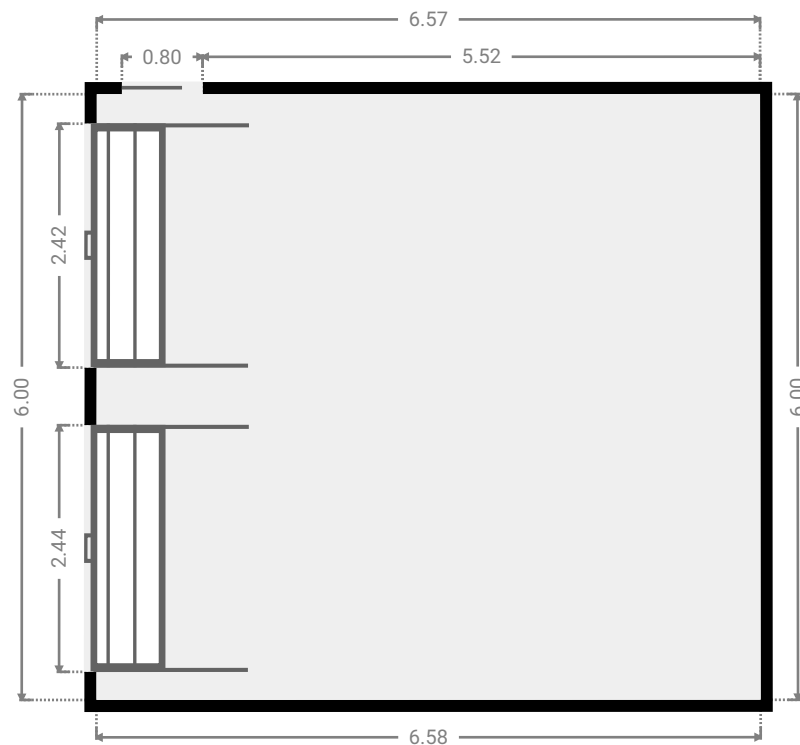
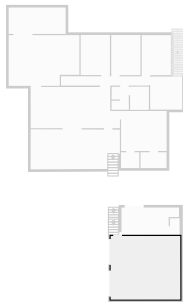

▼ **Toilet**
Ground Floor

WIDTH: 0.92 m • LENGTH: 1.56 m
AREA: 1.43 m² • PERIMETER: 4.95 m

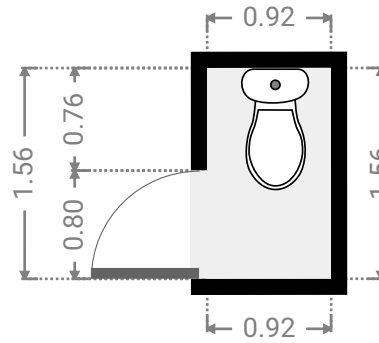
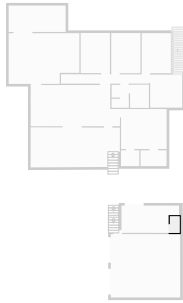

▼ **Living Room**
Ground Floor

WIDTH: 5.45 m • LENGTH: 2.58 m
AREA: 12.41 m² • PERIMETER: 16.06 m

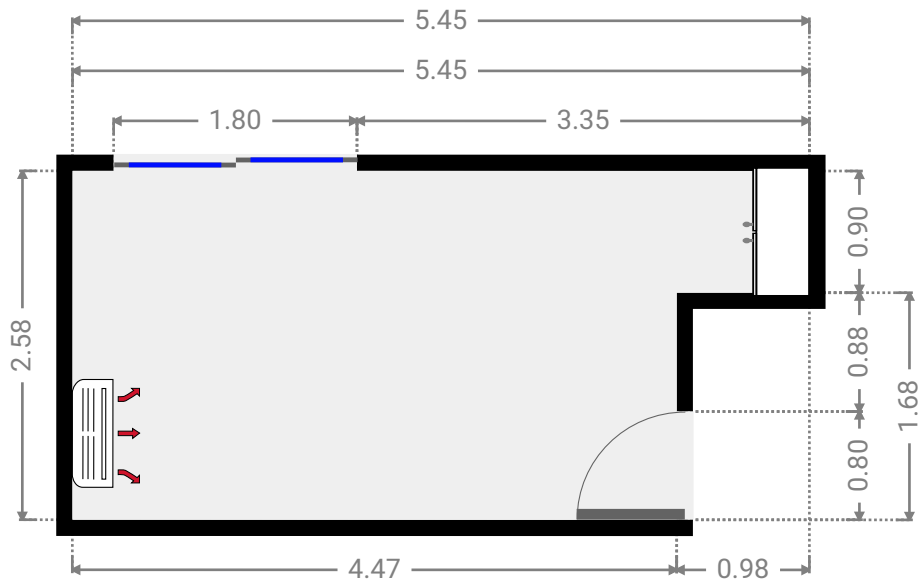
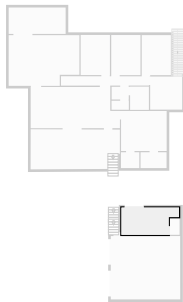

▼ Other
Ground Floor

WIDTH: 8.46 m • LENGTH: 3.80 m
AREA: 30.16 m² • PERIMETER: 24.43 m

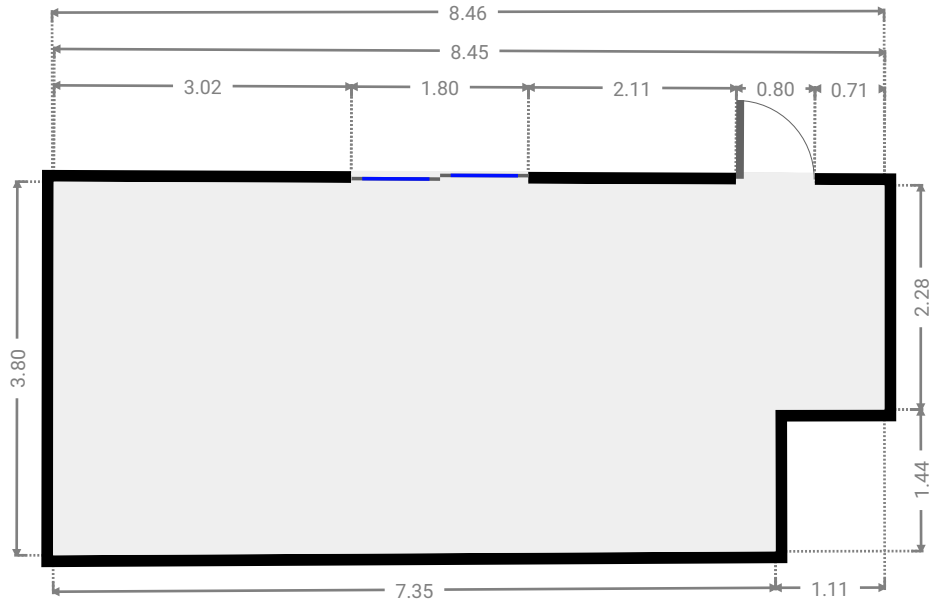
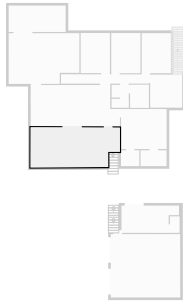

▼ Other
Ground Floor

WIDTH: 5.40 m • LENGTH: 2.50 m
AREA: 13.49 m² • PERIMETER: 15.79 m

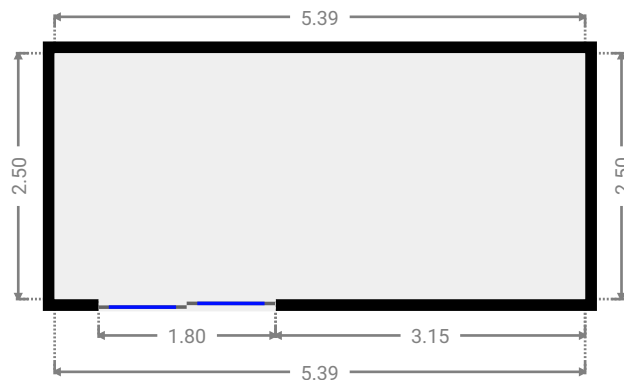

▼ Toilet
Ground Floor

WIDTH: 1.64 m • LENGTH: 0.86 m
AREA: 1.40 m² • PERIMETER: 4.98 m

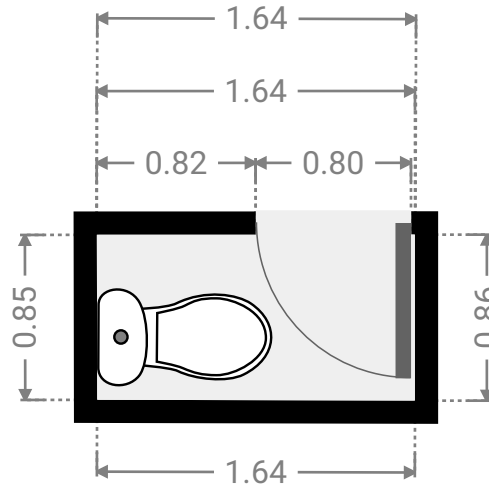
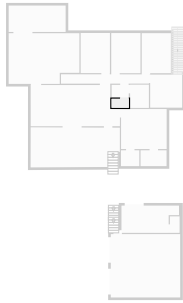

▼ Hall
Ground Floor

WIDTH: 1.62 m • LENGTH: 1.20 m
AREA: 1.94 m² • PERIMETER: 5.64 m

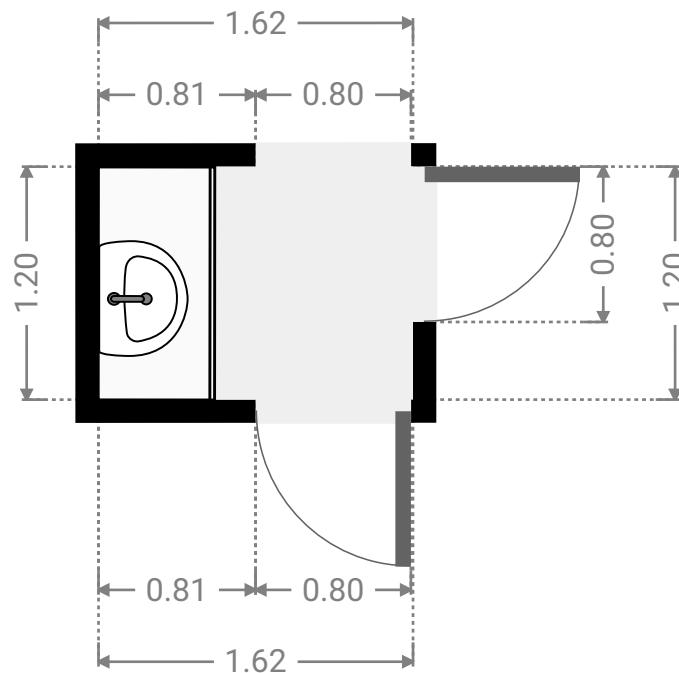

▼ Bathroom
Ground Floor

WIDTH: 1.78 m • LENGTH: 2.20 m
AREA: 3.92 m² • PERIMETER: 7.96 m

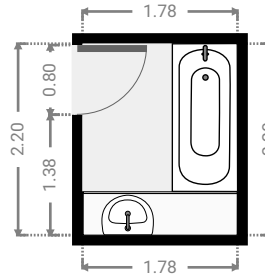
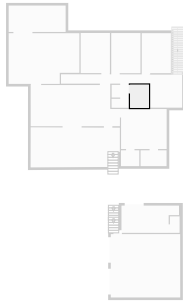

▼ Living Room
Ground Floor

WIDTH: 8.46 m • LENGTH: 3.91 m
AREA: 30.91 m² • PERIMETER: 24.71 m

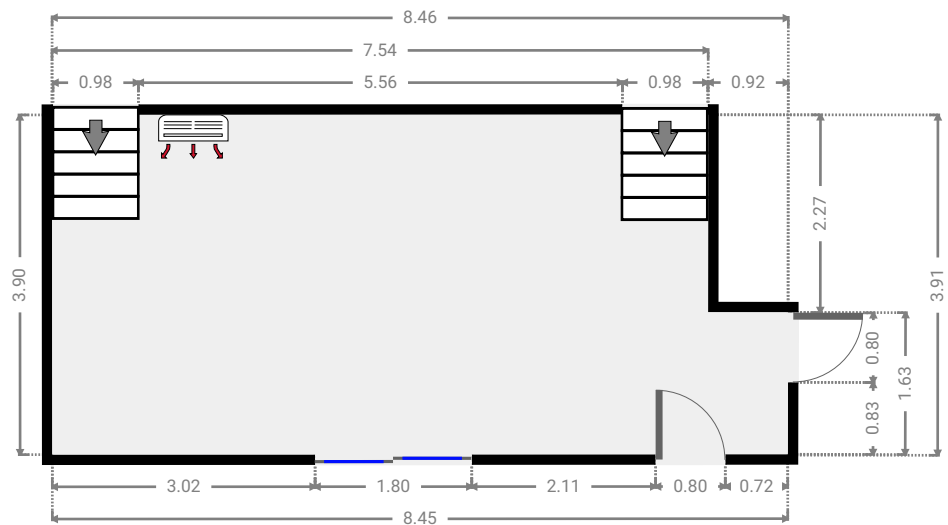

▼ **Bedroom**
Ground Floor

WIDTH: 2.76 m • LENGTH: 3.79 m
AREA: 10.46 m² • PERIMETER: 13.10 m

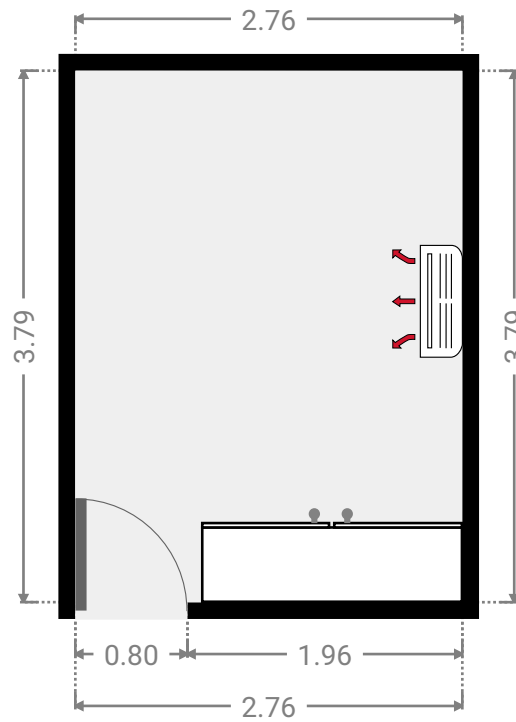

▼ **Bedroom**
Ground Floor

WIDTH: 2.77 m • LENGTH: 3.80 m
AREA: 10.53 m² • PERIMETER: 13.14 m

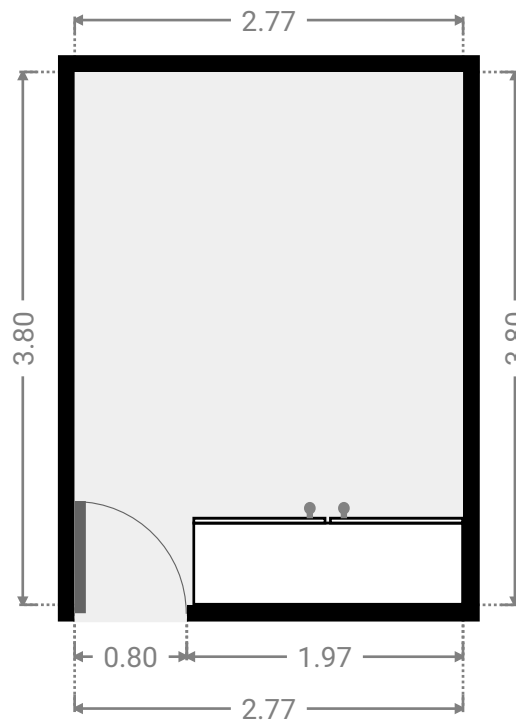

▼ **Bedroom**
Ground Floor

WIDTH: 2.77 m • LENGTH: 3.80 m
AREA: 10.53 m² • PERIMETER: 13.14 m

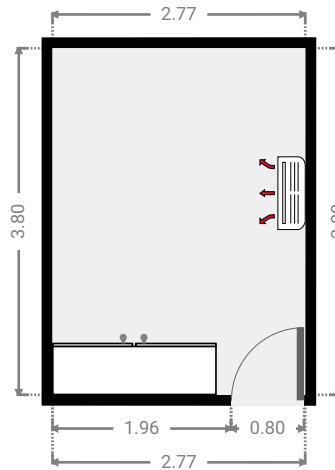

▼ **Hall**
Ground Floor

WIDTH: 8.33 m • LENGTH: 0.89 m
AREA: 7.32 m² • PERIMETER: 18.42 m

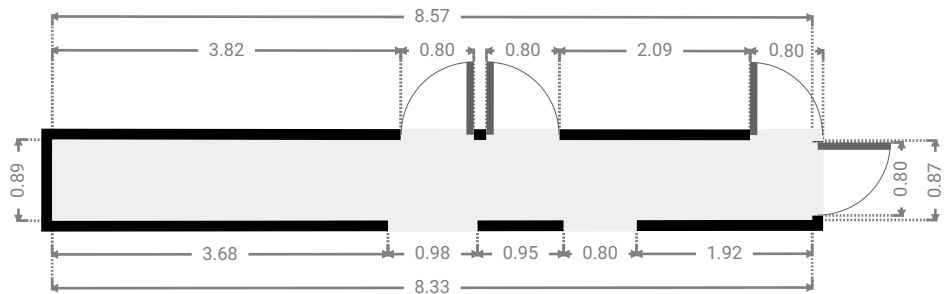
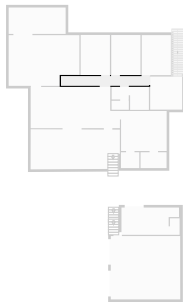

▼ Kitchen Ground Floor

WIDTH: 6.70 m • LENGTH: 4.80 m
AREA: 30.21 m² • PERIMETER: 23.00 m

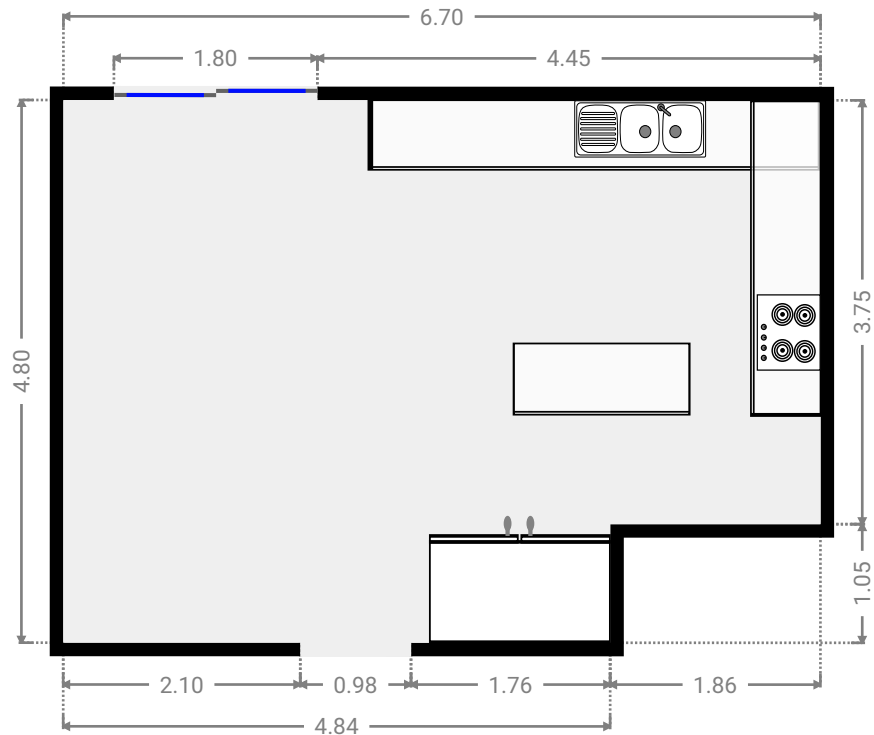
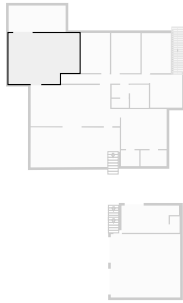

▼ Bathroom Ground Floor

WIDTH: 2.46 m • LENGTH: 1.50 m
AREA: 3.69 m² • PERIMETER: 7.92 m

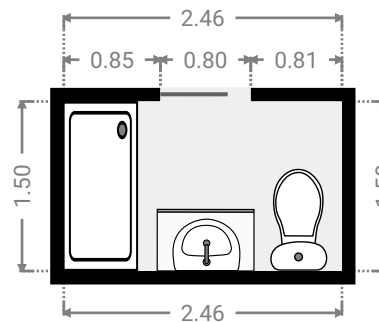
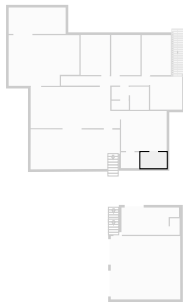

▼ **Closet**
Ground Floor

WIDTH: 1.74 m • LENGTH: 1.50 m
AREA: 2.61 m² • PERIMETER: 6.48 m

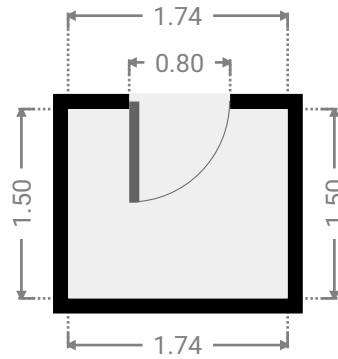
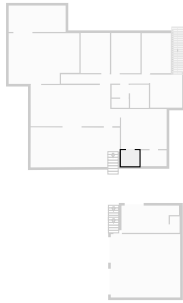

▼ **Master Bedroom**
Ground Floor

WIDTH: 4.32 m • LENGTH: 3.79 m
AREA: 16.37 m² • PERIMETER: 16.22 m

