

21 Annie Close

Ground Floor

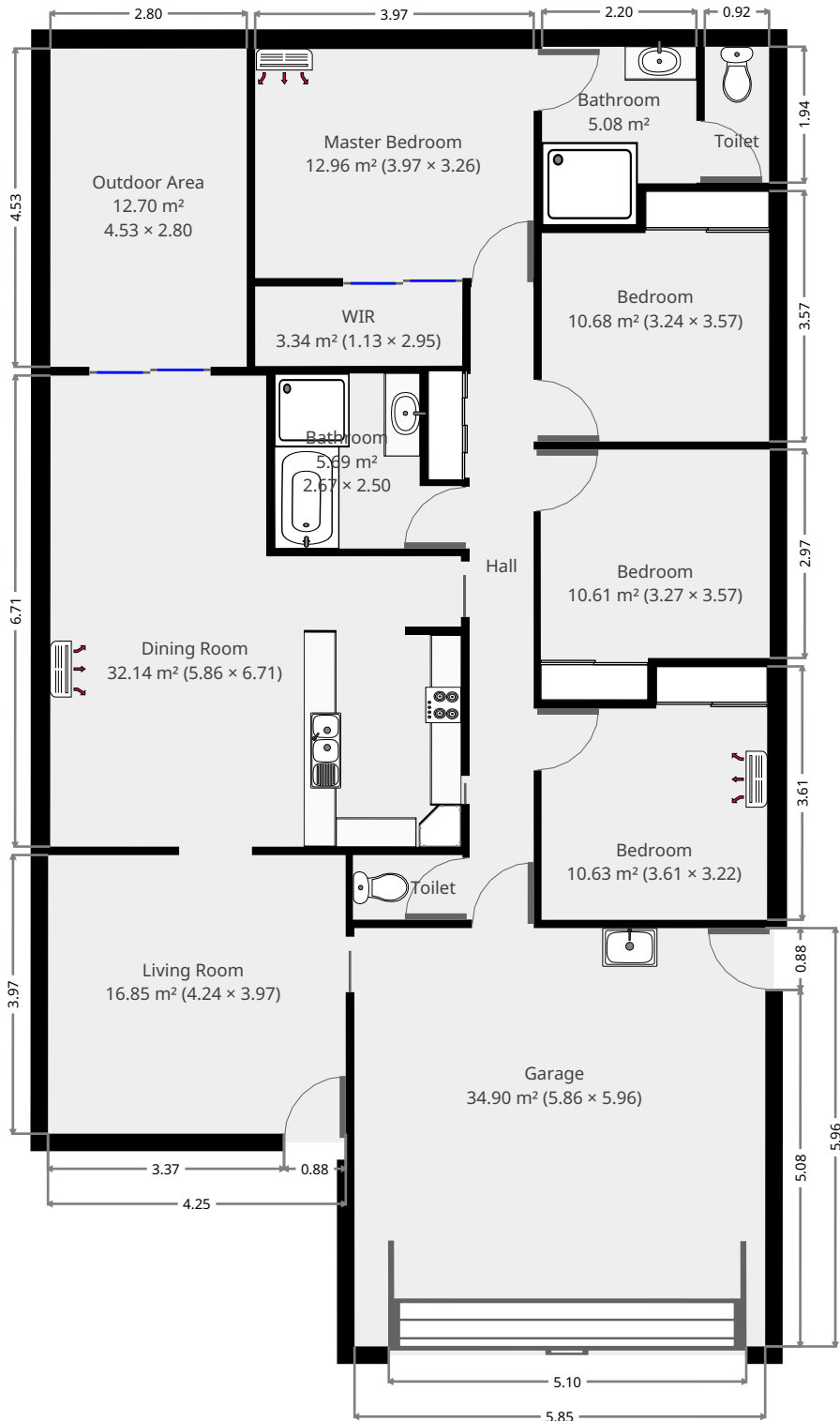

THIS FLOORPLAN IS PROVIDED WITHOUT WARRANTY OF ANY KIND. SENSOPIA DISCLAIMS ANY WARRANTY INCLUDING, WITHOUT LIMITATION, SATISFACTORY QUALITY OR ACCURACY OF DIMENSIONS.



21 Annie Close

Living Room

Width: 3.97 m
 Length: 4.24 m
 Area: 16.85 m²
 Perimeter: 16.43 m

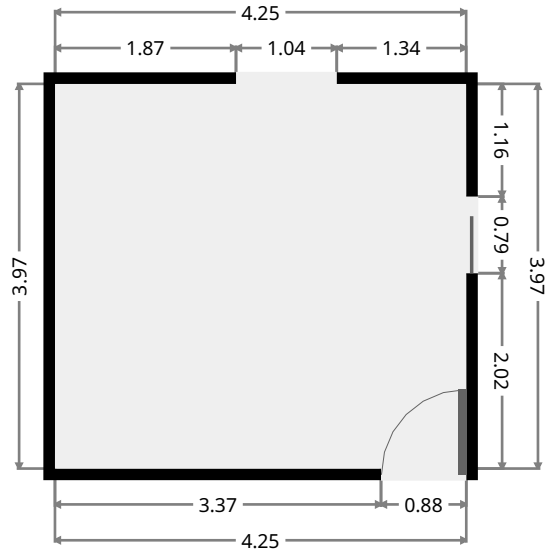
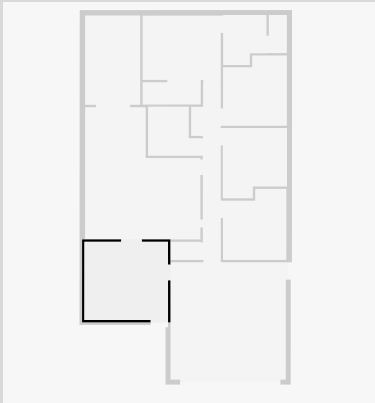

Dining Room

Width: 5.86 m
 Length: 6.71 m
 Area: 32.14 m²
 Perimeter: 25.13 m

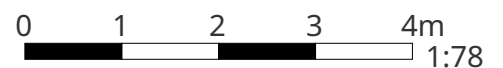
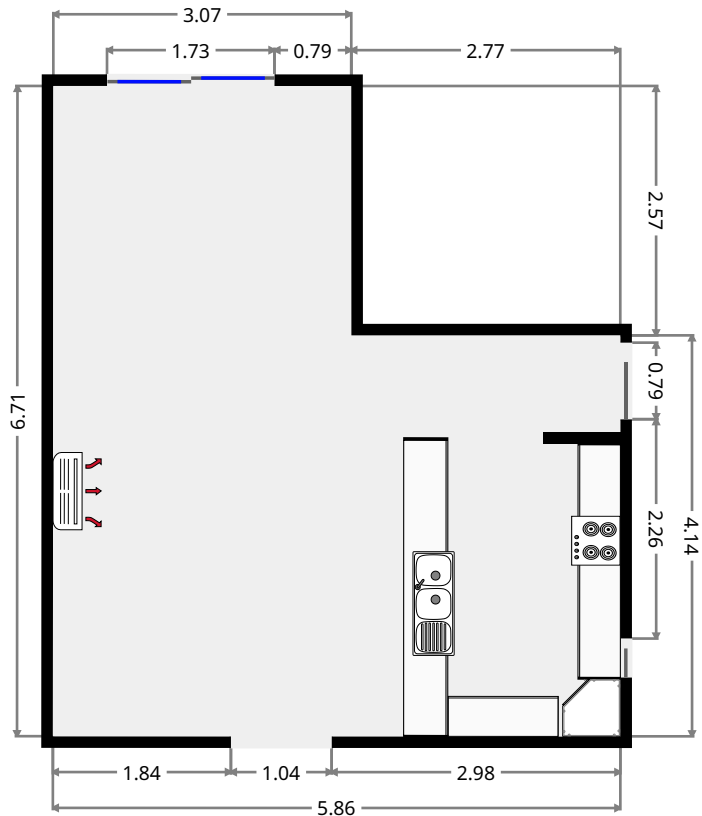
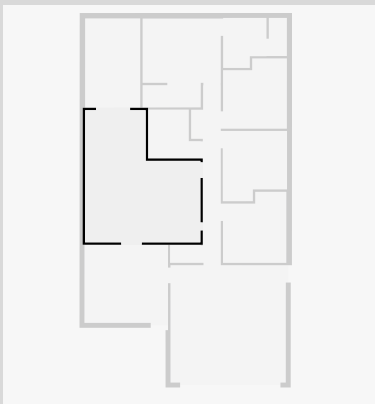

THIS FLOORPLAN IS PROVIDED WITHOUT WARRANTY OF ANY KIND. SENSOPIA DISCLAIMS ANY WARRANTY INCLUDING, WITHOUT LIMITATION, SATISFACTORY QUALITY OR ACCURACY OF DIMENSIONS.

21 Annie Close

Hall

Width: 1.50 m
 Length: 9.01 m
 Area: 9.08 m²
 Perimeter: 21.03 m

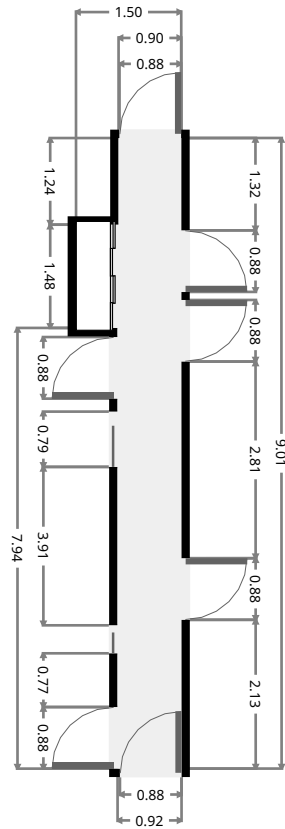
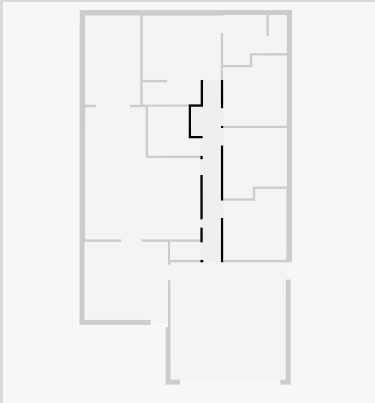

Toilet

Width: 0.92 m
 Length: 1.56 m
 Area: 1.44 m²
 Perimeter: 4.96 m

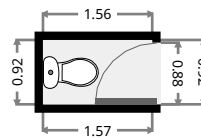
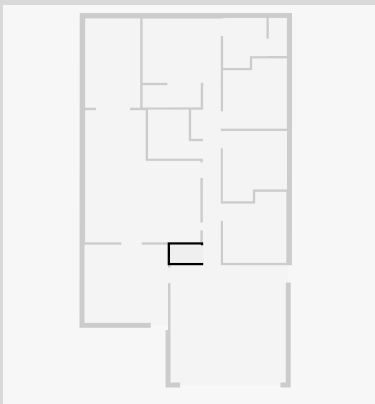

21 Annie Close

Garage

Width: 5.86 m
 Length: 5.96 m
 Area: 34.90 m²
 Perimeter: 23.63 m

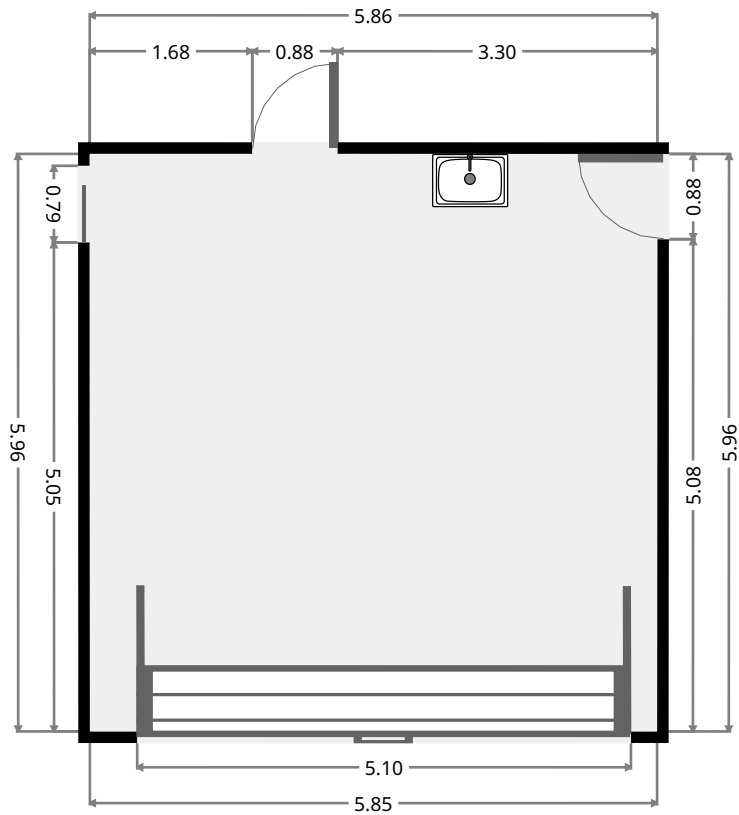
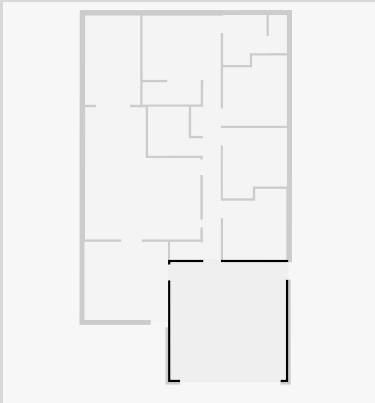

Bedroom

Width: 3.22 m
 Length: 3.61 m
 Area: 10.63 m²
 Perimeter: 13.65 m

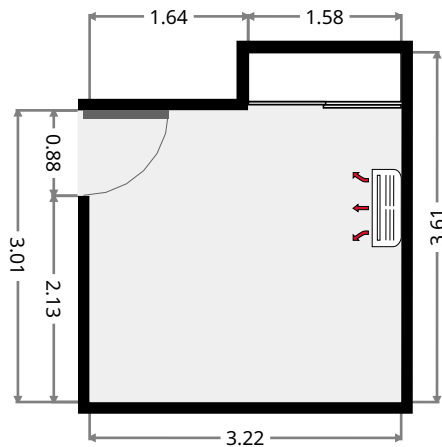
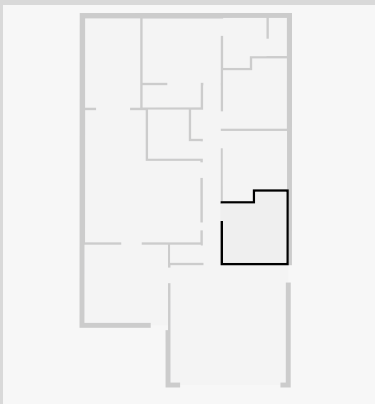

THIS FLOORPLAN IS PROVIDED WITHOUT WARRANTY OF ANY KIND. SENSOPIA DISCLAIMS ANY WARRANTY INCLUDING, WITHOUT LIMITATION, SATISFACTORY QUALITY OR ACCURACY OF DIMENSIONS.



21 Annie Close

Bathroom

Width: 2.50 m
 Length: 2.67 m
 Area: 5.69 m²
 Perimeter: 10.32 m

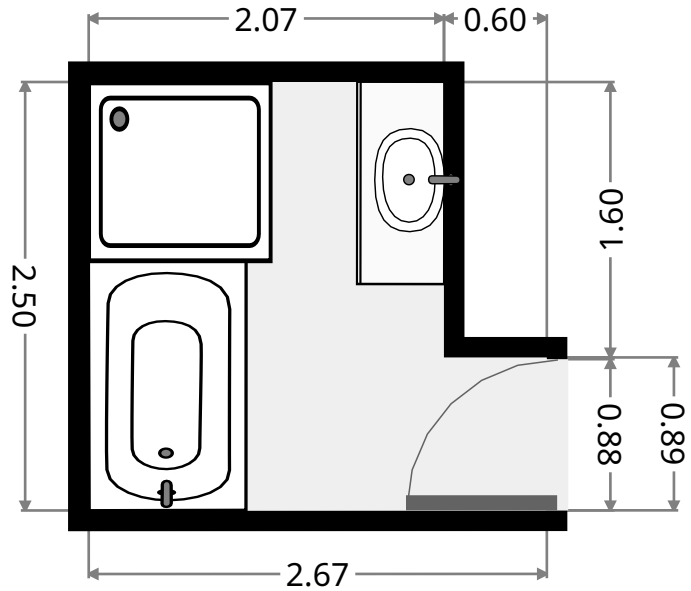
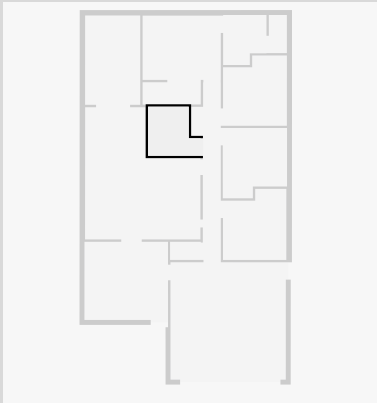

Bedroom

Width: 3.27 m
 Length: 3.57 m
 Area: 10.61 m²
 Perimeter: 13.67 m

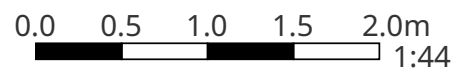
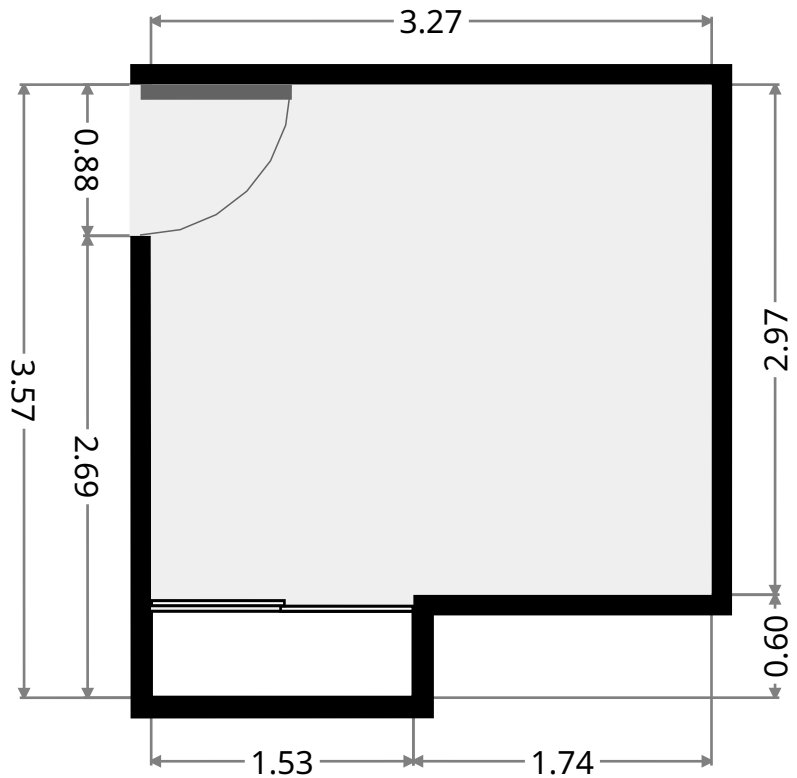
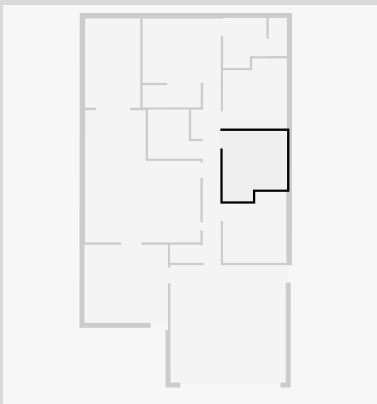

THIS FLOORPLAN IS PROVIDED WITHOUT WARRANTY OF ANY KIND. SENSOPIA DISCLAIMS ANY WARRANTY INCLUDING, WITHOUT LIMITATION, SATISFACTORY QUALITY OR ACCURACY OF DIMENSIONS.

21 Annie Close

Bedroom

Width: 3.24 m
 Length: 3.57 m
 Area: 10.68 m²
 Perimeter: 13.62 m

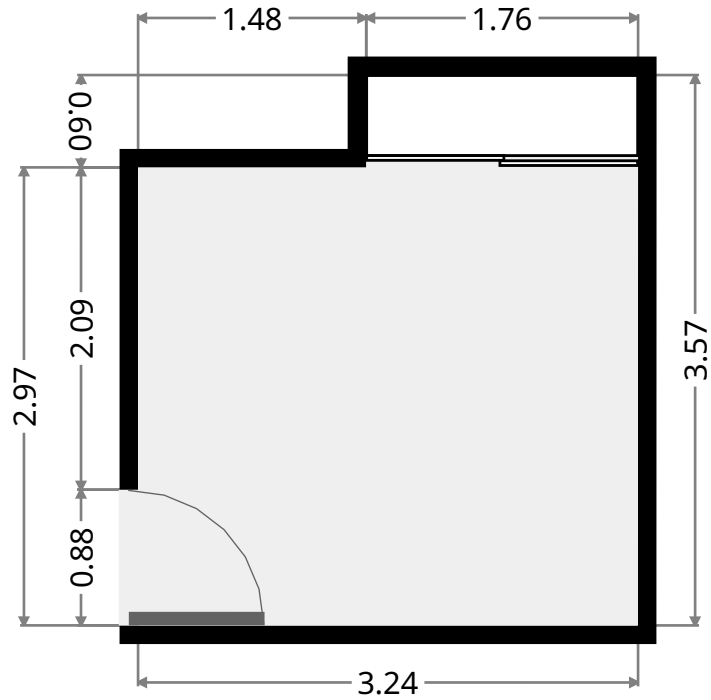
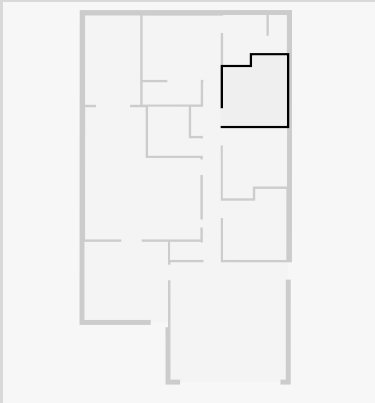

Master Bedroom

Width: 3.26 m
 Length: 3.97 m
 Area: 12.96 m²
 Perimeter: 14.47 m

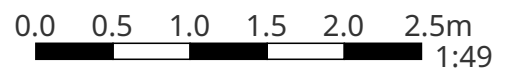
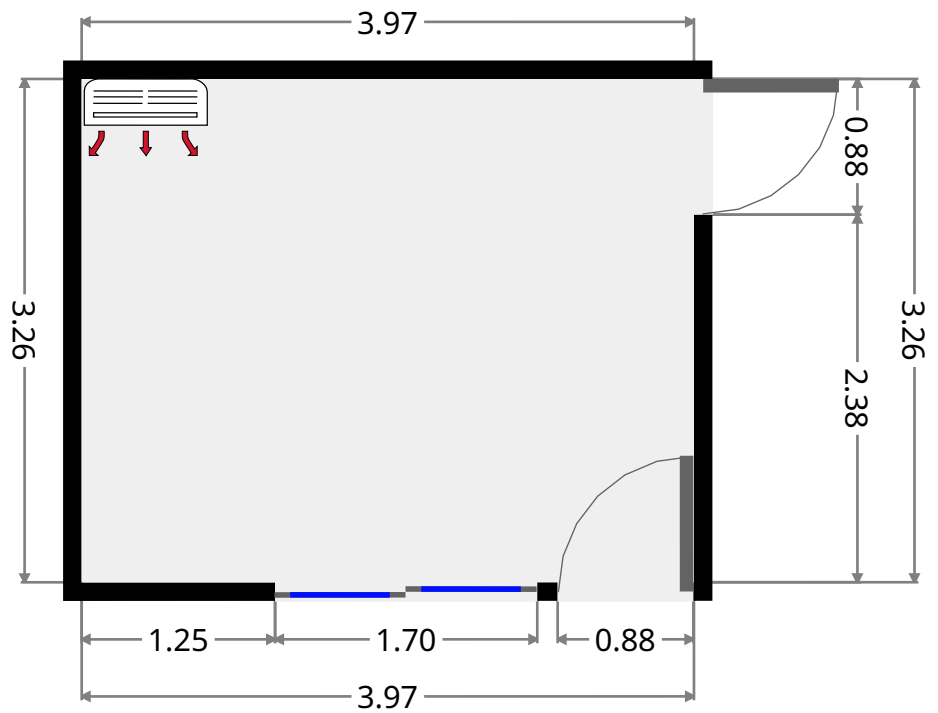
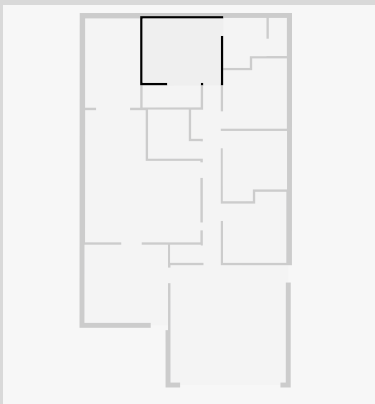

THIS FLOORPLAN IS PROVIDED WITHOUT WARRANTY OF ANY KIND. SENSOPIA DISCLAIMS ANY WARRANTY INCLUDING, WITHOUT LIMITATION, SATISFACTORY QUALITY OR ACCURACY OF DIMENSIONS.

21 Annie Close

Bathroom

Width: 2.20 m
 Length: 2.54 m
 Area: 5.08 m²
 Perimeter: 9.48 m

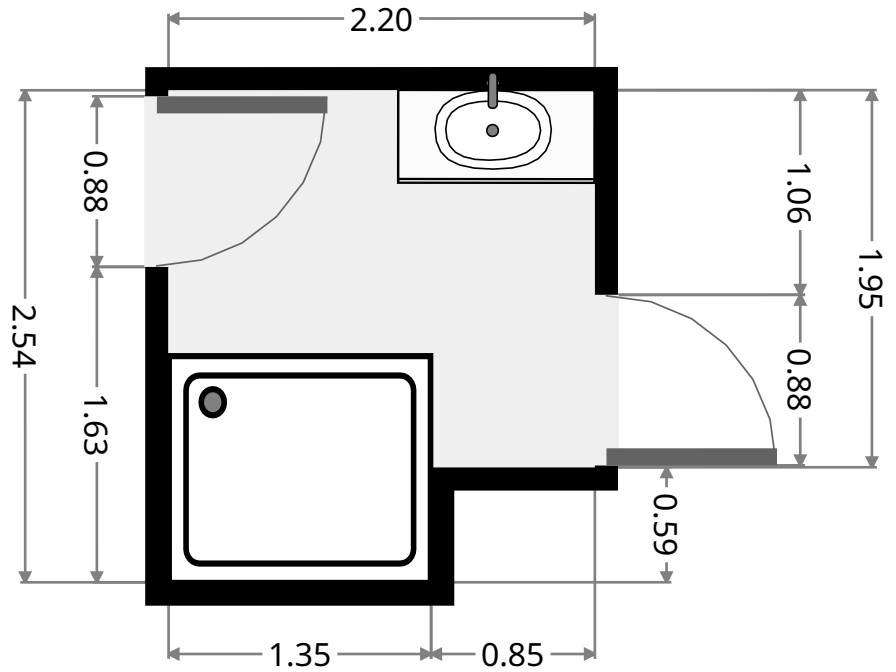
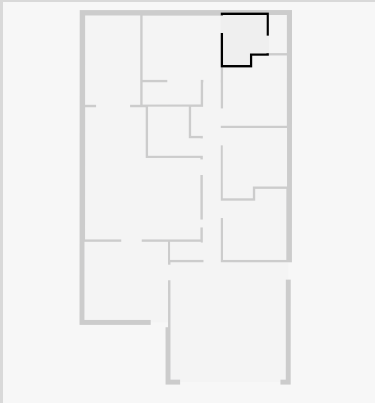

Toilet

Width: 0.92 m
 Length: 1.94 m
 Area: 1.77 m²
 Perimeter: 5.70 m

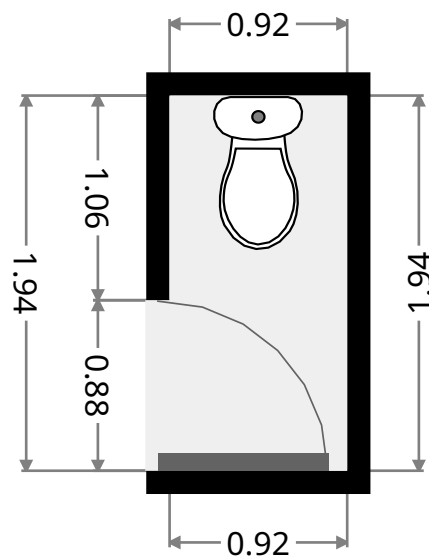
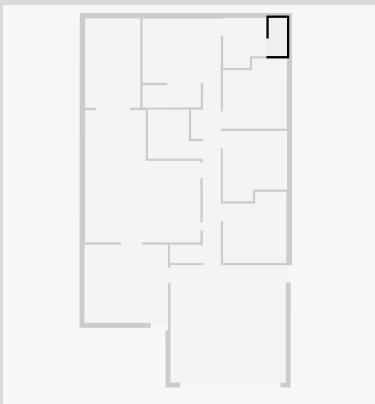

21 Annie Close

WIR

Width: 1.13 m
Length: 2.95 m
Area: 3.34 m²
Perimeter: 8.17 m

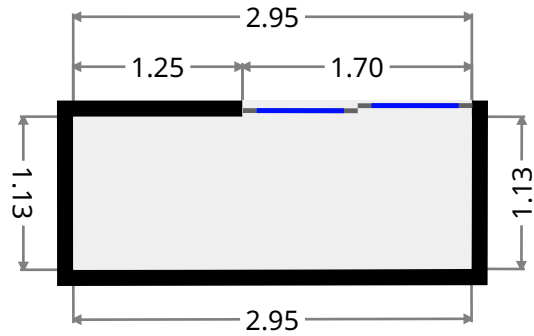
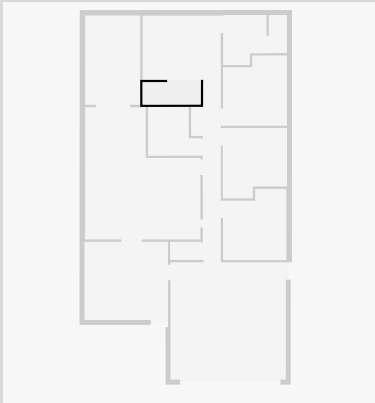

Outdoor Area

Width: 2.80 m
Length: 4.53 m
Area: 12.70 m²
Perimeter: 14.67 m

