

# 21/58 Lillypilly Resort

Created on  
2021-05-20

Floors  
2

## ▼ Ground Floor

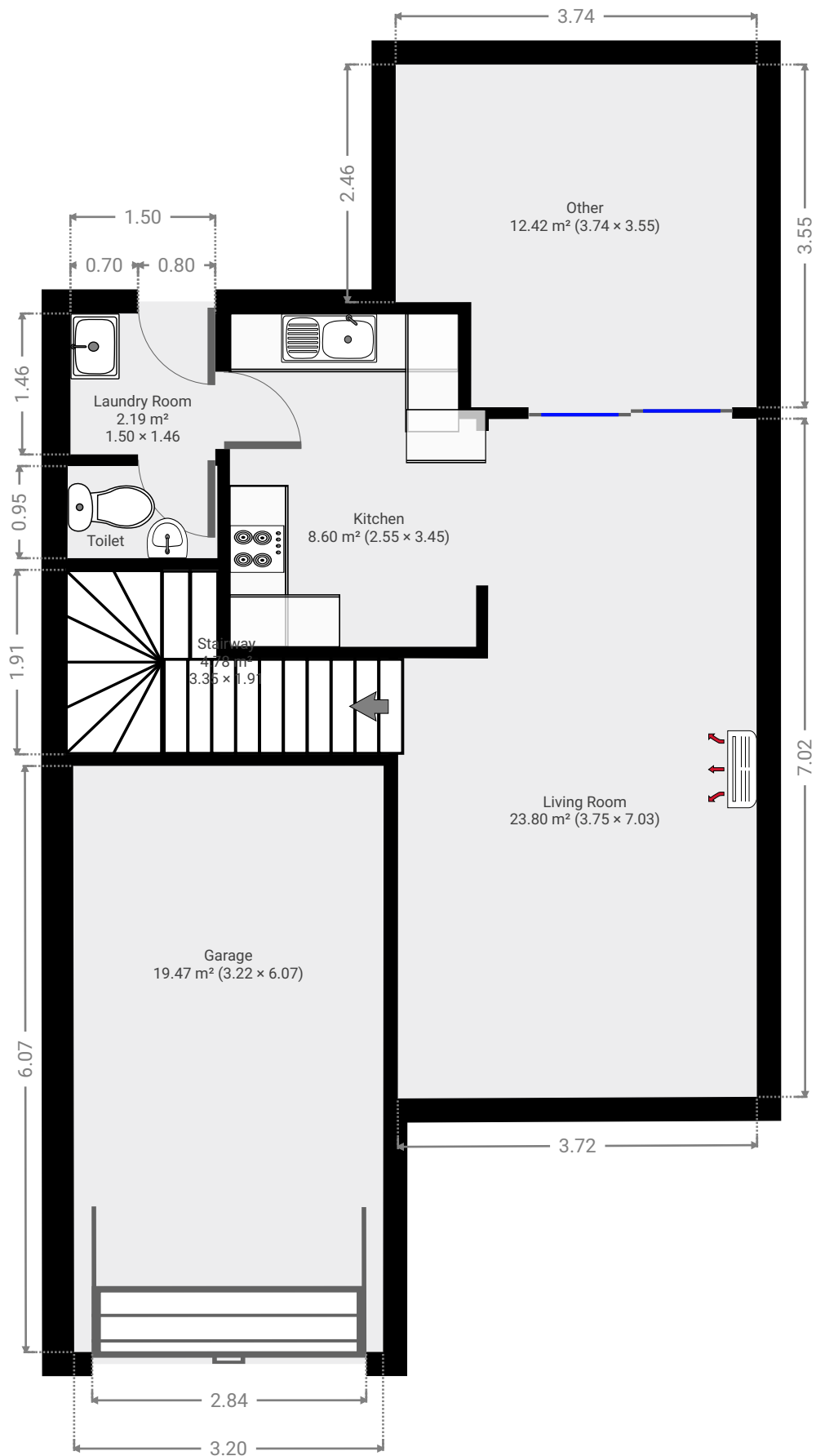

## ▼ Living Room Ground Floor

WIDTH: 3.75 m • LENGTH: 7.03 m  
AREA: 23.80 m<sup>2</sup> • PERIMETER: 21.49 m

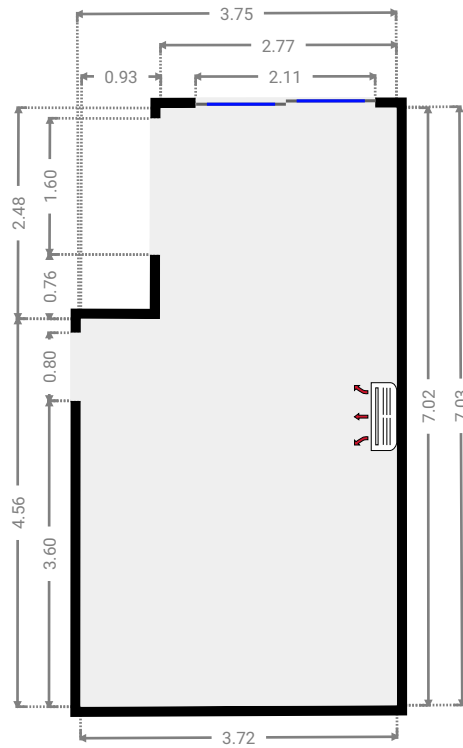
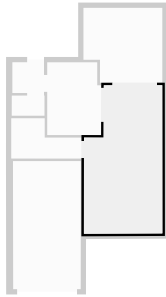

## ▼ Kitchen Ground Floor

WIDTH: 2.55 m • LENGTH: 3.45 m  
AREA: 8.60 m<sup>2</sup> • PERIMETER: 12.00 m

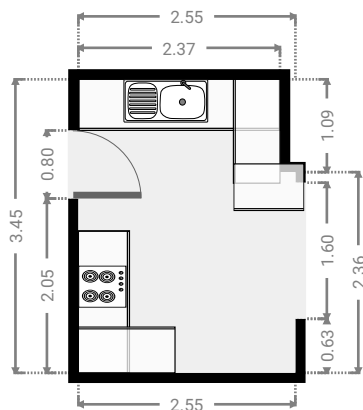
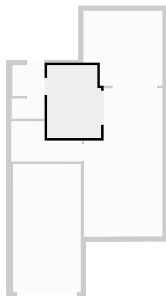

## ▼ Garage Ground Floor

WIDTH: 3.22 m • LENGTH: 6.07 m  
AREA: 19.47 m<sup>2</sup> • PERIMETER: 18.56 m

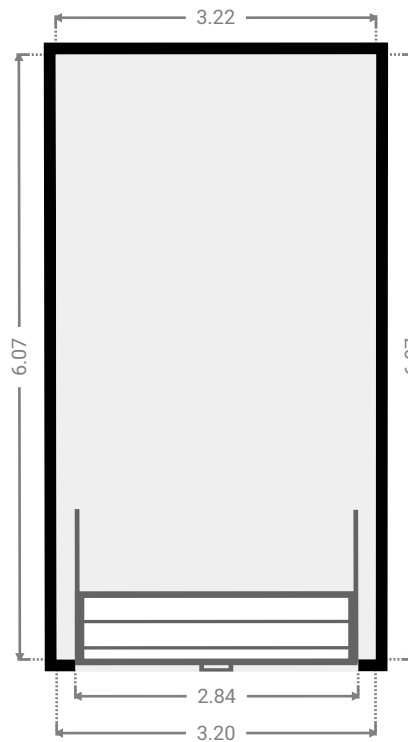
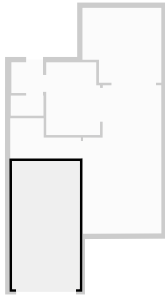

## ▼ Stairway Ground Floor

WIDTH: 3.35 m • LENGTH: 1.91 m  
AREA: 4.78 m<sup>2</sup> • PERIMETER: 10.52 m

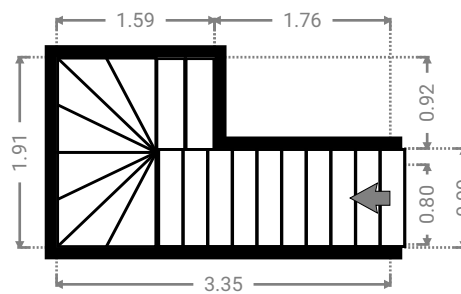
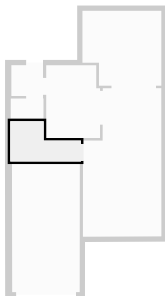

▼ Other  
Ground Floor

WIDTH: 3.74 m • LENGTH: 3.55 m  
AREA: 12.42 m<sup>2</sup> • PERIMETER: 14.58 m

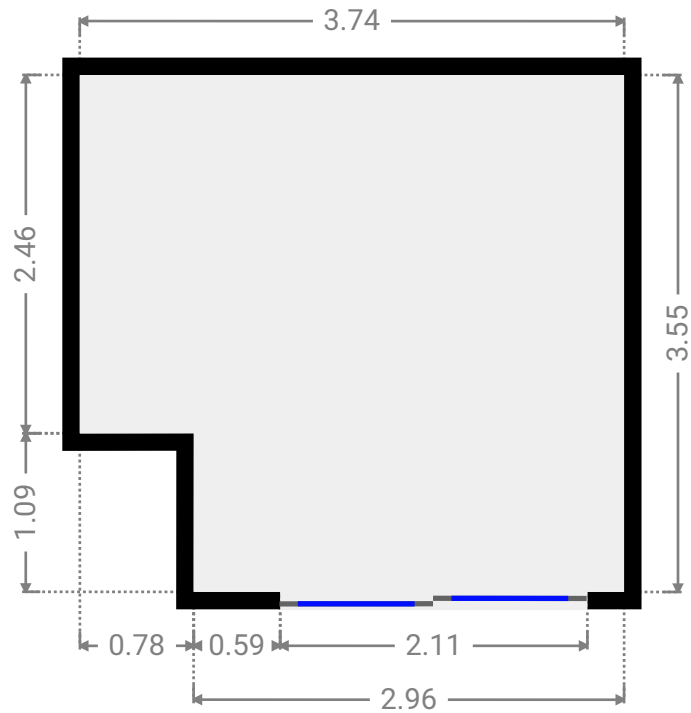
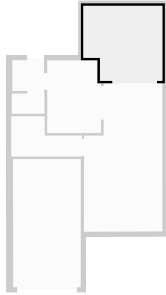

▼ Laundry Room  
Ground Floor

WIDTH: 1.50 m • LENGTH: 1.46 m  
AREA: 2.19 m<sup>2</sup> • PERIMETER: 5.92 m

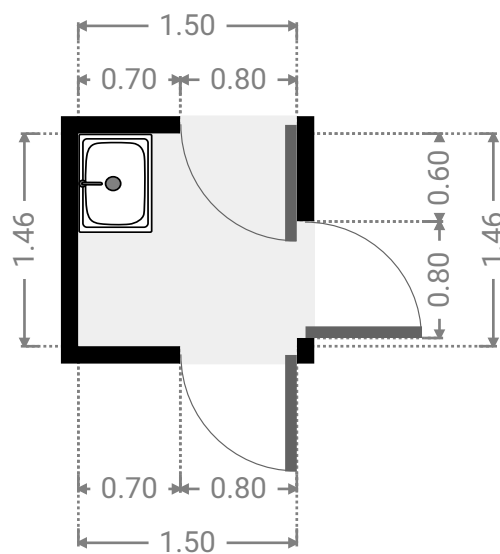
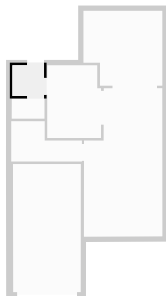

▼ Toilet  
Ground Floor

WIDTH: 1.55 m • LENGTH: 0.96 m  
AREA: 1.48 m<sup>2</sup> • PERIMETER: 5.01 m

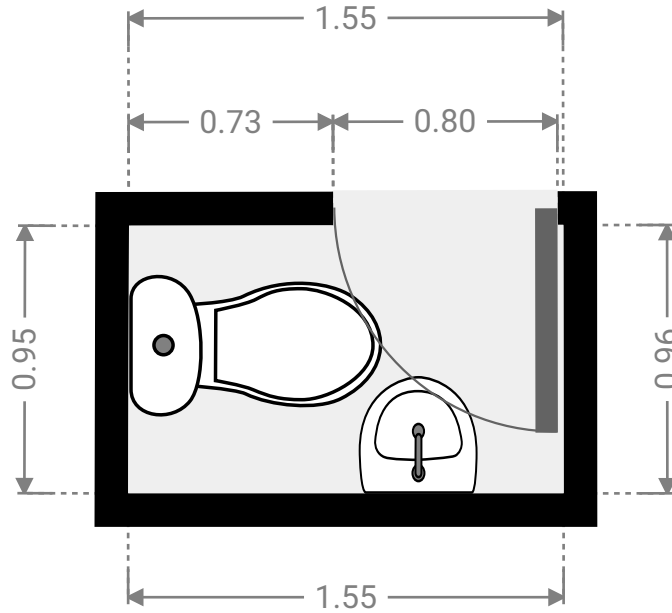
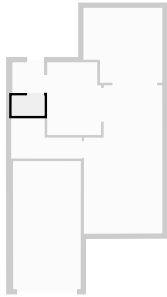

▼ 1st Floor

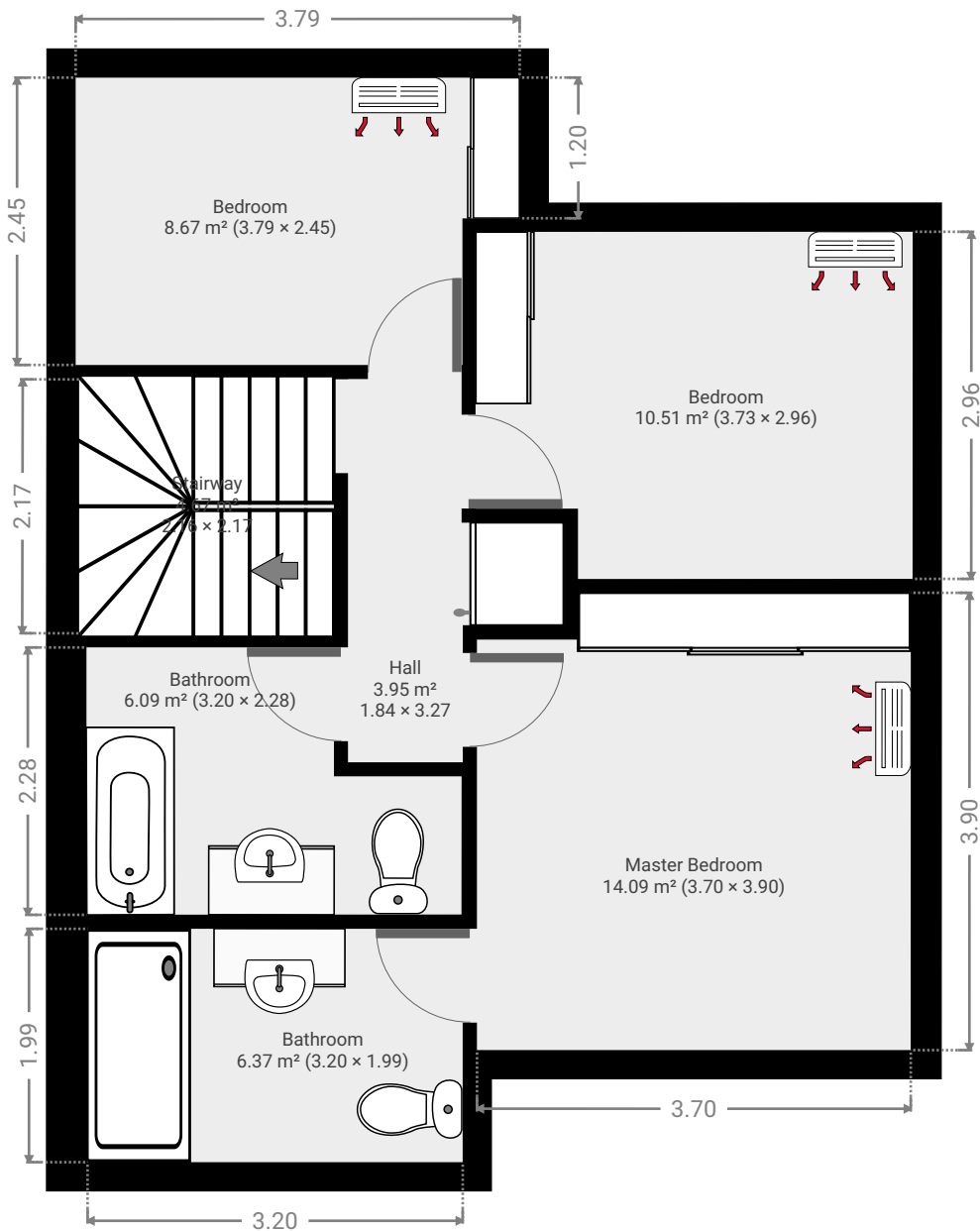

▼ **Hall**  
1st Floor

WIDTH: 1.84 m • LENGTH: 3.01 m  
AREA: 3.95 m<sup>2</sup> • PERIMETER: 10.22 m

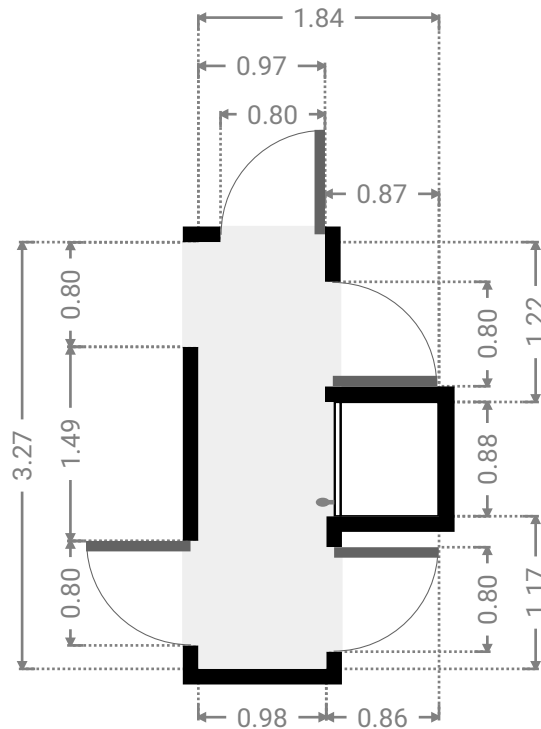
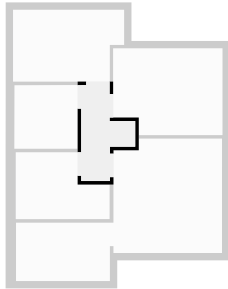

▼ **Bathroom**  
1st Floor

WIDTH: 3.20 m • LENGTH: 2.28 m  
AREA: 6.09 m<sup>2</sup> • PERIMETER: 10.96 m

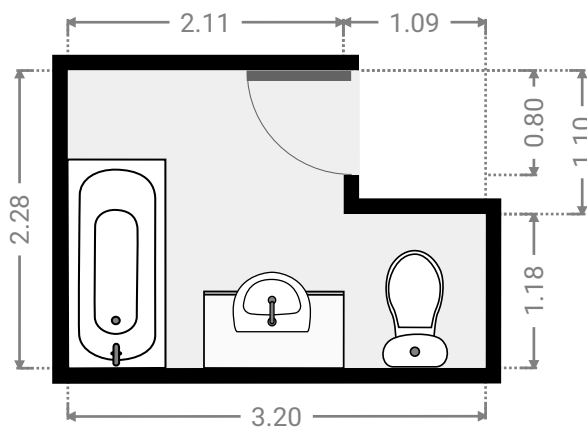
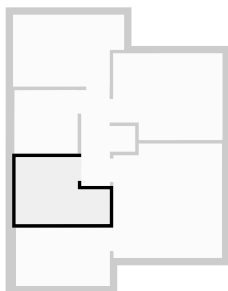



▼ **Master Bedroom**  
1st Floor

WIDTH: 3.70 m • LENGTH: 3.90 m  
AREA: 14.09 m<sup>2</sup> • PERIMETER: 15.20 m

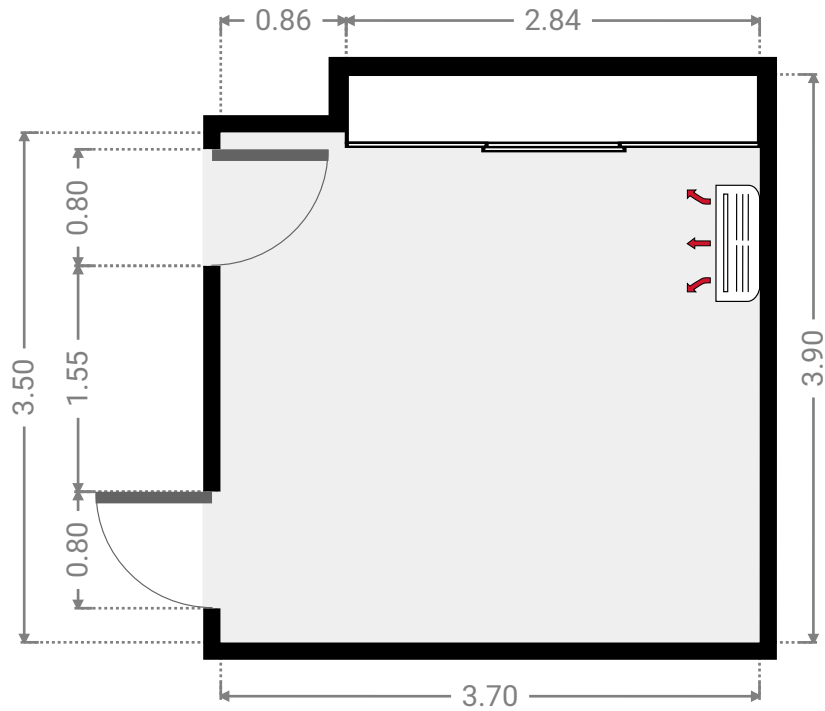
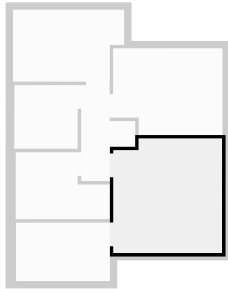

▼ **Bathroom**  
1st Floor

WIDTH: 3.20 m • LENGTH: 1.99 m  
AREA: 6.37 m<sup>2</sup> • PERIMETER: 10.38 m

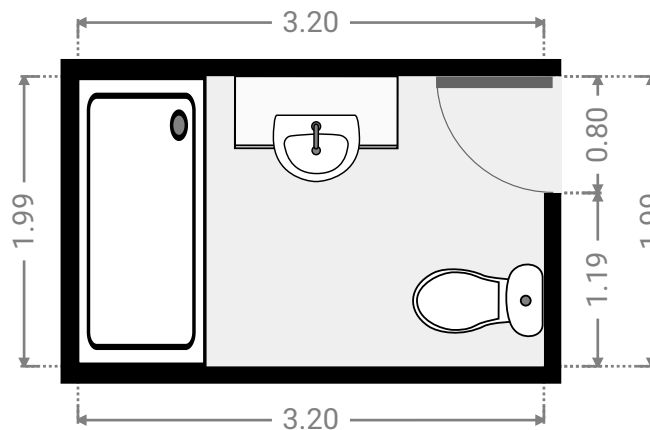
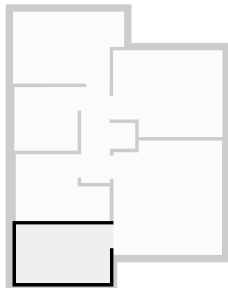

▼ **Bedroom**  
1st Floor

WIDTH: 3.73 m • LENGTH: 2.96 m  
AREA: 10.51 m<sup>2</sup> • PERIMETER: 13.38 m

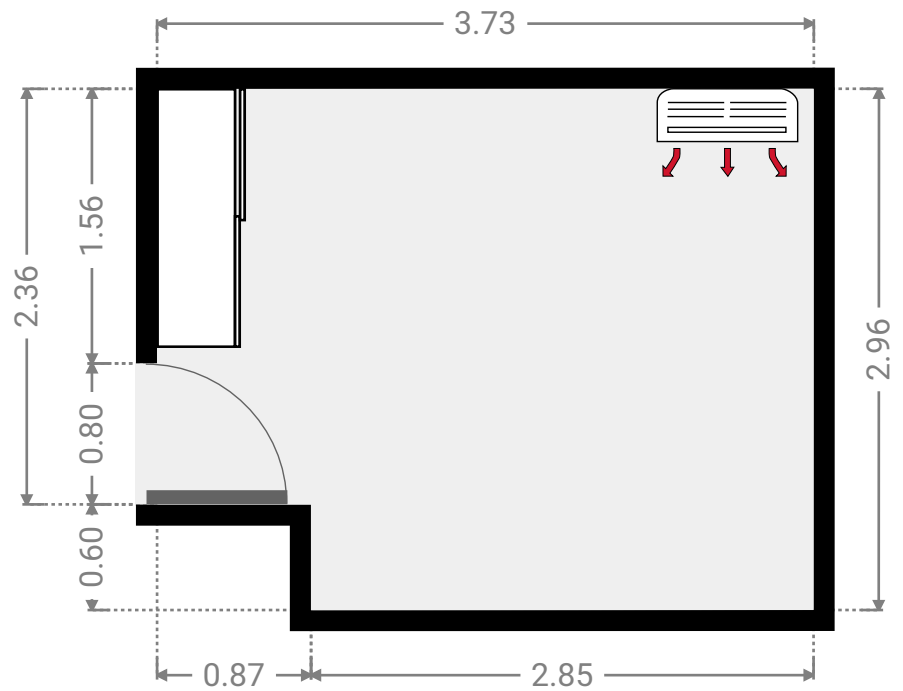
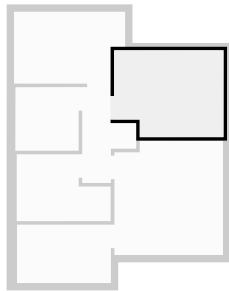

▼ **Bedroom**  
1st Floor

WIDTH: 3.78 m • LENGTH: 2.45 m  
AREA: 8.67 m<sup>2</sup> • PERIMETER: 12.48 m

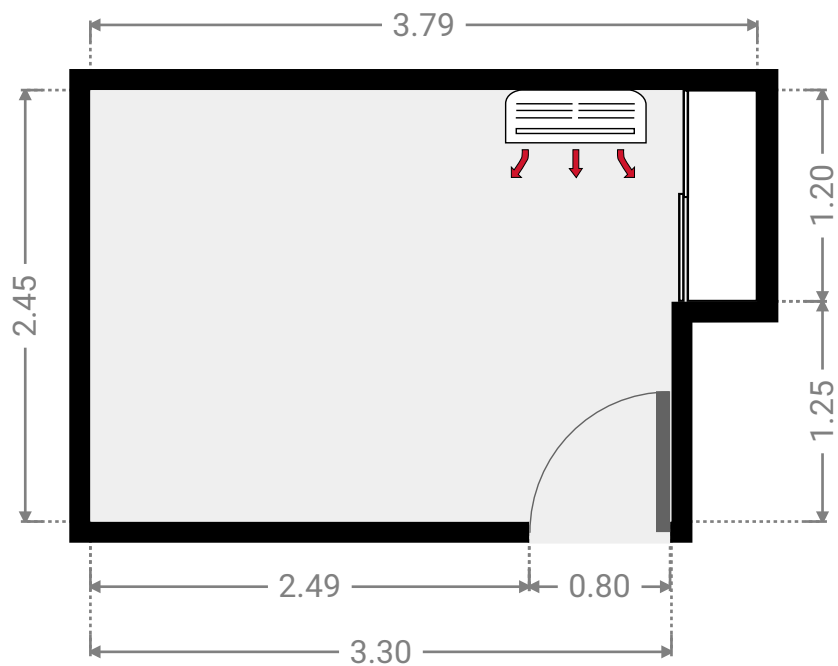
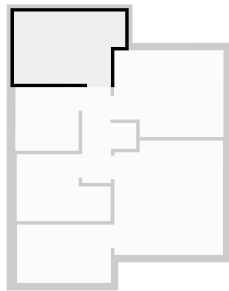

▼ **Stairway**  
1st Floor

WIDTH: 2.16 m • LENGTH: 2.17 m  
AREA: 4.67 m<sup>2</sup> • PERIMETER: 8.65 m

